



# Maintenance and Service Guide

Victus by HP 16.1 inch Gaming Laptop PC

Model numbers: 16-r0xxx

## **SUMMARY**

This guide provides maintenance information about such topics as spare parts, removal and replacement of parts, security, and backing up.

© Copyright 2023 HP Development Company, L.P.

Bluetooth is a trademark owned by its proprietor and used by HP Inc. under license. The terms HDMI, HDMI High-Definition Multimedia Interface, and the HDMI Logo are trademarks or registered trademarks of HDMI Licensing Administrator, Inc. Intel, Core, and Iris are trademarks of Intel Corporation or its subsidiaries in the U.S. and/or other countries. MediaTek is a trademark of MediaTek Inc. Microsoft and Windows are either registered trademarks or trademarks of Microsoft Corporation in the United States and/or other countries. NVIDIA and GeForce are trademarks and/or registered trademarks of NVIDIA Corporation in the U.S. and other countries. NVMe is a registered trademark of NVM Express. PCIe is a US registered trademark and/or service mark of PCI-SIG. USB Type-C and USB-C are registered trademarks of USB Implementers Forum. DisplayPort™ and the DisplayPort™ logo are trademarks owned by the Video Electronics Standards Association (VESA®) in the United States and other countries. Miracast and Wi-Fi are registered trademarks of Wi-Fi Alliance®.

The information contained herein is subject to change without notice. The only warranties for HP products and services are set forth in the express warranty statements accompanying such products and services. Nothing herein should be construed as constituting an additional warranty. HP shall not be liable for technical or editorial errors or omissions contained herein.

First Edition: March 2023

Document Part Number: N36412-001

## Product notice

This guide describes features that are common to most models. Some features may not be available on your computer.

Not all features are available in all editions or versions of Windows. Systems may require upgraded and/or separately purchased hardware, drivers, software or BIOS update to take full advantage of Windows functionality. Windows is automatically updated, which is always enabled. High-speed internet and Microsoft account required. ISP fees may apply and additional requirements may apply over time for updates. See <http://www.microsoft.com>.

### **If your product ships with Windows in S**

**Mode:** Windows in S Mode works exclusively with apps from the Microsoft Store within Windows. Certain default settings, features, and apps cannot be changed. Some accessories and apps that are compatible with Windows may not work (including some antivirus, PDF writers, driver utilities, and accessibility apps), and performance may vary, even if you switch out of S Mode. If you switch to Windows, you cannot switch back to S Mode. Learn more at [Windows.com/SmodeFAQ](http://Windows.com/SmodeFAQ).

To access the latest user guides, go to <http://www.hp.com/support>, and follow the instructions to find your product. Then select **Manuals**.

## Software terms

By installing, copying, downloading, or otherwise using any software product preinstalled on this computer, you agree to be bound by the terms of the HP End User License Agreement (EULA). If you do not accept these license terms, your sole remedy is to return the entire unused product (hardware and software) within 14 days for a full refund subject to the refund policy of your seller.

For any further information or to request a full refund of the price of the computer, please contact your seller.

## Safety warning notice

Reduce the possibility of heat-related injuries or of overheating the computer by following the practices described.

---

**⚠ WARNING!** To reduce the possibility of heat-related injuries or of overheating the computer, do not place the computer directly on your lap or obstruct the computer air vents. Use the computer only on a hard, flat surface. Do not allow another hard surface, such as an adjoining optional printer, or a soft surface, such as pillows or rugs or clothing, to block airflow. Also, do not allow the AC adapter to come into contact with the skin or a soft surface, such as pillows or rugs or clothing, during operation. The computer and the AC adapter comply with the user-accessible surface temperature limits defined by applicable safety standards.

---

## Important notice about Customer Self-Repair parts

Your computer includes Customer Self-Repair parts and parts that should be accessed by only an authorized service provider.



---

**IMPORTANT:** See "Removal and replacement procedures for Customer Self-Repair parts" for details.

Accessing parts described in "Removal and replacement procedures for authorized service provider parts" can damage the computer or void your warranty.

---

---

# Table of contents

<b>1 Product description</b>	<b>1</b>
<b>2 Getting to know your computer</b>	<b>5</b>
Right side	5
Left side	6
Display	7
Low blue light mode (select products only)	7
Keyboard area	9
Touchpad settings and components	9
Touchpad settings	9
Adjusting touchpad settings	9
Turning on the touchpad	9
Touchpad components	9
Lights	10
Special keys	11
Bottom	13
Rear	14
Labels	14
HP OMEN Gaming Hub	15
<b>3 Illustrated parts catalog</b>	<b>17</b>
Computer major components	17
Display assembly subcomponents	20
Miscellaneous parts	22
<b>4 Removal and replacement procedures preliminary requirements</b>	<b>24</b>
Tools required	24
Service considerations	24
Plastic parts	24
Cables and connectors	24
Drive handling	24
Electrostatic discharge information	25
Generating static electricity	25
Preventing electrostatic damage to equipment	26
Personal grounding methods and equipment	26
Grounding the work area	27
Recommended materials and equipment	27
Cleaning your computer	28
Enabling HP Easy Clean (select products only)	28
Removing dirt and debris from your computer	28

Cleaning your computer with a disinfectant.....	29
Caring for wood veneer (select products only).....	30
Packaging and transporting guidelines.....	30
Accessing support information.....	31
<b>5 Removal and replacement procedures for Customer Self-Repair parts.....</b>	<b>33</b>
Component replacement procedures.....	33
Preparation for disassembly.....	33
Solid-state drive.....	33
Memory modules.....	35
<b>6 Removal and replacement procedures for authorized service provider parts.....</b>	<b>38</b>
Component replacement procedures.....	38
Preparation for disassembly.....	38
Bottom cover.....	38
RJ-45 door.....	40
Battery.....	40
WLAN module.....	42
Speakers.....	43
Touchpad.....	44
Audio board.....	46
Heat sink.....	47
System board with heat sink.....	48
Fans.....	51
USB/network board.....	52
IR board.....	53
Display assembly.....	54
Power connector cable.....	62
Top cover with keyboard.....	63
<b>7 Using Setup Utility (BIOS).....</b>	<b>65</b>
Starting Setup Utility (BIOS).....	65
Updating Setup Utility (BIOS).....	65
Determining the BIOS version.....	65
Preparing for a BIOS update.....	66
Downloading a BIOS update.....	66
Installing a BIOS update.....	66
<b>8 Backing up, restoring, and recovering.....</b>	<b>68</b>
Backing up information and creating recovery media.....	68
Using Windows tools for backing up.....	68
Using the HP Cloud Recovery Download Tool to create recovery media (select products only).....	68
Restoring and recovering your system.....	68
Creating a system restore.....	69
Restoring and recovery methods.....	69
Recovering using HP Recovery media.....	69
Changing the computer boot order.....	70
Using HP Sure Recover (select products only).....	70

<b>9 Using HP PC Hardware Diagnostics</b> .....	<b>71</b>
Using HP PC Hardware Diagnostics Windows (select products only).....	71
Using an HP PC Hardware Diagnostics Windows hardware failure ID code.....	71
Accessing HP PC Hardware Diagnostics Windows.....	71
Accessing HP PC Hardware Diagnostics Windows from HP Support Assistant.....	71
Accessing HP PC Hardware Diagnostics Windows from the Start menu (select products only).....	72
Downloading HP PC Hardware Diagnostics Windows.....	72
Downloading the latest HP PC Hardware Diagnostics Windows version from HP.....	72
Downloading the HP PC Hardware Diagnostics Windows from the Microsoft Store.....	72
Downloading HP Hardware Diagnostics Windows by product name or number (select products only).....	72
Installing HP PC Hardware Diagnostics Windows.....	73
Using HP PC Hardware Diagnostics UEFI.....	73
Using an HP PC Hardware Diagnostics UEFI hardware failure ID code.....	73
Starting HP PC Hardware Diagnostics UEFI.....	73
Starting HP PC Hardware Diagnostics UEFI through HP Hotkey Support software (select products only).....	74
Downloading HP PC Hardware Diagnostics UEFI to a USB flash drive.....	74
Downloading the latest HP PC Hardware Diagnostics UEFI version.....	74
Downloading HP PC Hardware Diagnostics UEFI by product name or number (select products only).....	75
Using Remote HP PC Hardware Diagnostics UEFI settings (select products only).....	75
Downloading Remote HP PC Hardware Diagnostics UEFI.....	75
Downloading the latest Remote HP PC Hardware Diagnostics UEFI version.....	75
Downloading Remote HP PC Hardware Diagnostics UEFI by product name or number.....	75
Customizing Remote HP PC Hardware Diagnostics UEFI settings.....	76
<b>10 Specifications</b> .....	<b>77</b>
Computer specifications.....	77
40.9 cm (16.1 in) display specifications.....	77
Solid-state drive specifications.....	78
<b>11 Power cord set requirements</b> .....	<b>79</b>
Requirements for all countries.....	79
Requirements for specific countries and regions.....	79
<b>12 Recycling</b> .....	<b>81</b>
<b>Index</b> .....	<b>82</b>

# 1 Product description

This table provides detailed product information.

**Table 1-1 Product components and their descriptions**

Category	Description
<b>Product Name</b>	<b>Victus by HP 16.1 inch Gaming Laptop PC</b> Model numbers: 16-r0xxx CTO: 16t-r000
<b>Processors</b>	<b>Intel® processors</b> Intel Core® i7-13700HX (2.1 GHz), 30 MB L3 cache, 16 core, 55W Intel Core i7-13700H (2.4 GHz), 24 MB L3 cache, 14 core, 45W Intel Core i5-13500HX (2.5 GHz), 24 MB L3 cache, 14 core, 55W Intel Core i5-13500H (2.6 GHz), 18 MB L3 cache, 12 core, 45W
<b>Graphics</b>	<b>Internal graphics</b> Intel UHD Graphics Intel Iris® Xe <b>Discrete graphics</b> NVIDIA® GeForce® RTX 4070 8 GB NVIDIA GeForce RTX 4060 8 GB NVIDIA GeForce RTX 4050 6 GB NVIDIA GeForce RTX 3050 6 GB
<b>Display</b>	<b>40.9 cm (16.1 in ), antiglare, WLED, flat (3.2 mm), narrow bezel</b> Full high-definition (FHD) (1920 × 1080), Ultra Wide Viewing Angle (UWVA), NTSC 45, eDP 1.3, 250 nits, 144 Hz FHD, UWVA, sRGB 100, eDP 1.2 without PSR, 300 nits FHD, UWVA, sRGB 100, low blue light, eDP 1.3 + PSR, 300 nits, 144 Hz FHD, UWVA, sRGB 100, low blue light, eDP 1.4 without PSR, 300 nits, 165 Hz Quad high-definition (QHD) (2560 × 1440), UWVA sRGB 100, low blue light, eDP 1.4 + PSR, 300 nits, 165 Hz QHD, UWVA sRGB 100, low blue light, eDP 1.4 without PSR, 300 nits, 240 Hz

**Table 1-1 Product components and their descriptions (continued)**

Category	Description
<b>Memory</b>	Customer accessible or upgradeable
	Two SODIMM slots, dual-channel support
	DDR5-5200 or DDR5-4800, 1.1 v
	Supports the following configurations:
	<ul style="list-style-type: none"> <li>• 32 GB (16 × 2)</li> <li>• 16 GB (8 × 2)</li> </ul>
<b>Primary storage</b>	<b>PCIe®, NVMe®, M.2 2280 solid-state drives</b>
	1 TB, PCIe-4 × 4, TLC
	512 GB, PCIe-4 × 4, TLC
<b>Audio and video</b>	B&O HD Audio
	Dual speakers
	Support for HP Audio Boost
	<b>HP True Vision FHD Camera:</b> indicator LED, USB 2.0, HD BSI sensor, f2.0, WDR/TNR, 80° NFOV
	1080p by 30 frames per second
	Dual-array digital microphone with appropriate software: beam forming, echo cancellation, noise suppression
<b>RJ-45/network jack</b>	Integrated 10/100/1000 NIC
<b>Sensor</b>	IR thermal sensor
<b>Wireless</b>	Compatible with Miracast® devices
	Supports Modern Standby (connected)
	<b>Integrated wireless options with dual antennas</b>
	MediaTek™ MT7921 Wi-Fi® 6 Bluetooth® 5.3 WW WLAN
	Intel AX211 Wi-Fi 6E Bluetooth 5.3 WW WLAN
<b>Ports</b>	HDMI® v2.1 supporting: up to 7680 × 4320 @ 60 Hz, 4096 × 2160 @ 60 Hz, 7680 × 4320 @ 30 Hz
	Audio-out (headphone)/audio-in (microphone) combo jack
	RJ-45 connector
	USB 3.2 Gen 1 Type-C, right side, supports:
	- power delivery
	- data transfer
	- HP Sleep & Charge
	- DisplayPort™ 1.4 out up to 5120 × 2880 @ 60 Hz
	- HDMI 2.1 out up to 5120 × 2880 @ 60 Hz with HDCP 2.3)
(3) USB 3.2 Gen 1 Type-A (2 right side, 1 left side, supports HP Sleep & Charge)	
AC Smart Pin adapter plug	

**Table 1-1 Product components and their descriptions (continued)**

Category	Description
<b>Keyboard/pointing devices</b>	<b>Keyboard</b>
	Full size, backlit, island-style with numeric keypad, 1-zone RGB
	Full size, backlit, island-style with numeric keypad
	<b>Clickpad</b>
	Image sensor
	Multitouch gestures enabled
	Precision touchpad support
	Support for modern trackpad gestures
Taps enabled as default	
<b>Power requirements</b>	<b>Battery</b> (lithium-polymer)
	4 cell, 70 Whr
	6 cell, 83 Whr
	HP long life
	HP Fast Charge Technology
	<b>Smart AC adapters</b> (PFC, 4.5 mm)
	230 W, right angle
	200 W, right angle
	<b>Power cord</b>
	C13, premium, 1 m (3.3 ft)
<b>Security</b>	Supports Trusted Platform Module (fTPM) 2.0, firmware based
	Camera privacy cover
<b>Operating system</b>	Windows® 11 Home 64 Advanced
	Windows 11 Home 64 Advanced Single Language
	Windows 11 Home 64 High-end Chinese Market CPPP
	Windows 11 Home 64 Plus
	Windows 11 Home 64 Plus Single Language
	Windows 11 Home 64 Plus Single Language Africa Market PPP
	Windows 11 Home 64 Plus Single Language APAC EM PPP
	Windows 11 Home 64 Plus Single Language India Market PPP
	Windows 11 Home 64 Plus Single Language Indonesia Market PPP
	Windows 11 Pro 64
	FreeDOS 3.0

**Table 1-1** Product components and their descriptions (continued)

<b>Category</b>	<b>Description</b>
<b>Serviceability</b>	<b>End user replaceable parts</b>
	AC adapter
	Solid-state drive
	Memory modules

## 2 Getting to know your computer



Your computer features top-rated components. This chapter provides details about your components, where they are located, and how they work.

### Right side

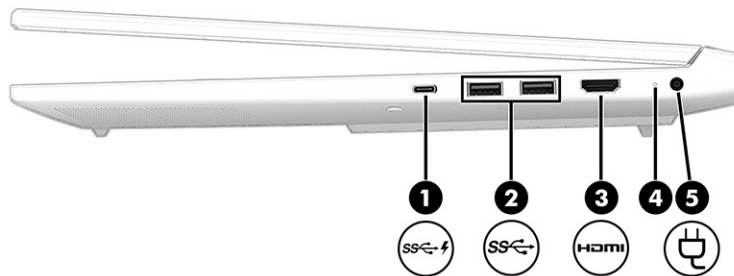
Identify the components on the right side of the computer.



**Table 2-1** Right-side components and their descriptions

Component	Description
<p>(1)</p> 	<p>USB Type-C® 5 Gbps signaling rate power connector port with HP Sleep and Charge and DisplayPort™ output</p> <p>Connects an AC adapter that has a USB Type-C connector, supplying power to the computer and, if needed, charging the computer battery.</p> <p>- and -</p> <p>Connects a USB device, provides high-speed data transfer, and charges small devices (such as a smartphone), even when the computer is off.</p> <p><b>NOTE:</b> Use a standard USB Type-C charging cable or cable adapter (purchased separately) when charging a small external device.</p> <p>- and -</p> <p>Connects a display device that has a USB Type-C connector, providing DisplayPort output.</p>
<p>(2)</p> 	<p>USB port with 5 Gbps signaling rate (2)</p> <p>Connect a USB device, provides high-speed data transfer, and (for select products) charges small devices (such as a smartphone) when the computer is on or in Sleep mode.</p> <p><b>NOTE:</b> Use a standard USB Type-A charging cable or cable adapter (purchased separately) when charging a small external device.</p>
<p>(3)</p> 	<p>HDMI® port</p> <p>Connects an optional video or audio device, such as a high-definition television, any compatible digital or audio component, or a high-speed High-Definition Multimedia Interface® (HDMI) device.</p>

**Table 2-1** Right-side components and their descriptions (continued)



Component	Description
(4) AC adapter and battery light	<ul style="list-style-type: none"> <li>White: The AC adapter is connected and the battery is fully charged.</li> <li>Blinking amber: The AC adapter is disconnected and the battery has reached a low battery level.</li> <li>Amber: The AC adapter is connected and the battery is charging.</li> <li>Off: The battery is not charging.</li> </ul>
(5)  Power connector	Connects an AC adapter.

## Left side

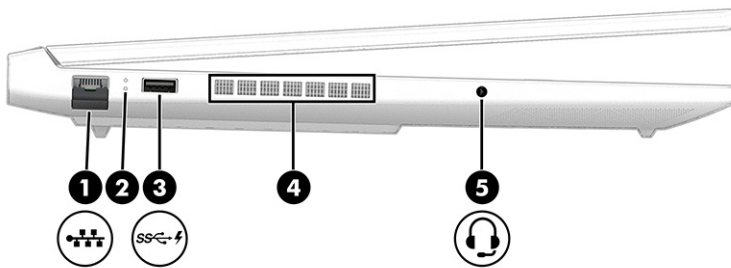
Identify the components on the left side of the computer.



**Table 2-2** Left-side components and their descriptions

Component	Description
(1)  RJ-45 (network) jack	Connects a network cable.
(2) RJ-45 (network) status lights	<ul style="list-style-type: none"> <li>White: The network is connected.</li> <li>Amber: Activity is occurring on the network.</li> </ul>
(3)  USB 5 Gbps signaling rate port with HP Sleep and Charge	<p>Connects a USB device, provides high-speed data transfer, and charges small devices (such as a smartphone), even when the computer is off.</p> <p><b>NOTE:</b> Use a standard USB Type-A charging cable or cable adapter (purchased separately) when charging a small external device.</p>
(4) Vent (select products only)	<p>Enables airflow to cool internal components.</p> <p><b>NOTE:</b> The computer fan starts up automatically to cool internal components and prevent overheating. It is normal for the internal fan to cycle on and off during routine operation.</p>

**Table 2-2 Left-side components and their descriptions (continued)**

Component	Description
(5)  Audio-out (headphone)/Audio-in (microphone) combo jack	<p>Connects optional powered stereo speakers, headphones, earbuds, a headset, or a television audio cable. Also connects an optional headset microphone. This jack does not support optional standalone microphones.</p> <p><b>WARNING!</b> To reduce the risk of personal injury, adjust the volume before putting on headphones, earbuds, or a headset. For additional safety information, see the <i>Regulatory, Safety, and Environmental Notices</i>.</p> <p>To access this guide:</p> <ul style="list-style-type: none"><li>■ Select the <b>Search</b> icon in the taskbar, type <b>HP Documentation</b> in the search box, and then select <b>HP Documentation</b>.</li></ul> <p><b>NOTE:</b> When a device is connected to the jack, the computer speakers are disabled.</p>

## Display

The computer display can include essential components such as speakers, antennas, cameras, and microphones.

### Low blue light mode (select products only)

Your computer display is shipped from the factory in low blue light mode for improved eye comfort and safety. Also, blue light mode automatically adjusts blue light emissions when you are using the computer at night or for reading.

**⚠ WARNING!** To reduce the risk of serious injury, read the *Safety & Comfort Guide*. It describes proper workstation setup and proper posture, health, and work habits for computer users. The *Safety & Comfort Guide* also provides important electrical and mechanical safety information. The *Safety & Comfort Guide* is available on the web at <http://www.hp.com/ergo>.

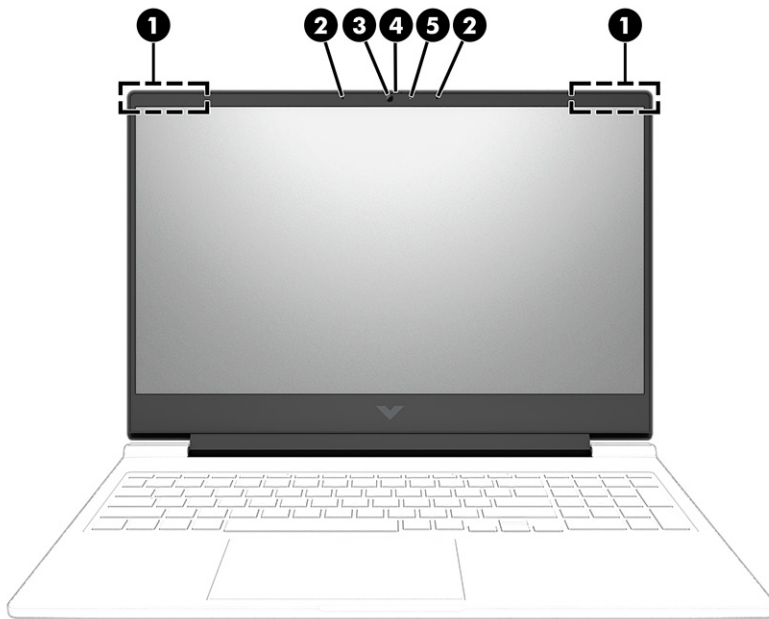

**Table 2-3** Display components and their descriptions

Component	Description
(1) WLAN antennas*	Send and receive wireless signals to communicate with wireless local area networks (WLANs).
(2) Internal microphones (2)	Record sound.
(3) Camera	Allows you to video chat, record video, and record still images. Some cameras also allow a facial recognition logon to Windows®, instead of a password logon.  <b>NOTE:</b> Camera functions vary depending on the camera hardware and software installed on your product.
(4) Camera privacy cover	By default, the camera lens is uncovered, but you can slide the camera privacy cover to block the camera's view. To use the camera, slide the camera privacy cover in the opposite direction to reveal the lens.  <b>NOTE:</b> If you have both front-facing and rear-facing cameras, when one camera lens is revealed and ready to use, the other is concealed.
(5) Camera light	On: The camera is in use.

\*The antennas are not visible from the outside of the computer. For optimal transmission, keep the areas immediately around the antennas free from obstructions.

For wireless regulatory notices, see the section of the *Regulatory, Safety, and Environmental Notices* that applies to your country or region.

To access this guide:

- Select the **Search** icon in the taskbar, type `HP Documentation` in the search box, and then select **HP Documentation**.

# Keyboard area

Keyboards can vary by language.



**NOTE:** The keyboard area, including the function keys and (select products only) power key, is disabled in stand, tent, and tablet modes. To enable the keyboard, including the power key, change to the clamshell mode.

---

## Touchpad settings and components

Learn the touchpad settings and components.

### Touchpad settings

Learn how to adjust touchpad settings.

#### Adjusting touchpad settings

Use these steps to adjust touchpad settings and gestures.

1. Select the **Search** icon in the taskbar, type `touchpad settings` in the search box, and then press `enter`.
2. Choose a setting.

#### Turning on the touchpad

Follow these steps to turn on the touchpad.

1. Select the **Search** icon in the taskbar, type `touchpad settings` in the search box, and then press `enter`.
2. Using an external mouse, click the **touchpad** button.

If you are not using an external mouse, press the **Tab** key repeatedly until the pointer rests on the **touchpad** button. Then press the `spacebar` to select the button.

### Touchpad components

Identify the touchpad components.

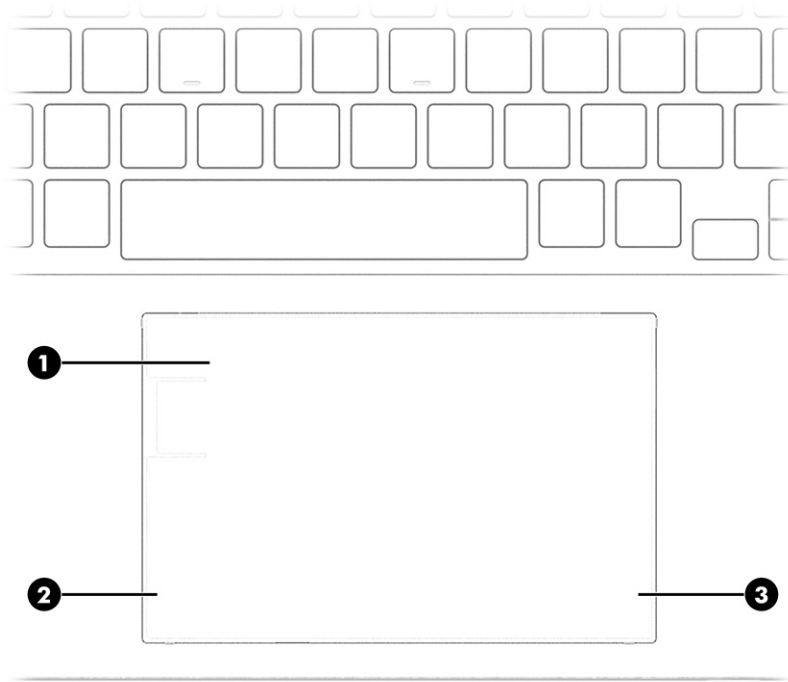
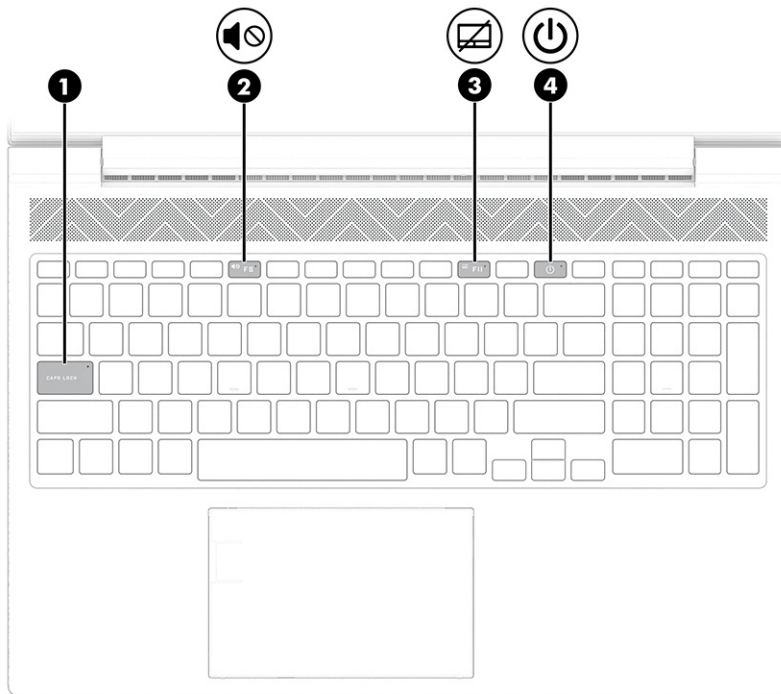

**Table 2-4** Touchpad components and their descriptions



Component	Description
(1) Touchpad zone	Reads your finger gestures to move the pointer or activate items on the screen.
(2) Left control zone	Textured area that allows you to perform additional gestures.
(3) Right control zone	Textured area that allows you to perform additional gestures.

## Lights

Identify the lights on the computer.

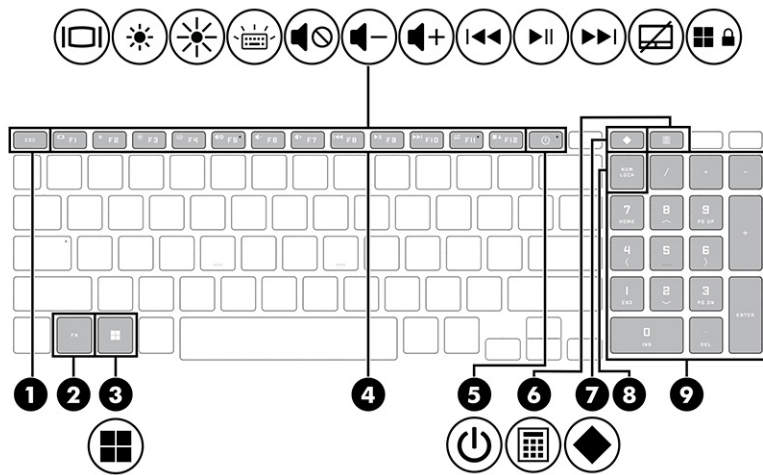

**Table 2-5** Lights and their descriptions





Component		Description
(1)	Caps lock light	On: Caps lock is on, which switches the key input to all capital letters.
(2)	 Mute light	<ul style="list-style-type: none"> <li>On: Computer sound is off.</li> <li>Off: Computer sound is on.</li> </ul>
(3)	 Touchpad light	<ul style="list-style-type: none"> <li>On: The touchpad is off.</li> <li>Off: The touchpad is on.</li> </ul>
(4)	 Power light	<ul style="list-style-type: none"> <li>On: The computer is on.</li> <li>Blinking (select products only): The computer is in the Sleep state, a power-saving state. The computer shuts off power to the display and other unnecessary components.</li> <li>Off: Depending on your computer model, the computer is off, in Hibernation, or in Sleep. Hibernation is the power-saving state that uses the least amount of power.</li> </ul>

## Special keys

Identify the special keys.



**Table 2-6** Special keys and their descriptions

Component	Description
(1)  <code>esc</code> key	Displays system information when pressed in combination with the <code>fn</code> key.
(2) <code>fn</code> key	Executes specific functions when pressed in combination with another key.
(3)  Windows key	Opens the Start menu.  <b>NOTE:</b> Pressing the Windows key again will close the Start menu.
(4) Action keys	Execute frequently used system functions as defined by the icon symbols on <code>f1</code> through <code>f12</code> function keys.
(5)  Power button	<ul style="list-style-type: none"> <li>When the computer is off, press the button briefly to turn on the computer.</li> <li>When the computer is on, press the button briefly to initiate Sleep.</li> <li>When the computer is in the Sleep state, press the button briefly to exit Sleep (select products only).</li> <li>When the computer is in Hibernation, press the button briefly to exit Hibernation.</li> </ul> <p><b>IMPORTANT:</b> Pressing and holding down the power button results in the loss of unsaved information.</p> <p>If the computer has stopped responding and shutdown procedures are ineffective, press and hold the power button down for at least 10 seconds to turn off the computer.</p> <p>To learn more about your power settings, see your power options:</p> <ul style="list-style-type: none"> <li>Right-click the <b>Power</b> icon , and then select <b>Power Options</b>.</li> </ul>
(6)  Calculator key	Opens the calculator.

**Table 2-6** Special keys and their descriptions (continued)

Component	Description
(7)  OMEN key	Opens the OMEN Gaming Hub software.  See <a href="#">HP OMEN Gaming Hub on page 15</a> for more information.
(8) num lock key	Alternates between the navigational and numeric functions on the integrated numeric keypad.
(9) Integrated numeric keypad	A separate keypad to the right of the alphabet keyboard. When num lock is pressed, the keypad can be used like an external numeric keypad.  <b>NOTE:</b> If the keypad function is active when the computer is turned off, that function is reinstated when the computer is turned back on.

## Bottom

Identify the bottom components.

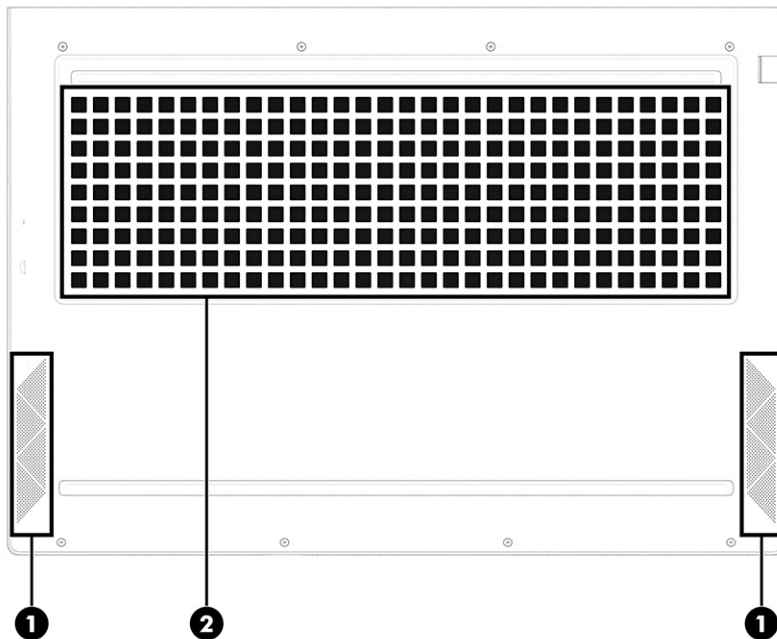

**Table 2-7** Bottom components and their descriptions

Component	Description
(1) Speakers (2)	Produce sound.
(2) Vent	Enables airflow to cool internal components.  <b>NOTE:</b> The computer fan starts up automatically to cool internal components and prevent overheating. It is normal for the internal fan to cycle on and off during routine operation.

## Rear

Use the illustration and table to identify the rear component.



**Table 2-8** Rear component and its description

Component	Description
Vent	Enables airflow to cool internal components.  <b>NOTE:</b> The computer fan starts up automatically to cool internal components and prevent overheating. It is normal for the internal fan to cycle on and off during routine operation.

## Labels

The labels affixed to the computer provide information that you might need when you troubleshoot system problems or travel internationally with the computer. Labels can be in paper form or imprinted on the product.

 **IMPORTANT:** Check the following locations for the labels described in this section: the bottom of the computer, inside the battery bay, under the service door, on the back of the display, or on the bottom of a tablet kickstand.

- Service label—Provides important information to identify your computer. When contacting support, you might be asked for the serial number, the product number, or the model number. Locate this information before you contact support.

Your service label will resemble one of the following examples. Refer to the illustration that most closely matches the service label on your computer.



**Table 2-9** Service label components

Component
(1) Serial number
(2) Product ID
(3) HP product name and model number

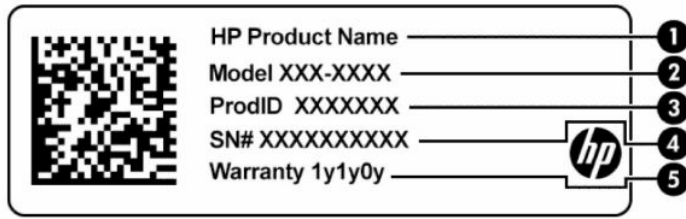

**Table 2-10** Service label components

Component	
(1)	HP product name
(2)	Model number
(3)	Product ID
(4)	Serial number
(5)	Warranty period

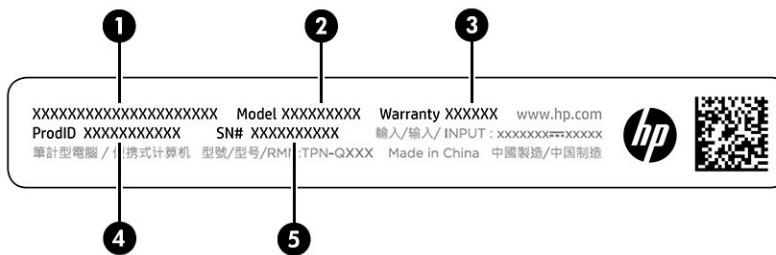

**Table 2-11** Service label components

Component	
(1)	HP product name
(2)	Model number
(3)	Warranty period
(4)	Product ID
(5)	Serial number

- Regulatory labels—Provide regulatory information about the computer.
- Wireless certification labels—Provide information about optional wireless devices and the approval markings for the countries or regions in which the devices have been approved for use.

## HP OMEN Gaming Hub

HP OMEN Gaming Hub allows you to customize your computer for your specific gaming needs. Some features are available on select products only.

- Start HP OMEN Gaming Hub in one of the following ways:
  - Select the **Search** icon in the taskbar, type `OMEN Gaming Hub` in the search box, and then press `enter`.
    - or -
  - Select the **Start** button, under **Top apps**, select **OMEN Gaming Hub**, and then follow the on-screen instructions.
    - or -
  - Press the **OMEN** key  at the top-right side of the keyboard.

The HP OMEN Gaming Hub dashboard provides a central location to access and configure the following features:

- **Cam & Voice Enhancer:** Improve your streaming quality with AI-powered video and audio effects and enhancements (NVIDIA® RTX GPUs only).
- **System Vitals:** Monitor the computer status and performance.
- **Undervolting:** Adjust the voltage of the computer to use less power and decrease the amount of heat generated.
- **Light Studio:** Coordinate your color scheme and easily sync your lighting effects across your OMEN devices.
- **Rewards:** Join daily challenges to win in-game items and exclusive prizes.
- **Lighting:** Customize the keyboard lighting.
- **Network Booster:** View and adjust network priorities and settings.
- **Performance Control:** Optimize the performance of your computer for the task you are performing.
- **Gaming Device Lighting and Macros:** Configure the lighting and macro keys when an external supported gaming device is connected (select products only).
- **Remote Play:** Manage and access your game library from one location.
- **OMEN Game Stream:** Provide the ability to stream games to other devices.
- **Help:** Access “How to” information and frequently asked questions.



---

**NOTE:** To minimize the dashboard, select the arrow button < at the top of the dashboard.

---

# 3 Illustrated parts catalog

Use this chapter to determine the spare parts that are available for the computer.

## Computer major components

To identify the computer major components, use this illustration and table.

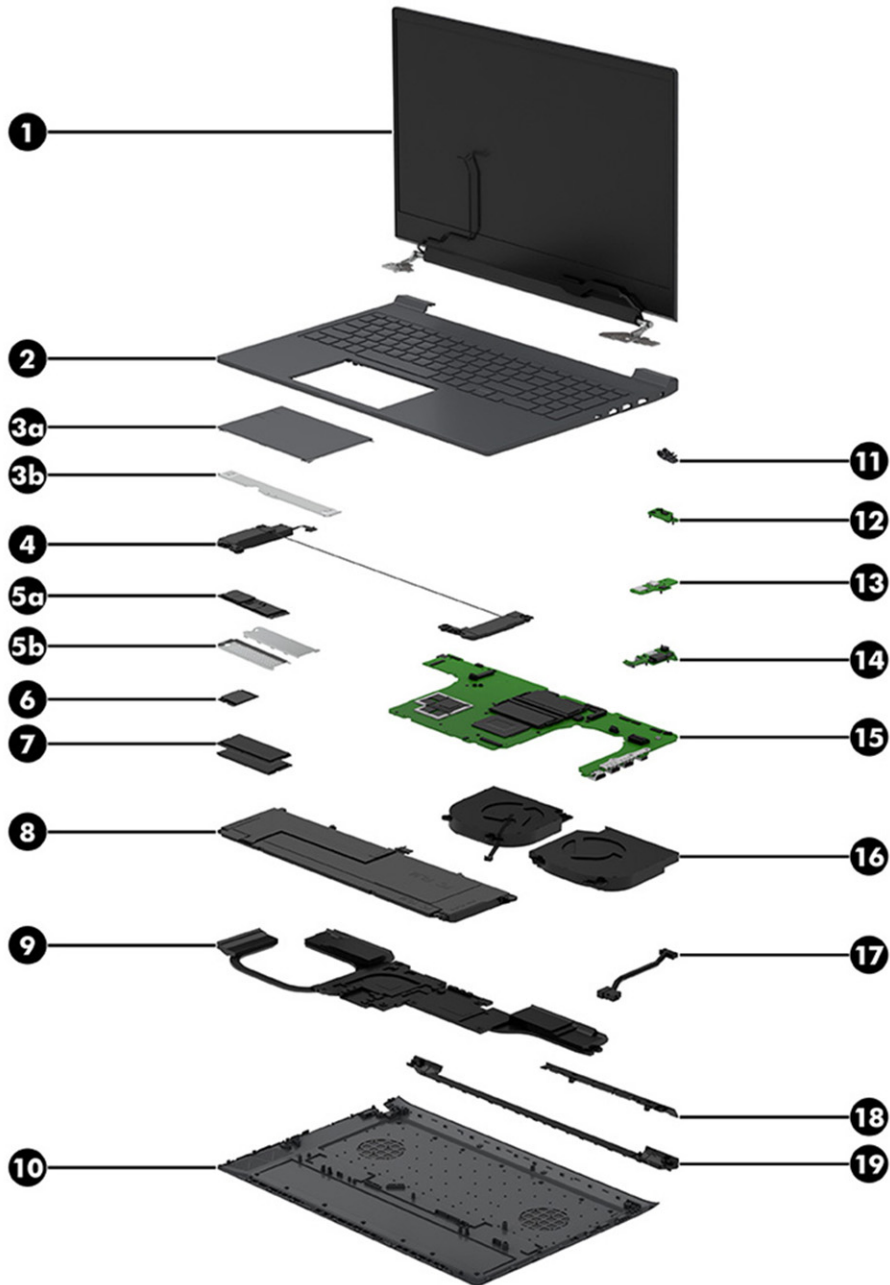

**Table 3-1 Computer major component descriptions and part numbers**

Item	Component	Spare part number
(1)	<b>Display assembly</b>  <b>NOTE:</b> Display assemblies are offered as spare parts only at a subcomponent level. For more information, see <a href="#">Display assembly subcomponents on page 20</a> .	not available as a spare part
(2)	<b>Top cover with keyboard</b>  For a detailed list of country codes, see <a href="#">Top cover with keyboard on page 63</a> .	
	Ceramic white, RGB, 80 W models	N42466-xxx
	Ceramic white, RGB, 60 W models	N42467-xxx
	Performance blue, RGB, 80 W models	N42468-xxx
	Performance blue, 80 W models	N42469-xxx
	Performance blue, RGB, 60 W models	N42470-xxx
	Performance blue, 60 W models	N42471-xxx
	Mica silver, RGB, 80 W models	N42472-xxx
	Mica silver, RGB, 60 W models	N42473-xxx
	Mica silver, 80 W models	N42474-xxx
	Mica silver, 60 W models	N42472-xxx
(3a)	<b>Touchpad</b> (does not include bracket)  <b>NOTE:</b> The touchpad cable is available using spare part number N42556-001.	
	Ceramic white	N42557-001
	Mica silver	N42559-001
	Performance blue	N42558-001
(3b)	<b>Touchpad bracket</b>	not available as a spare part
(4)	<b>Speakers</b> (left and right)	N49443-001
(5a)	<b>Solid-state drive</b>  <b>NOTE:</b> The solid-state drive thermal pad is available as spare part number N49444-001.	
	1 TB, PCIe-4 × 4, TLC	M16560-001 M16560-005
	512 GB, PCIe-4 × 4, TLC	M17436-001 M17436-005
(5b)	<b>Solid-state drive cover</b>	not available as a spare part
(6)	<b>WLAN module</b>	
	MediaTek MT7921 Wi-Fi® 6 Bluetooth® 5.3 WW WLAN	M74879-005
	Intel AX211 Wi-Fi 6E Bluetooth 5.3 WLAN	M53366-005
(7)	<b>Memory modules</b> (DDR5-5600)	

**Table 3-1 Computer major component descriptions and part numbers (continued)**

<b>Item</b>	<b>Component</b>	<b>Spare part number</b>
	16 GB	N38627-005
	8 GB	N37792-005
<b>(8)</b>	<b>Battery</b>	
	6 cell, 83 Whr	M41711-005
	4 cell, 70 Whr	M39179-005
<b>(9)</b>	<b>Heat sink</b>	
	80 W, HX processors	N42561-001
	80 W, H processors	N42560-001
	60 W, HX processors	N42563-001
	60 W, H processors	N42562-001
<b>(10)</b>	<b>Bottom cover</b>	
	Ceramic white, 80 W	N42542-001
	Mica silver, 80 W	N42544-001
	Performance blue, 80 W	N42543-001
	Ceramic white, 60 W	N57417-001
	Mica silver, 60 W	N57418-001
	Performance blue, 60 W	N57419-001
<b>(11)</b>	<b>RJ-45 door</b>	
	Ceramic white	N49440-001
	Mica silver	N49441-001
	Performance blue	N49442-001
<b>(12)</b>	<b>IR sensor board</b>	N42551-001
	<b>NOTE:</b> The IR sensor board cable is available as spare part number N42554-001.	
<b>(13)</b>	<b>Audio board</b>	N42553-001
	<b>NOTE:</b> The audio board cable is available as spare part number N42553-001.	
<b>(14)</b>	<b>USB board</b>	N42550-001
	<b>NOTE:</b> The USB board cable is available using spare part number N42555-001.	
<b>(15)</b>	<b>System board</b> (includes processor; for use in models with discrete graphics memory)	
	All system boards use the following part numbers:	
	xxxxxx-001: Non-Windows operating system	
	xxxxxx-601: Windows 10 operating system	
	Intel Core i7-13700HX processor and NVIDIA GeForce RTX 4070 graphics	N42529-xx1
	Intel Core i7-13700HX processor and NVIDIA GeForce RTX 4060 graphics	N42527-xx1
	Intel Core i7-13700HX processor and NVIDIA GeForce RTX 4050 graphics	N42525-xx1

**Table 3-1 Computer major component descriptions and part numbers (continued)**

<b>Item</b>	<b>Component</b>	<b>Spare part number</b>
	Intel Core i7-13700HX processor and NVIDIA GeForce RTX 3050 graphics	N42523-001
	Intel Core i5-13500HX processor and NVIDIA GeForce RTX 4070 graphics	N42528-xx1
	Intel Core i5-13500HX processor and NVIDIA GeForce RTX 4060 graphics	N42526-xx1
	Intel Core i5-13500HX processor and NVIDIA GeForce RTX 4050 graphics	N42524-xx1
	Intel Core i5-13500HX processor and NVIDIA GeForce RTX 3050 graphics	N42522-xx1
	Intel Core i7-13700H processor and NVIDIA GeForce RTX 4070 graphics	N42521-xx1
	Intel Core i7-13700H processor and NVIDIA GeForce RTX 4060 graphics	N42520-xx1
	Intel Core i7-13700H processor and NVIDIA GeForce RTX 4050 graphics	N42518-xx1
	Intel Core i7-13700H processor and NVIDIA GeForce RTX 3050 graphics	N42516-xx1
	Intel Core i5-13500H processor and NVIDIA GeForce RTX 4060 graphics	N42519-xx1
	Intel Core i5-13500H processor and NVIDIA GeForce RTX 4050 graphics	N42517-xx1
	Intel Core i5-13500H processor and NVIDIA GeForce RTX 3050 graphics	N42515-xx1
<b>(16)</b>	<b>Fan kit</b> (includes processor fan and graphics fan)	
	80 W	N44738-001
	60 W	N44742-001
<b>(17)</b>	<b>Power connector cable</b>	N42568-001
<b>(18)</b>	<b>Rear bracket</b>	not available as a spare part
<b>(19)</b>	<b>Rear vent</b>	not available as a spare part

## Display assembly subcomponents

To identify the display assembly subcomponents, use this illustration and table.

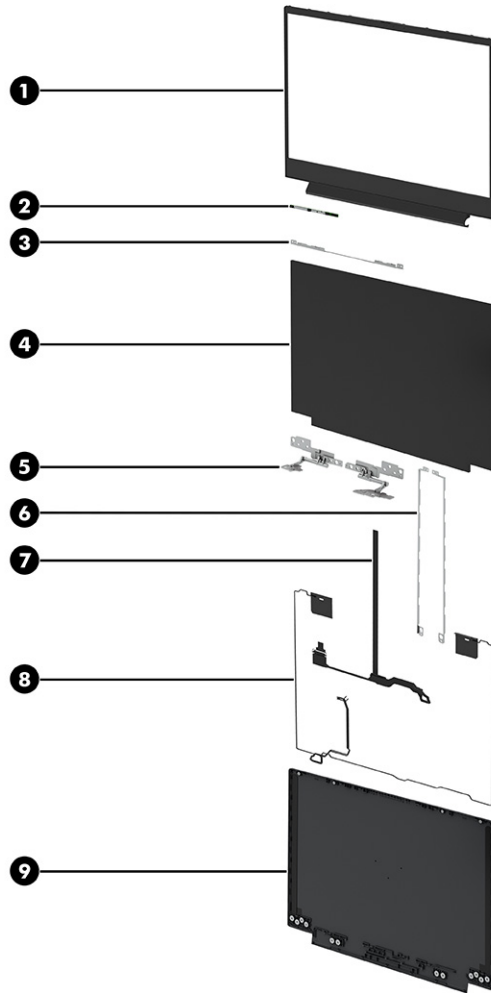

**Table 3-2** Display component descriptions and part numbers

Item	Component	Spare part number
(1)	<b>Display bezel</b> (includes display panel adhesive)	N42541-001
(2)	<b>Camera module</b> (includes display panel adhesive)	N42549-001
(3)	<b>Top bracket</b>	not available as a spare part
(4)	<b>Display panel</b> (includes display cover adhesive and display bezel adhesive)	
	QHD, 300 nits, 144 Hz	N42534-001
	QHD, 300 nits, 165 Hz	N55501-001
	FHD, 300 nits, low blue light (LBL), Dynamic Display Switch (DDS), 165 Hz	N42533-001
	FHD, 300 nits, LBL, 144 Hz	N42532-001
	FHD, 300 nits	N42531-001
	FHD, 250 nits	N42530-001
(5)	<b>Hinges</b> (includes left and right display hinges; includes display panel adhesive)	N42548-001

**Table 3-2** Display component descriptions and part numbers (continued)

Item	Component	Spare part number
(6)	<b>Side brackets</b>	not available as a spare part
(7)	<b>Display panel cable</b> (includes display panel adhesive and display bezel adhesive)	
	For use with FHD panels	N42546-001
	For use with FHD, LBL panels	N42547-001
	For use with QHD panels	N42545-001
(8)	<b>Wireless antenna kit</b> (includes display panel adhesive)	N49447-001
(9)	<b>Display back cover</b> (includes display bezel adhesive)	
	QHD, ceramic white	N42536-001
	FHD, ceramic white	N42535-001
	QHD, mica silver	N42540-001
	FHD, mica silver	N42539-001
	QHD, performance blue	N42538-001
	FHD, performance blue	N42537-001
	<b>Adhesive kit</b> (includes display panel adhesive; not illustrated)	N49445-001

## Miscellaneous parts

To identify the miscellaneous parts, use this table.

**Table 3-3** Miscellaneous part descriptions and part numbers

Component	Spare part number
<b>AC adapters</b> (Smart, PFC, slim)	
230 W	N22367-001
200 W	N43500-001
<b>Screw Kit</b>	N49446-001
<b>HP HDMI-to-VGA adapter</b>	701943-001
<b>Hub, HP USB Type-C-to-USB Type-A</b>	916838-001
<b>Hub, HP Elite USB-C* multiport</b>	L39572-001
<b>LCD Adhesive Kit</b>	N49445-001
<b>External DVD±RW drive</b>	747080-001
<b>Power cords</b> (C13, premium, 1.0 m [3.3 ft])	
Argentina	L22104-001
Australia	L22339-001
Denmark	L22334-001
Europe (Austria, Belgium, Finland, France, Germany, the Netherlands, Norway, and Sweden)	L22333-001

**Table 3-3** Miscellaneous part descriptions and part numbers (continued)

<b>Component</b>	<b>Spare part number</b>
India	L22343-001
Israel	L22335-001
Italy	L22103-001
Japan	L22344-001
North America	L22331-001 L63255-001
People's Republic of China	L22341-001
South Africa	L22337-001
South Korea	L22340-001
Switzerland	L22336-001
Taiwan	L22342-001
Thailand	L22338-001
Thailand, bundle	M85413-001
United Kingdom	L22332-001

---

# 4 Removal and replacement procedures preliminary requirements

Use this information to properly prepare to disassemble and reassemble the computer.

## Tools required

You need the following tools to complete the removal and replacement procedures:

- Tweezers
- Nonconductive, nonmarking pry tool
- Magnetic Phillips P1 screwdriver

## Service considerations

The following sections include some of the considerations that you must keep in mind during disassembly and assembly procedures.

---

 **NOTE:** As you remove each subassembly from the computer, place the subassembly (and all accompanying screws) away from the work area to prevent damage.

---

## Plastic parts

Using excessive force during disassembly and reassembly can damage plastic parts.

## Cables and connectors

Handle cables with extreme care to avoid damage.

---

 **IMPORTANT:** When servicing the computer, be sure that cables are placed in their proper locations during the reassembly process. Improper cable placement can damage the computer.

---

Apply only the tension required to unseat or seat the cables during removal and insertion. Handle cables by the connector whenever possible. In all cases, avoid bending, twisting, or tearing cables. Be sure that cables are routed so that they cannot be caught or snagged as you remove or replace parts. Handle flex cables with extreme care; these cables tear easily.

## Drive handling

Note the following guidelines when handling drives.

---

 **IMPORTANT:** Drives are fragile components. Handle them with care. To prevent damage to the computer, damage to a drive, or loss of information, observe these precautions:

- Before removing or inserting a hard drive, shut down the computer. If you are unsure whether the computer is off or in Hibernation, turn the computer on, and then shut it down through the operating system.

- Before handling a drive, be sure that you are discharged of static electricity. While handling a drive, avoid touching the connector.
  - Before removing an optical drive, be sure that a disc is not in the drive, and be sure that the optical drive tray is closed.
  - Handle drives on surfaces covered with at least 2.54 cm (1 inch) of shock-proof foam.
  - Avoid dropping drives from any height onto any surface.
  - After removing a hard drive or an optical drive, place it in a static-proof bag.
  - Avoid exposing an internal hard drive to products that have magnetic fields, such as monitors or speakers.
  - Avoid exposing a drive to temperature extremes or liquids.
  - If a drive must be mailed, place the drive in a bubble pack mailer or other suitable form of protective packaging, and label the package "FRAGILE."
- 

## Electrostatic discharge information

A sudden discharge of static electricity from your finger or other conductor can destroy static-sensitive devices or microcircuitry. Often the spark is neither felt nor heard, but damage occurs. An electronic device exposed to electrostatic discharge (ESD) might not appear to be affected at all and can work perfectly throughout a normal cycle. The device might function normally for a while, but it has been degraded in the internal layers, reducing its life expectancy.

Networks built into many integrated circuits provide some protection, but in many cases, the discharge contains enough power to alter device parameters or melt silicon junctions.

---

 **IMPORTANT:** To prevent damage to the device when you remove or install internal components, observe these precautions:

- Keep components in their electrostatic-safe containers until you are ready to install them.
  - Before touching an electronic component, discharge static electricity by using the guidelines described in [Personal grounding methods and equipment on page 26](#).
  - Avoid touching pins, leads, and circuitry. Handle electronic components as little as possible.
  - If you remove a component, place it in an electrostatic-safe container.
- 

## Generating static electricity

Follow these static electricity guidelines:

- Different activities generate different amounts of static electricity.
- Static electricity increases as humidity decreases.

**Table 4-1 Static electricity occurrence based on activity and humidity**

Event	Relative humidity		
	55%	40%	10%
Walking across carpet	7,500 V	15,000 V	35,000 V
Walking across vinyl floor	3,000 V	5,000 V	12,000 V
Motions of bench worker	400 V	800 V	6,000 V
Removing dual in-line packages (DIPs) from plastic tube	400 V	700 V	2,000 V
Removing DIPs from vinyl tray	2,000 V	4,000 V	11,500 V
Removing DIPs from polystyrene foam	3,500 V	5,000 V	14,500 V
Removing bubble pack from PCB (printed circuit board)	7,000 V	20,000 V	26,500 V
Packing PCBs in foam-lined box	5,000 V	11,000 V	21,000 V
Multiple electric components can be packaged together in plastic tubes, trays, or polystyrene foam.			



**NOTE:** As little as 700 V of static electricity can degrade a product.

## Preventing electrostatic damage to equipment

Many electronic components are sensitive to ESD. Circuitry design and structure determine the degree of sensitivity.

The following packaging and grounding precautions are necessary to prevent static electricity damage to electronic components:

- To avoid hand contact, transport products in static-safe containers such as tubes, bags, or boxes.
- Protect all electrostatic parts and assemblies with conductive or approved containers or packaging.
- Keep electrostatic-sensitive parts in their containers until they arrive at static-free stations.
- Place items on a grounded surface before removing them from their container.
- Always be properly grounded when touching a sensitive component or assembly.
- Avoid contact with pins, leads, or circuitry.
- Place reusable electrostatic-sensitive parts from assemblies in protective packaging or conductive foam.

## Personal grounding methods and equipment

Using certain equipment can prevent static electricity damage to electronic components.

- **Wrist straps** are flexible straps with a maximum of 1 M $\Omega$   $\pm$ 10% resistance in the ground cords. To provide proper ground, a strap must be worn snug against bare skin. The ground cord must be connected and fit snugly into the banana plug connector on the grounding mat or workstation.
- You can use **heel straps, toe straps, and boot straps** at standing workstations. These straps are compatible with most types of shoes or boots. On conductive floors or dissipative floor mats, use them on both feet with a maximum of 1 M $\Omega$   $\pm$ 10% resistance between the operator and ground.

**Table 4-2 Static shielding protection levels**

Static shielding protection levels	
Method	Voltage
Antistatic plastic	1,500
Carbon-loaded plastic	7,500
Metallized laminate	15,000

## Grounding the work area

To prevent static damage at the work area, follow these precautions:

- Cover the work surface with approved static-dissipative material.
- Use a wrist strap connected to a properly grounded work surface and use properly grounded tools and equipment.
- Use static-dissipative mats, foot straps, or air ionizers to give added protection.
- Handle electrostatic sensitive components, parts, and assemblies by the case or PCB laminate. Handle them only at static-free work areas.
- Turn off power and input signals before inserting and removing connectors or test equipment.
- Use fixtures made of static-safe materials when fixtures must directly contact dissipative surfaces.
- Keep the work area free of nonconductive materials, such as ordinary plastic assembly aids and polystyrene foam.
- Use conductive field service tools, such as cutters, screwdrivers, and vacuums.
- Avoid contact with pins, leads, or circuitry.

## Recommended materials and equipment

HP recommends certain materials and equipment to prevent static electricity:

- Antistatic tape
- Antistatic smocks, aprons, or sleeve protectors
- Conductive bins and other assembly or soldering aids
- Conductive foam
- Conductive tabletop workstations with ground cord of  $1\text{ M}\Omega \pm 10\%$  resistance
- Static-dissipative table or floor mats with hard tie to ground
- Field service kits
- Static awareness labels
- Wrist straps and footwear straps providing  $1\text{ M}\Omega \pm 10\%$  resistance
- Material handling packages

- Conductive plastic bags
- Conductive plastic tubes
- Conductive tote boxes
- Opaque shielding bags
- Transparent metallized shielding bags
- Transparent shielding tubes

## Cleaning your computer

Cleaning your computer regularly removes dirt and debris so that your device continues to operate at its best. Use the following information to safely clean the external surfaces of your computer.

### Enabling HP Easy Clean (select products only)

HP Easy Clean helps you to avoid accidental input while you clean the computer surfaces. This software disables devices such as the keyboard, touch screen, and touchpad for a preset amount of time so that you can clean all computer surfaces.

1. Start HP Easy Clean in one of the following ways:
  - Select the **Start** menu, and then select **HP Easy Clean**.
  - or -
  - Select the **HP Easy Clean** icon in the taskbar.
  - or -
  - Select **Start**, and then select the **HP Easy Clean** tile.
2. Now that your device is disabled for a short period, see [Removing dirt and debris from your computer on page 28](#) for the recommended steps to clean the high-touch, external surfaces on your computer. After you remove the dirt and debris, you can also clean the surfaces with a disinfectant. See [Cleaning your computer with a disinfectant on page 29](#) for guidelines to help prevent the spread of harmful bacteria and viruses.

### Removing dirt and debris from your computer

Here are the recommended steps to clean dirt and debris from your computer.

For computers with wood veneer, see [Caring for wood veneer \(select products only\) on page 30](#).

1. Wear disposable gloves made of latex (or nitrile gloves, if you are latex-sensitive) when cleaning the surfaces.
2. Turn off your device and unplug the power cord and other connected external devices. Remove any installed batteries from items such as wireless keyboards.

---

 **CAUTION:** To prevent electric shock or damage to components, never clean a product while it is turned on or plugged in.

---

3. Moisten a microfiber cloth with water. The cloth should be moist, but not dripping wet.

---

 **IMPORTANT:** To avoid damaging the surface, avoid abrasive cloths, towels, and paper towels.

---

4. Wipe the exterior of the product gently with the moistened cloth.

---

 **IMPORTANT:** Keep liquids away from the product. Avoid getting moisture in any openings. If liquid makes its way inside your HP product, it can cause damage to the product. Do not spray liquids directly on the product. Do not use aerosol sprays, solvents, abrasives, or cleaners containing hydrogen peroxide or bleach that might damage the finish.

---

5. Start with the display (if applicable). Wipe carefully in one direction, and move from the top of the display to the bottom. Finish with any flexible cables, like power cord, keyboard cable, and USB cables.
6. Be sure that surfaces have completely air-dried before turning the device on after cleaning.
7. Discard the gloves after each cleaning. Clean your hands immediately after you remove the gloves.

See [Cleaning your computer with a disinfectant on page 29](#) for recommended steps to clean the high-touch, external surfaces on your computer to help prevent the spread of harmful bacteria and viruses.

## Cleaning your computer with a disinfectant

The World Health Organization (WHO) recommends cleaning surfaces, followed by disinfection, as a best practice for preventing the spread of viral respiratory illnesses and harmful bacteria.

After cleaning the external surfaces of your computer using the steps in [Removing dirt and debris from your computer on page 28](#), [Caring for wood veneer \(select products only\) on page 30](#), or both, you might also choose to clean the surfaces with a disinfectant. A disinfectant that is within HP's cleaning guidelines is an alcohol solution consisting of 70% isopropyl alcohol and 30% water. This solution is also known as rubbing alcohol and is sold in most stores.

Follow these steps when disinfecting high-touch, external surfaces on your computer:

1. Wear disposable gloves made of latex (or nitrile gloves, if you are latex-sensitive) when cleaning the surfaces.
2. Turn off your device and unplug the power cord and other connected external devices. Remove any installed batteries from items such as wireless keyboards.

---

 **CAUTION:** To prevent electric shock or damage to components, never clean a product while it is turned on or plugged in.

---

3. Moisten a microfiber cloth with a mixture of 70% isopropyl alcohol and 30% water. The cloth should be moist, but not dripping wet.

---

 **CAUTION:** Do not use any of the following chemicals or any solutions that contain them, including spray-based surface cleaners: bleach, peroxides (including hydrogen peroxide), acetone, ammonia, ethyl alcohol, methylene chloride, or any petroleum-based materials, such as gasoline, paint thinner, benzene, or toluene.

---

 **IMPORTANT:** To avoid damaging the surface, avoid abrasive cloths, towels, and paper towels.

---

4. Wipe the exterior of the product gently with the moistened cloth.

---

 **IMPORTANT:** Keep liquids away from the product. Avoid getting moisture in any openings. If liquid makes its way inside your HP product, it can cause damage to the product. Do not spray liquids directly on the product. Do not use aerosol sprays, solvents, abrasives, or cleaners containing hydrogen peroxide or bleach that might damage the finish.

---

5. Start with the display (if applicable). Wipe carefully in one direction, and move from the top of the display to the bottom. Finish with any flexible cables, like power cord, keyboard cable, and USB cables.
6. Be sure that surfaces have completely air-dried before turning the device on after cleaning.
7. Discard the gloves after each cleaning. Clean your hands immediately after you remove the gloves.

## Caring for wood veneer (select products only)

Your product might feature high-quality wood veneer. As with all natural wood products, proper care is important for best results over the life of the product. Because of the nature of natural wood, you might see unique variations in the grain pattern or subtle variations in color, which are normal.

- Clean the wood with a dry, static-free microfiber cloth or chamois.
- Avoid cleaning products containing substances such as ammonia, methylene chloride, acetone, turpentine, or other petroleum-based solvents.
- Do not expose the wood to sun or moisture for long periods of time.
- If the wood becomes wet, dry it by dabbing with an absorbent, lint-free cloth.
- Avoid contact with any substance that might dye or discolor the wood.
- Avoid contact with sharp objects or rough surfaces that might scratch the wood.

See [Removing dirt and debris from your computer on page 28](#) for the recommended steps to clean the high-touch, external surfaces on your computer. After you remove the dirt and debris, you can also clean the surfaces with a disinfectant. See [Cleaning your computer with a disinfectant on page 29](#) for sanitizing guidelines to help prevent the spread of harmful bacteria and viruses.

## Packaging and transporting guidelines

Follow these grounding guidelines when packaging and transporting equipment:

- To avoid hand contact, transport products in static-safe tubes, bags, or boxes.
- Protect ESD-sensitive parts and assemblies with conductive or approved containers or packaging.
- Keep ESD-sensitive parts in their containers until the parts arrive at static-free workstations.
- Place items on a grounded surface before removing items from their containers.
- Always be properly grounded when touching a component or assembly.
- Store reusable ESD-sensitive parts from assemblies in protective packaging or nonconductive foam.

- Use transporters and conveyors made of antistatic belts and roller bushings. Be sure that mechanized equipment used for moving materials is wired to ground and that proper materials are selected to avoid static charging. When grounding is not possible, use an ionizer to dissipate electric charges.

## Accessing support information

To find the HP support that you need, use this information.

**Table 4-3 Support information locations**

Service consideration	Path to access information
Records of reported failure incidents stored on the computer	<p><b>Windows®:</b></p> <p>Preoperating system failures are logged in the BIOS Event Log. To view the BIOS Event Log:</p> <ol style="list-style-type: none"> <li>1. Press the power button.</li> <li>2. Immediately and repeatedly press <b>esc</b> when the power button light turns white.</li> </ol> <p><b>NOTE:</b> If you do not press <b>esc</b> at the appropriate time, you must restart the computer and again repeatedly press <b>esc</b> when the power button light turns white to access the utility.</p> <ol style="list-style-type: none"> <li>3. Press <b>f10</b> to enter the BIOS setup.</li> <li>4. (On commercial products) Under the <b>Main</b> tab, select <b>BIOS event log</b>, and then select <b>View BIOS Event Log</b>.</li> </ol> <p>- or -</p> <p>(On consumer products) Under the <b>Main</b> tab, select <b>System Log</b>.</p> <p>Post-operating system failures are logged in the Event Viewer.</p> <ol style="list-style-type: none"> <li>1. Turn on the computer and allow the operating system to open.</li> <li>2. Select the search icon  in the taskbar.</li> <li>3. Type <code>Event Viewer</code>, and then press <b>enter</b>.</li> <li>4. Select the log from the left panel. Details display in the right panel.</li> </ol> <p><b>Chrome™:</b></p> <ol style="list-style-type: none"> <li>1. Go to <a href="https://support.google.com/chrome">support.google.com/chrome</a>.</li> <li>2. Search <code>collect Chrome device logs</code>.</li> </ol>
Technical bulletins	<p>To locate technical bulletins:</p> <ol style="list-style-type: none"> <li>1. Go to <a href="https://www.hp.com">www.hp.com</a>.</li> <li>2. Place the cursor over <b>Problem solving</b> to display more options.</li> <li>3. Select <b>Support &amp; Troubleshooting</b>.</li> <li>4. Type the serial number, product number, or product name to go to the product support page.</li> <li>5. Select <b>Advisories</b> to view technical bulletins.</li> </ol>

**Table 4-3 Support information locations (continued)**

Service consideration	Path to access information
Repair professionals	To locate repair professionals: <ol style="list-style-type: none"><li data-bbox="679 306 906 333">1. Go to <a href="http://www.hp.com">www.hp.com</a>.</li><li data-bbox="679 359 1337 386">2. Place the cursor over <b>Support resources</b> to display more options.</li><li data-bbox="679 411 1066 438">3. Select <b>Authorized service providers</b>.</li></ol>
Component and diagnosis information, failure detection, and required action	To locate diagnosis information and actions: <ol style="list-style-type: none"><li data-bbox="679 506 1177 533">1. Go to <a href="http://www.hp.com/go/techcenter/pcdiags">http://www.hp.com/go/techcenter/pcdiags</a>.</li><li data-bbox="679 558 911 585">2. Select <b>Get Support</b>.</li><li data-bbox="679 611 1422 653">3. Near the bottom of the window, select <b>Notebook PCs</b>, and then select your location.</li></ol>

# 5 Removal and replacement procedures for Customer Self-Repair parts

This chapter provides removal and replacement procedures for Customer Self-Repair parts.

 **NOTE:** The Customer Self-Repair program is not available in all locations. Installing a part that is not supported by the Customer Self-Repair program can void your warranty. Check your warranty to determine whether Customer Self-Repair is supported in your location.

## Component replacement procedures

To remove and replace computer components, use these procedures.

 **NOTE:** Details about your computer, including model, serial number, product key, and length of warranty, are on the service tag at the bottom of your computer.

 **NOTE:** HP continually improves and changes product parts. For complete and current information about supported parts for your computer, go to <http://partsurfer.hp.com>, select your country or region, and then follow the on-screen instructions.

Make special note of each screw size and location during removal and replacement.

## Preparation for disassembly

To remove and replace computer components, use these procedures:

For initial safety procedures, see [Removal and replacement procedures preliminary requirements on page 24](#).

1. Turn off the computer. If you are unsure whether the computer is off or in Hibernation, turn the computer on, and then shut it down through the operating system.
2. Disconnect the power from the computer by unplugging the power cord from the computer.
3. Disconnect all external devices from the computer.

## Solid-state drive

To remove the solid-state drive, use this procedure and illustration.

**Table 5-1 Solid-state drive descriptions and part numbers**

Description	Spare part number
1 TB, PCIe-4 × 4, TLC	M16560-001
	M16560-005
512 GB, PCIe-4 × 4, TLC	M17436-001
	M17436-005
Thermal pad	N49444-001

Before removing the solid-state drive, follow these steps:

1. Prepare the computer for disassembly (see [Preparation for disassembly on page 33](#)).
2. Remove the bottom cover (see [Bottom cover on page 38](#)).
3. Disconnect the battery cable from the system board (see [Battery on page 40](#)).

Two solid-state drive slots are available on the computer, as shown by callout **(1)** in the following illustration. The primary drive is on the right side of the illustration. Callout **(2)** shows the memory modules.

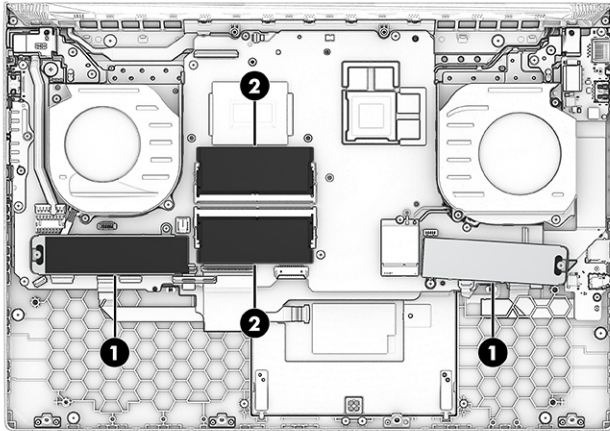

Remove the solid-state drive:

1. Lift the Mylar that covers the top screw **(1)**.
2. Remove the two Phillips M2.0 × 2.5 screws **(2)** that secure the bracket and drive to the computer.
3. Pull the drive out of the socket, and remove the drive with bracket from the computer **(3)**.

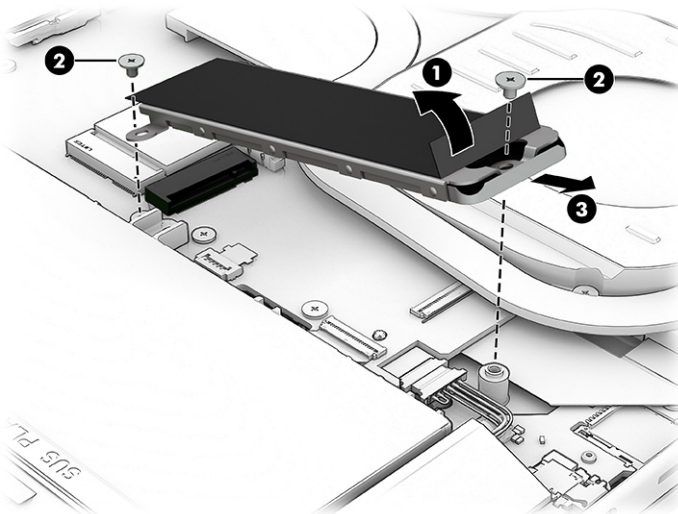

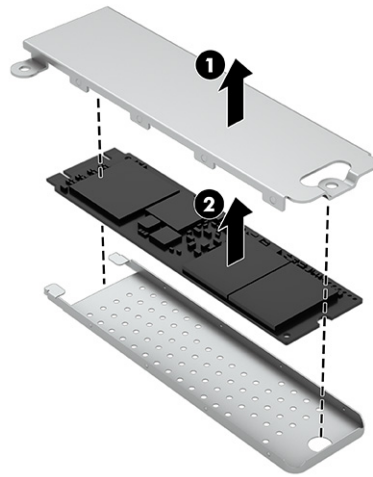

4. To separate the drive from the bracket, while holding the bottom bracket, pull the top bracket up (1) to release it. Remove the drive from the bottom bracket (2).

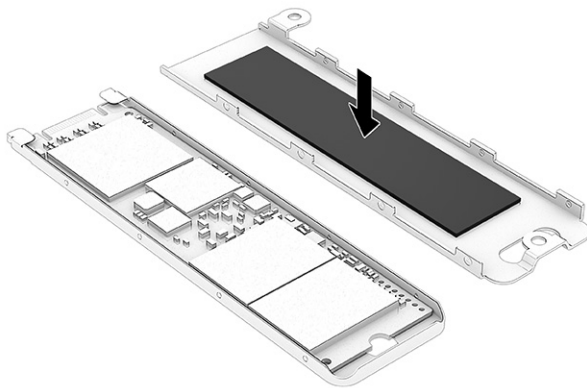

To install the solid-state drive, reverse the removal procedures.

When installing a solid-state drive, be sure the thermal pad is installed on the inside of the top bracket



 **NOTE:** Solid-state drives are designed with a notch to prevent incorrect insertion.

## Memory modules

To remove the memory modules, use this procedure and illustration.

**Table 5-2** Memory module descriptions and part numbers

Description	Spare part number
Memory module, 16 GB (DDR5-5600)	N38627-005
Memory module, 8 GB (DDR5-5600)	N37792-005

Before removing the memory, follow these steps:

1. Prepare the computer for disassembly (see [Preparation for disassembly on page 33](#)).

2. Remove the bottom cover (see [Bottom cover on page 38](#)).
3. Disconnect the battery cable from the system board (see [Battery on page 40](#)).

If you are replacing a memory module, remove the existing memory module:

- Spread the two retention clips outward **(1)** until the memory module tilts up at a 45° angle, and then remove the module **(2)**. Use the same procedure to remove all memory modules.

---

 **IMPORTANT:** To prevent damage to the memory module, hold the memory module by the edges only. Do not touch the components on the memory module.

---

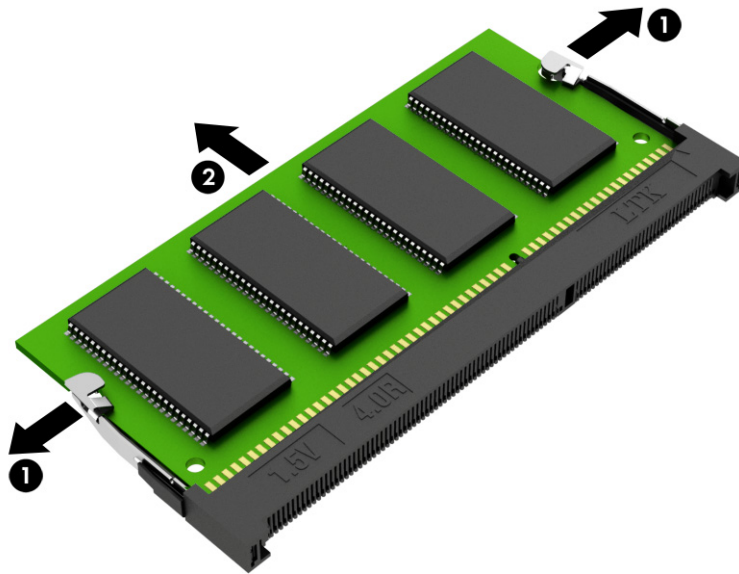

To protect a memory module after removal, place it in an electrostatic-safe container.

To install a memory module:

1. Align the notched edge of the module with the tab in the slot **(1)**, and then press the module into the slot at an angle until it is seated **(2)**.

2. Press down on the module until the side retention clips snap into place (3).

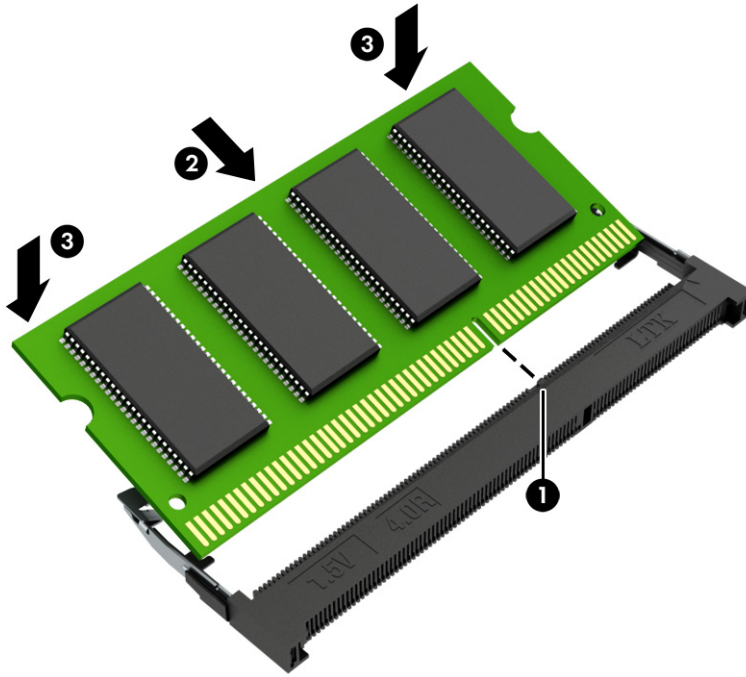

---

# 6 Removal and replacement procedures for authorized service provider parts

This chapter provides removal and replacement procedures for authorized service provider parts.

 **IMPORTANT:** Only an authorized service provider should access the components described in this chapter. Accessing these parts can damage the computer or void the warranty.

 **NOTE:** Details about your computer, including model, serial number, product key, and length of warranty, are on the service tag at the bottom of your computer.

---

## Component replacement procedures

To remove and replace computer components, use the procedures described in this section.

 **NOTE:** HP continually improves and changes product parts. For complete and current information about supported parts for your computer, go to <http://partsurfer.hp.com>, select your country or region, and then follow the on-screen instructions.

---

Make special note of each screw size and location during removal and replacement.

## Preparation for disassembly

To remove and replace computer components, use these procedures:

For initial safety procedures, see [Removal and replacement procedures preliminary requirements on page 24](#).

1. Turn off the computer. If you are unsure whether the computer is off or in Hibernation, turn the computer on, and then shut it down through the operating system.
2. Disconnect the power from the computer by unplugging the power cord from the computer.
3. Disconnect all external devices from the computer.

## Bottom cover

To remove the bottom cover, use this procedure and illustration.

**Table 6-1 Bottom cover descriptions and part numbers**

Description	Spare part number
Ceramic white, 80 W	N42542-001
Mica silver, 80 W	N42544-001
Performance blue, 80 W	N42543-001
Ceramic white, 60 W	N57417-001
Mica silver, 60 W	N57418-001

**Table 6-1 Bottom cover descriptions and part numbers (continued)**

Description	Spare part number
Performance blue, 60 W	N57419-001

Before removing the bottom cover, prepare the computer for disassembly (see [Preparation for disassembly on page 33](#)).

Remove the bottom cover:

1. Remove the two Phillips M2.5 × 12.0 screws (1) and six Phillips M2.0 × 4.0 screws (2) that secure the bottom cover to the computer.

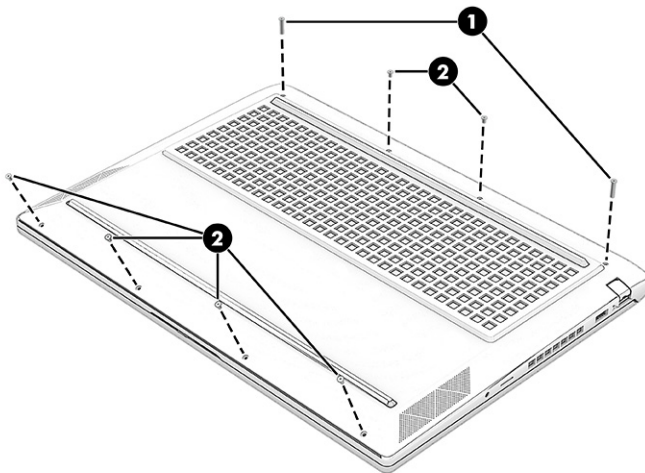

2. Lift the edge of the cover up from the top of the computer to release it (1), and then remove the bottom cover from the computer (2).

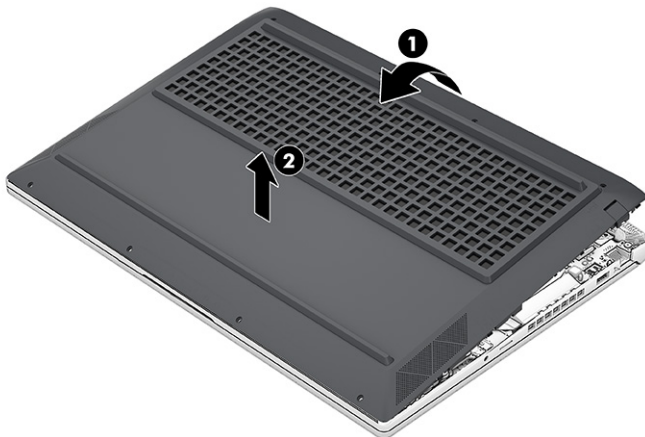

To replace the bottom cover, reverse the removal procedures.

## RJ-45 door

To remove the RJ-45 door, use this procedure and illustration.

**Table 6-2 RJ-45 door description and part number**

Description	Spare part number
RJ-45 door, ceramic white	N49440-001
RJ-45 door, mica silver	N49441-001
RJ-45 door, performance blue	N49442-001

Before removing the RJ-45 door, follow these steps:

1. Prepare the computer for disassembly (see [Preparation for disassembly on page 33](#)).
2. Remove the bottom cover (see [Bottom cover on page 38](#)).

Remove the RJ-45 door:

1. Remove the two Phillips M2.0 × 2.5 screws (1), and then remove the bracket (2).
2. Lift the inside of the door up (3), and then lift the door up to remove it from the bottom cover (4).

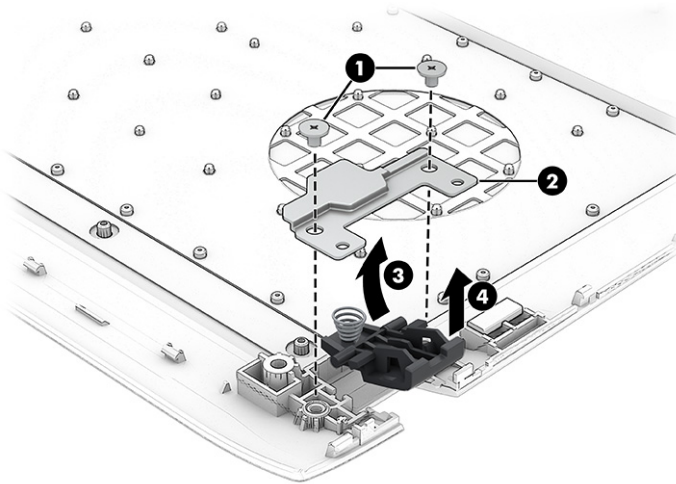

To install the RJ-45 door, reverse the removal procedure.

## Battery

To remove the battery, use this procedure and illustration.

**Table 6-3 Battery description and part number**

Description	Spare part number
6 cell, 83 Whr	M41711-005

**Table 6-3 Battery description and part number (continued)**

Description	Spare part number
4 cell, 70 Whr	M39179-005

 **WARNING!** To avoid personal injury and damage to the product:

- Do *not* puncture, twist, or crack the battery.
- Do *not* cause an external puncture or rupture to the battery. They can cause a short inside the battery, which can result in battery thermal runaway.
- Do *not* handle or touch the battery enclosure with sharp objects such as tweezers or pliers, which might puncture the battery.
- Do *not* compress or squeeze the battery case with tools or heavy objects stacked on top of the case. These actions can apply undue force on the battery.
- Do *not* touch the connectors with any metallic surface or object, such as metal tools, screws, or coins, which can cause shorting across the connectors.

Before removing the battery, follow these steps:

1. Prepare the computer for disassembly (see [Preparation for disassembly on page 33](#)).
2. Remove the bottom cover (see [Bottom cover on page 38](#)).

 **WARNING!** To reduce potential safety issues, use only the user-replaceable battery provided with the computer, a replacement battery provided by HP, or a compatible battery purchased from HP.

 **IMPORTANT:** Removing a battery that is the sole power source for the computer can cause loss of information. To prevent loss of information, save your work or shut down the computer through Windows before you remove the battery.

Remove the battery:

1. Disconnect the battery cable from the system board **(1)**.
2. Remove the six Phillips M2.0 × 5.0 screws **(2)** that secure the battery to the computer.

3. Remove the battery from the computer (3).

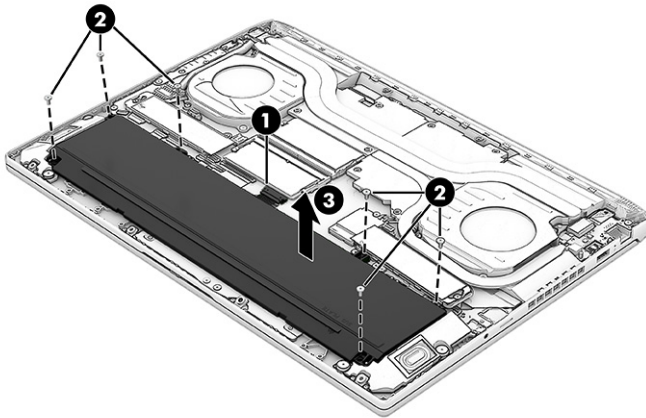

To replace the battery, reverse the removal procedures.

## WLAN module

To remove the WLAN module, use this procedure and illustration.

**Table 6-4 WLAN module descriptions and part numbers**

Description	Spare part number
MediaTek MT7921 Wi-Fi® 6 Bluetooth® 5.3 WW WLAN	M74879-005
Intel AX211 Wi-Fi 6E Bluetooth 5.3 WLAN	M53366-005

**IMPORTANT:** To prevent an unresponsive system, replace the wireless module only with a wireless module authorized for use in the computer by the governmental agency that regulates wireless devices in your country or region. If you replace the module and then receive a warning message, remove the module to restore device functionality, and then contact technical support.

Before removing the WLAN module, follow these steps:

1. Prepare the computer for disassembly (see [Preparation for disassembly on page 33](#)).
2. Remove the bottom cover (see [Bottom cover on page 38](#)).
3. Remove the battery (see [Battery on page 40](#)).

Remove the WLAN module:

1. Remove the plastic antenna protector from the module (1).
2. Carefully disconnect the antenna cables from the module (2).
3. Remove the Phillips M2.0 × 2.5 screw (3), and then remove the WLAN module from the computer (4).

**NOTE:** The #1 white WLAN antenna cable connects to the WLAN module Main terminal. The #2 black WLAN antenna cable connects to the WLAN module Aux terminal.

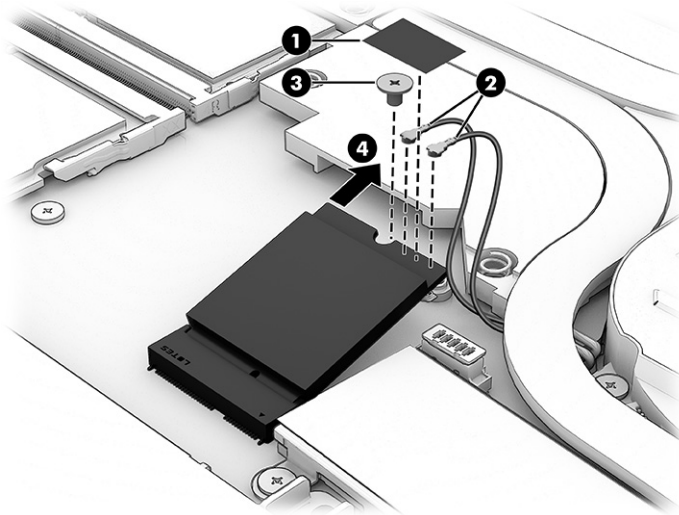

4. If the WLAN antenna is not connected to the terminal on the WLAN module, you must install a protective sleeve on the antenna connector, as shown in the following illustration.

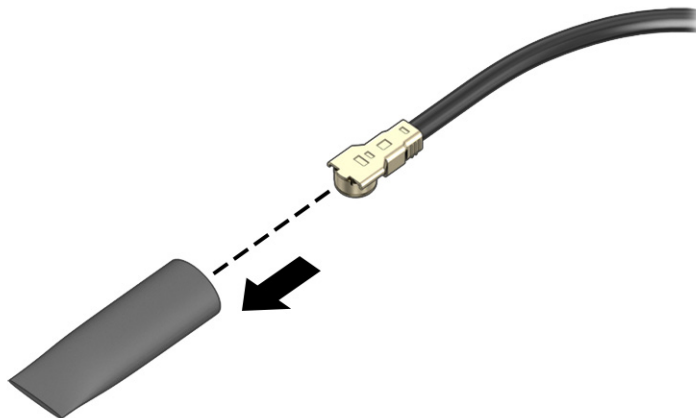

To install the WLAN module, reverse the removal procedure.

## Speakers

To remove the speakers, use this procedure and illustration.

**Table 6-5** Speaker description and part number

Description	Spare part number
Speakers	N49443-001

Before removing the speakers, follow these steps:

1. Prepare the computer for disassembly (see [Preparation for disassembly on page 33](#)).

2. Remove the bottom cover (see [Bottom cover on page 38](#)).
3. Remove the battery (see [Battery on page 40](#)).

Remove the speakers:

1. Disconnect the speaker cable from the system board (1).
2. Remove the two Phillips M2.0 × 4.0 screws from each speaker (2).
3. Remove the cable the routes between the speakers from the tape that secures it to the computer (3).
4. Remove the speakers from the computer (4).

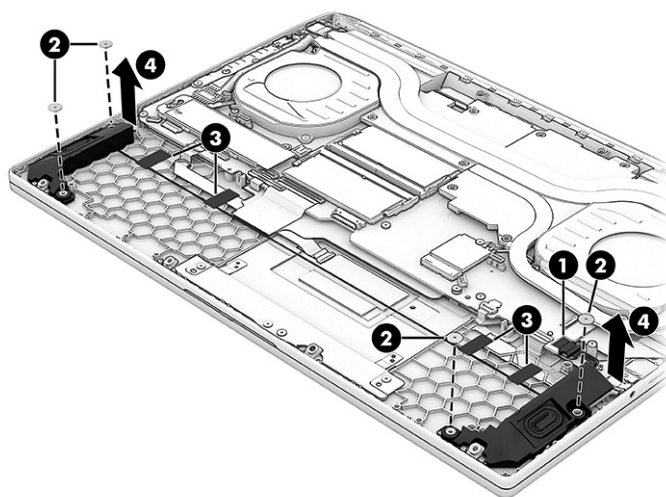

To install the speakers, reverse the removal procedure.

## Touchpad

To remove the touchpad, use this procedure and illustration.

**Table 6-6 Touchpad description and part number**

Description	Spare part number
Touchpad, mica silver	N42559-001
Touchpad, performance blue	N42558-001
Touchpad, ceramic white	N42557-001
Touchpad cable	N42556-001

Before removing the touchpad, follow these steps:

1. Prepare the computer for disassembly (see [Preparation for disassembly on page 33](#)).
2. Remove the bottom cover (see [Bottom cover on page 38](#)).
3. Remove the battery (see [Battery on page 40](#)).

Remove the touchpad:

1. Lift the foil (1) that covers the two outer screws.
2. Remove the four Phillips M2.0 × 2.5 screws (2).
3. Lift the grounding tape (3) that secures the bracket to the computer.
4. Remove the bracket from the computer (4).

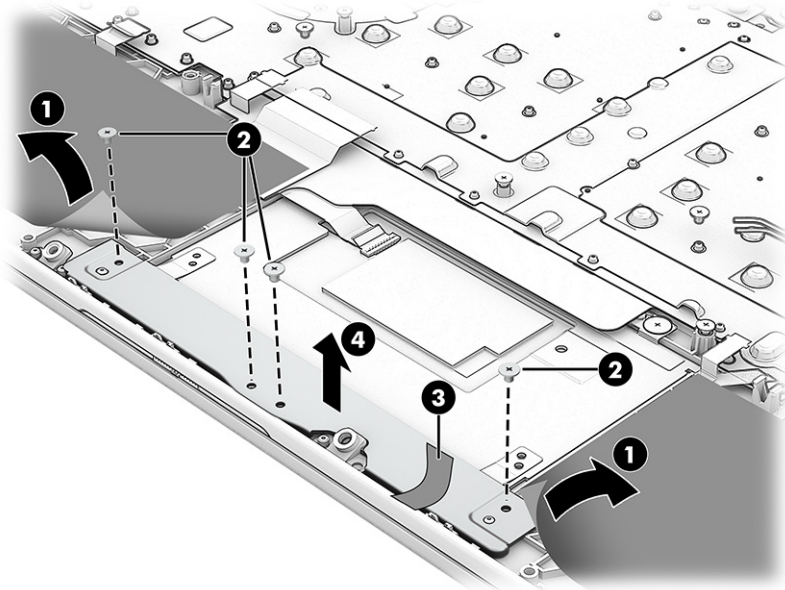

5. Disconnect the touchpad cable from the ZIF connector (1) on the touchpad.
6. Lift the shielding (2) from the top of the touchpad.
7. Remove the three broad head Phillips M2.0 × 2.0 screws (3) from the touchpad.
8. Remove the touchpad from the computer (4).

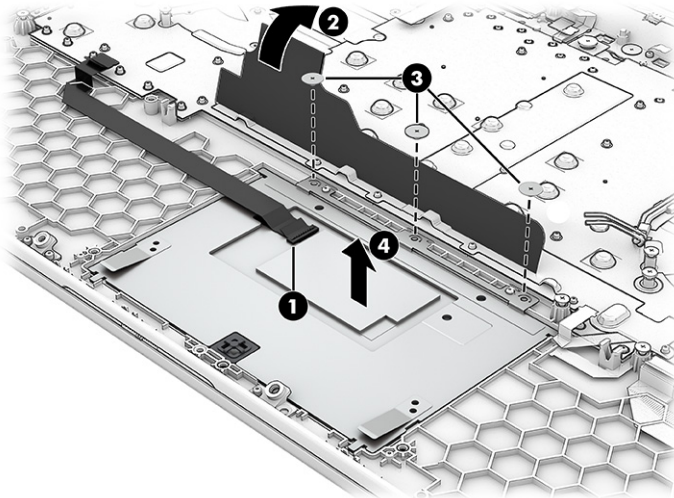

To install the touchpad, use the following procedure:

1. Insert three equally sized folded pieces of paper (1) into the left, right, and bottom sides of the touchpad cavity.
2. Install the touchpad by inserting the bottom of the touchpad into the slot in the computer (2) until the tabs are flush up against the slots.
3. Install the three screws (3).
4. Pull out the three pieces of paper (4).

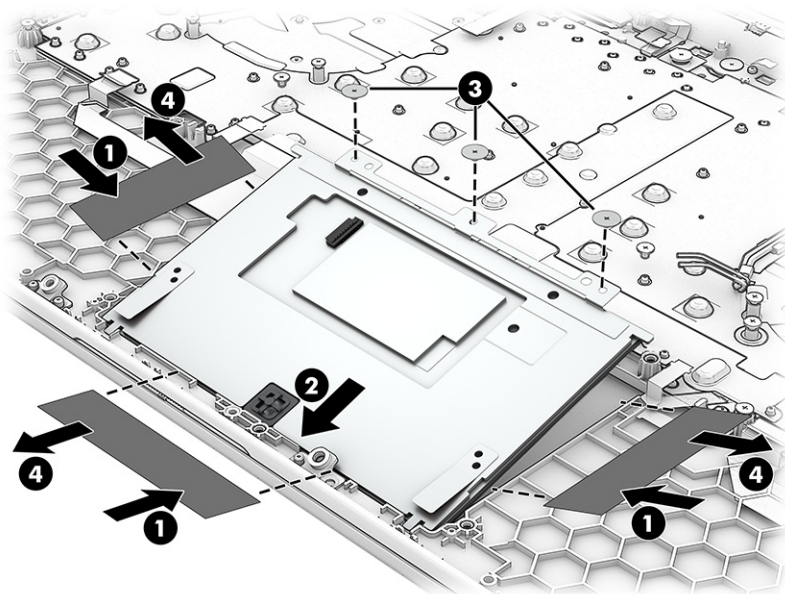

5. Replace the bottom bracket and four screws.
6. Connect the cable to the touchpad.

## Audio board

To remove the audio board, use this procedure and illustration.

**Table 6-7** Audio board description and part number

Description	Spare part number
Audio board	N42552-001
Audio cable	N42553-001

Before removing the audio board, follow these steps:

1. Prepare the computer for disassembly (see [Preparation for disassembly on page 33](#)).
2. Remove the bottom cover (see [Bottom cover on page 38](#)).
3. Remove the battery (see [Battery on page 40](#)).
4. Remove the left speaker (see [Speakers on page 43](#)).
5. Remove the left solid-state drive (see [Solid-state drive on page 33](#)).

Remove the audio board:

1. Remove the two Phillips M2.0 × 3.5 screws (1) that secure the board to the computer.
2. Lift the board up and turn it over to access the cable connection underneath (2).
3. On the bottom of the board, peel the Mylar off the connector (3), and then disconnect the cable from the board (4).

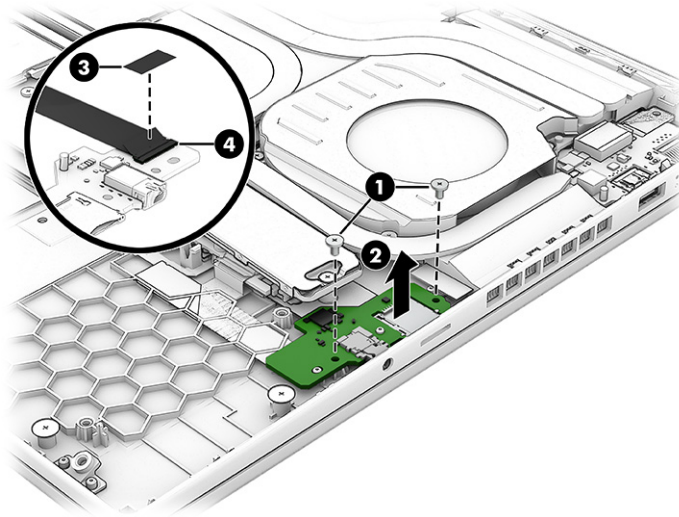

To install the audio board, reverse this procedure.

## Heat sink

To remove the heat sink, use this procedure and illustration.

**Table 6-8** Heat sink descriptions and part numbers

Description	Spare part number
Heat sink, 80 W, HX processors	N42561-001
Heat sink, 80 W, H processors	N42560-001
Heat sink, 60 W, HX processors	N42563-001
Heat sink, 60 W, H processors	N42562-001

Before removing the heat sink, follow these steps:

1. Prepare the computer for disassembly (see [Preparation for disassembly on page 33](#)).
2. Remove the bottom cover (see [Bottom cover on page 38](#)).
3. Disconnect the battery cable from the system board (see [Battery on page 40](#)).

Remove the heat sink:

1. In the order of the screws labeled from '7' to '1' on the heat sink, loosen the seven captive Phillips screws (1) that secure the heat sink to the system board.

- Remove the heat sink (2).

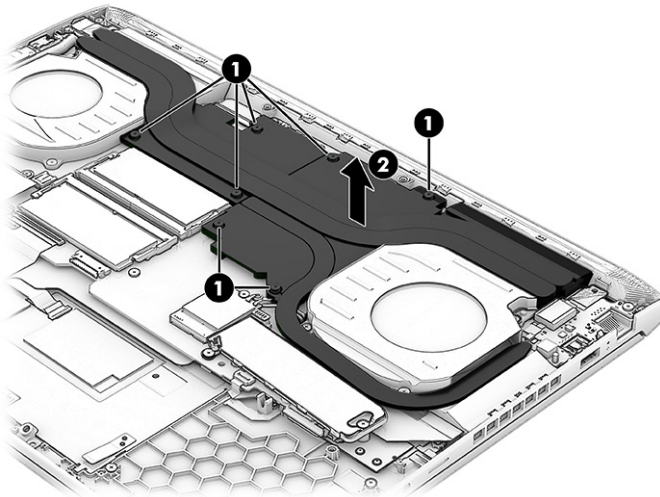

- Use the following illustration to determine replacement thermal material locations. Gray thermal grease (1) and white thermal grease (2) is used on the bottom of heat sink.

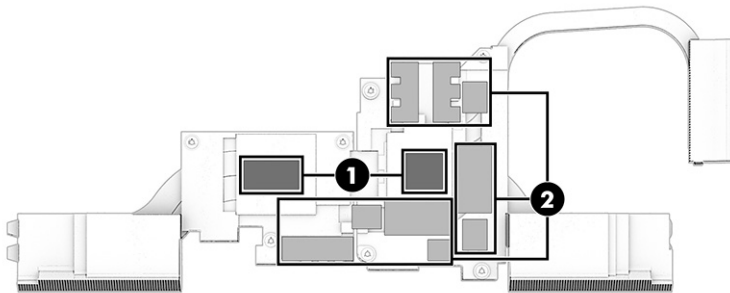

To install the heat sink, reverse the removal procedure.

When installing the heat sink, tighten the screws in the order from '1' to '7'.

## System board with heat sink

To remove the system board with heat sink, use these procedures and illustrations.

**Table 6-9 System board descriptions and part numbers**

Description	Spare part number
<b>System board</b> (includes processor):	
All system boards use the following part numbers:	
xxxxxx-001: Non-Windows operating system	
xxxxxx-601: Windows 10 operating system	
Intel Core i7-13700HX processor and NVIDIA GeForce RTX 4070 graphics	N42529-xx1
Intel Core i7-13700HX processor and NVIDIA GeForce RTX 4060 graphics	N42527-xx1
Intel Core i7-13700HX processor and NVIDIA GeForce RTX 4050 graphics	N42525-xx1

**Table 6-9 System board descriptions and part numbers (continued)**

Description	Spare part number
Intel Core i7-13700HX processor and NVIDIA GeForce RTX 3050 graphics	N42523-001
Intel Core i5-13500HX processor and NVIDIA GeForce RTX 4070 graphics	N42528-xx1
Intel Core i5-13500HX processor and NVIDIA GeForce RTX 4060 graphics	N42526-xx1
Intel Core i5-13500HX processor and NVIDIA GeForce RTX 4050 graphics	N42524-xx1
Intel Core i5-13500HX processor and NVIDIA GeForce RTX 3050 graphics	N42522-xx1
Intel Core i7-13700H processor and NVIDIA GeForce RTX 4070 graphics	N42521-xx1
Intel Core i7-13700H processor and NVIDIA GeForce RTX 4060 graphics	N42520-xx1
Intel Core i7-13700H processor and NVIDIA GeForce RTX 4050 graphics	N42518-xx1
Intel Core i7-13700H processor and NVIDIA GeForce RTX 3050 graphics	N42516-xx1
Intel Core i5-13500H processor and NVIDIA GeForce RTX 4060 graphics	N42519-xx1
Intel Core i5-13500H processor and NVIDIA GeForce RTX 4050 graphics	N42517-xx1
Intel Core i5-13500H processor and NVIDIA GeForce RTX 3050 graphics	N42515-xx1



**NOTE:** You do not have to remove the heat sink to remove the system board.

Before removing the system board, follow these steps:

1. Prepare the computer for disassembly (see [Preparation for disassembly on page 33](#)).
2. Remove the bottom cover (see [Bottom cover on page 38](#)).
3. Remove the battery (see [Battery on page 40](#)).

When you replace the system board, be sure to remove the following components (as applicable) from the defective system board and install them on the replacement system board:

- Memory modules (see [Memory modules on page 35](#)).
- Solid-state drive (see [Solid-state drive on page 33](#)).
- WLAN module (see [WLAN module on page 42](#)).

Remove the system board:

1. Disconnect the following cables from the system board:
  - Display cable (ZIF) **(1)**
  - IR board (ZIF) **(2)**
  - USB board cable (ZIF) **(3)**
  - Speaker cable **(4)**
  - Audio board cable (ZIF) **(5)**
  - Keyboard backlight cable (ZIF) **(6)** (select products only)

- Left fan (7)
- WLAN antennas from the WLAN module (8)
- Keyboard cable (ZIF) (9)
- Touchpad cable (ZIF) (10)
- Right fan (11)
- Power connector (DC-in) board cable (12)

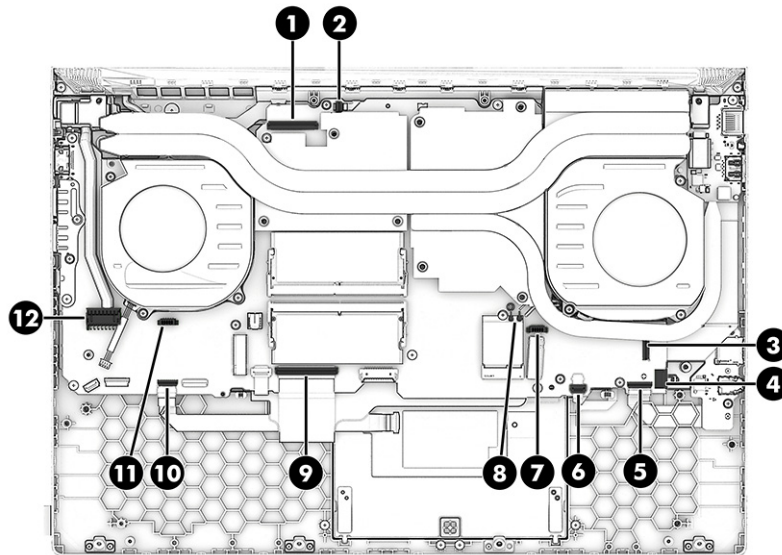

2. Remove the 11 Phillips M2.0 × 2.5 screws (1) that secure the system board to the computer.
3. Remove the USB connector bracket from the system board (2).

- Lift the right side of system board (3), and then pull the system board right and away from the connectors to remove it from the computer (4).

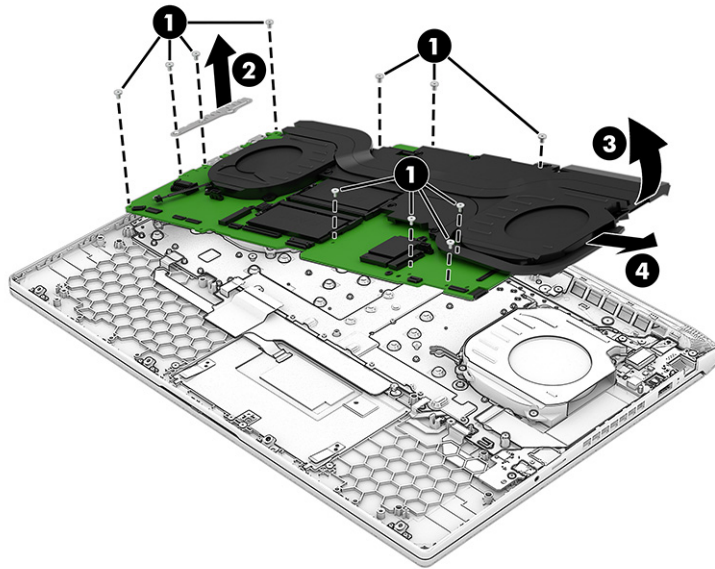

To install the system board, reverse the removal procedure.

## Fans

To remove the fans, use this procedure and illustration.

**Table 6-10 Fans description and part number**

Description	Spare part number
Fan kit, 80 W (includes processor fan and graphics fan)	N44738-001
Fan kit, 60 W (includes processor fan and graphics fan)	N44742-001

Before removing the fans, follow these steps:

- Prepare the computer for disassembly (see [Preparation for disassembly on page 33](#)).
- Remove the bottom cover (see [Bottom cover on page 38](#)).
- Remove the battery (see [Battery on page 40](#)).
- Remove the system board (see [System board with heat sink on page 48](#)).

Remove the fans:

- Remove the three Phillips M2.0 × 3.5 screws (1) that secure each fan to the computer.

2. Remove the fans from the computer (2).

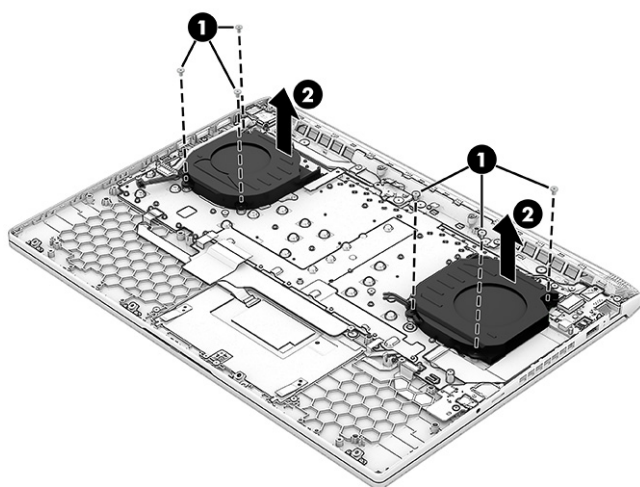

To install the fans, reverse the removal procedure.

## USB/network board

To remove the USB/network board, use this procedure and illustration.

**Table 6-11** USB/network board description and part number

Description	Spare part number
USB/network board	N42550-001
USB/network board cable	N42555-001

Before removing the USB/network board, follow these steps:

1. Prepare the computer for disassembly (see [Preparation for disassembly on page 33](#)).
2. Remove the bottom cover (see [Bottom cover on page 38](#)).
3. Remove the battery (see [Battery on page 40](#)).
4. Remove the system board (see [System board with heat sink on page 48](#)).
5. Remove the left fan (see [Fans on page 51](#)).

Remove the USB/network board:

1. Remove the Phillips M2.0 × 3.5 screw that secures the board to the computer.

2. Lift the board and cable up **(2)**, and then peel the cable off the computer **(3)**. The cable is secured with adhesive.

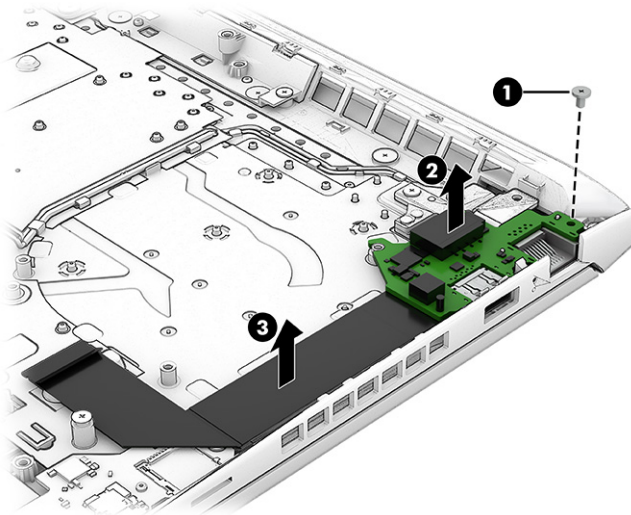

To install the USB/network board, reverse the removal procedure.

## IR board

To remove the IR board, use this procedure and illustration.

**Table 6-12** IR board description and part number

Description	Spare part number
IR board	N42551-001
IR board cable	N42554-001

Before removing the IR board, follow these steps:

1. Prepare the computer for disassembly (see [Preparation for disassembly on page 33](#)).
2. Remove the bottom cover (see [Bottom cover on page 38](#)).
3. Remove the battery (see [Battery on page 40](#)).
4. Remove the system board (see [System board with heat sink on page 48](#)).

Remove the IR board:

1. Remove the Phillips M2.0 × 3.5 screw **(1)** that secures the board to the computer.

2. Remove the board from the computer (2).

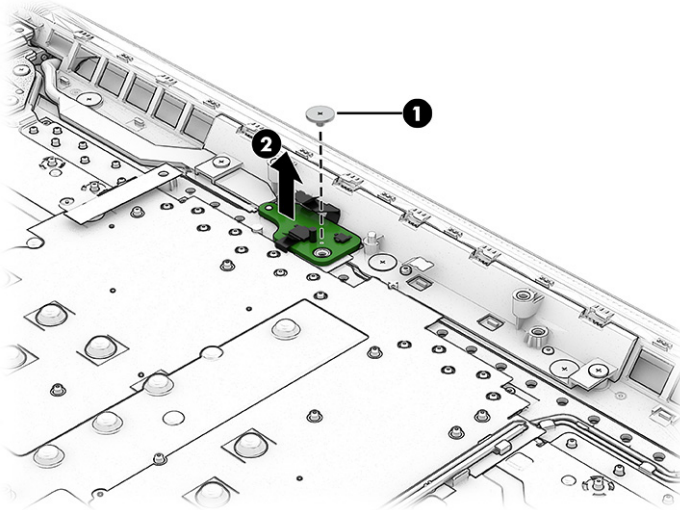

To install the IR board, reverse the removal procedure.

## Display assembly

To remove and disassemble the display assembly, use these procedures and illustrations.

---

 **NOTE:** The display assembly is available as a spare part only at the subcomponent level. For display assembly spare part information, see the individual removal subsections.

---

Before removing the display assembly, follow these steps:

1. Prepare the computer for disassembly (see [Preparation for disassembly on page 33](#)).
2. Remove the bottom cover (see [Bottom cover on page 38](#)).
3. Disconnect the battery cable from the system board (see [Battery on page 40](#)).

---

 **NOTE:** You can remove the bezel and display panel immediately after disconnecting the battery, without removing the entire display assembly from the computer.

---

4. Remove the system board (see [System board with heat sink on page 48](#)).
5. Remove the left fan (see [Fans on page 51](#)).
6. Remove the USB/network board (see [USB/network board on page 52](#)).

Remove the display assembly:

1. You can remove the bezel with the display assembly connected to the computer. To remove the bezel:
  - a. Open the computer to 90° and position the display assembly on a flat surface.
  - b. Use your finger to release the bottom edge of the bezel (1) from the display assembly.
  - c. **From the outside of the bezel**, release the left and right edges of the bezel (2) from the display assembly.

- d. From the outside of the bezel, release the top edge of the bezel (3) from the display assembly.
- e. Remove the display bezel (4) from the display assembly.

 **IMPORTANT:** To avoid damaging the panel, **do not use a tool** to release the inside of the bezel. You can use a tool only when you insert it from the outside of the top, left, and right sides of the bezel. Use your fingers to lift up on the bezel. Avoid pressing down on the panel during removal.

Display adhesive is available in the Adhesive Kit as spare part number N49445-001.

The bezel is available as spare part number N42541-001.

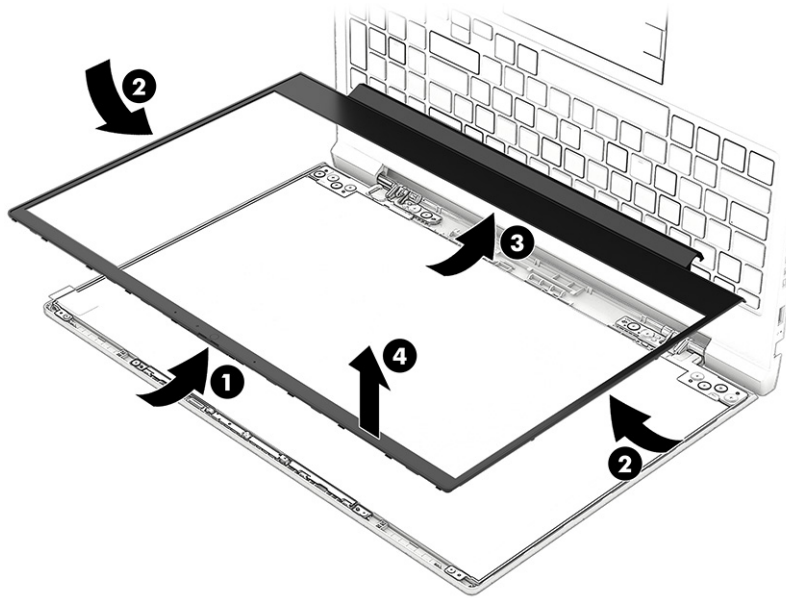

2. You can remove the display panel with the display assembly connected to the computer. To remove the display panel:
  - a. The display panel is secured to the display enclosure with tape that is installed under the left and right sides of the panel. To remove the panel, use tweezers to grasp the end of the tape (1). While turning the tweezers, wrap the tape around the tweezers (2) as you continue to pull the tape out from behind the display panel (3). You must pull the tape multiple times before it is completely removed.

 **NOTE:** Pull the tape out slowly and evenly to prevent it from breaking prematurely.

- b. Rotate the display panel over and place it next to the display enclosure (4).

Display panels are available as the following spare part numbers:

N42534-001: QHD, 300 nits, 144 Hz

N55501-001: QHD, 300 nits, 165 Hz

N42533-001: FHD, 300 nits, low blue light (LBL), Dynamic Display Switch (DDS), 165 Hz

N42532-001: FHD, 300 nits, LBL, 144 Hz

N42531-001: FHD, 300 nits

N42530-001: FHD, 250 nits

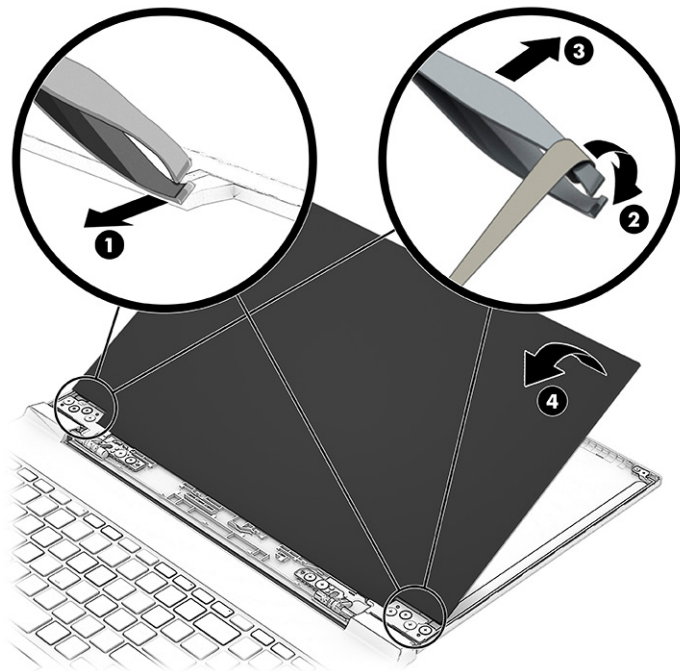

- c. Release the adhesive support strip (1) that secures the display panel cable connector to the display panel.
- d. Lift the locking arm on the cable connector (2).
- e. Disconnect the display panel cable (3) from the display panel.

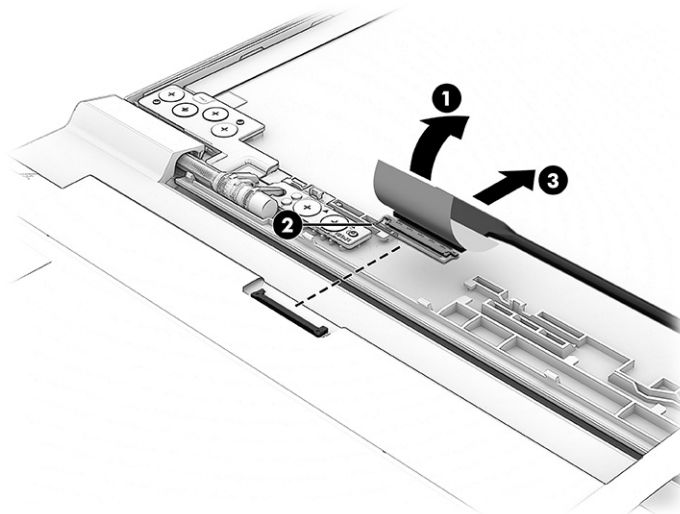

- f. When installing a display panel, install stretchable tape on the left and right sides of the inside of the display rear cover.

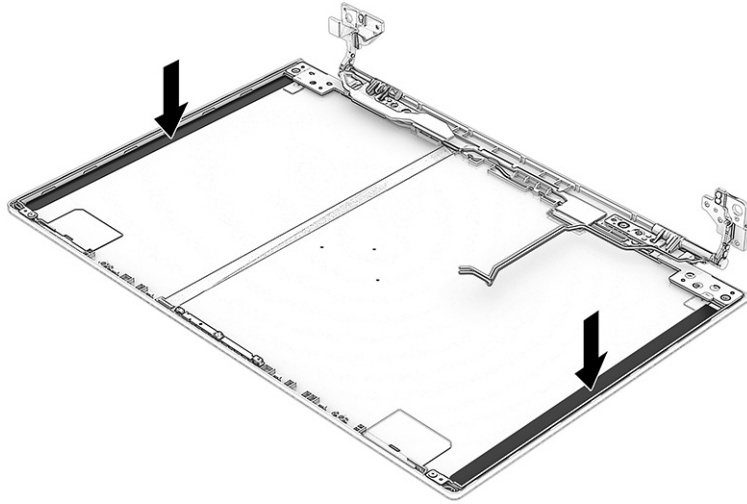

3. To remove the rear bracket:

- a. Lift three pieces of Electromagnetic Interference (EMI) tape that secure the bracket (1).
- b. Remove two Phillips M2.0× 2.5 screws (2) and two broad head Phillips M2.0 × 2.0 screws (3) that secure the bracket to the computer.
- c. Remove the bracket (4).

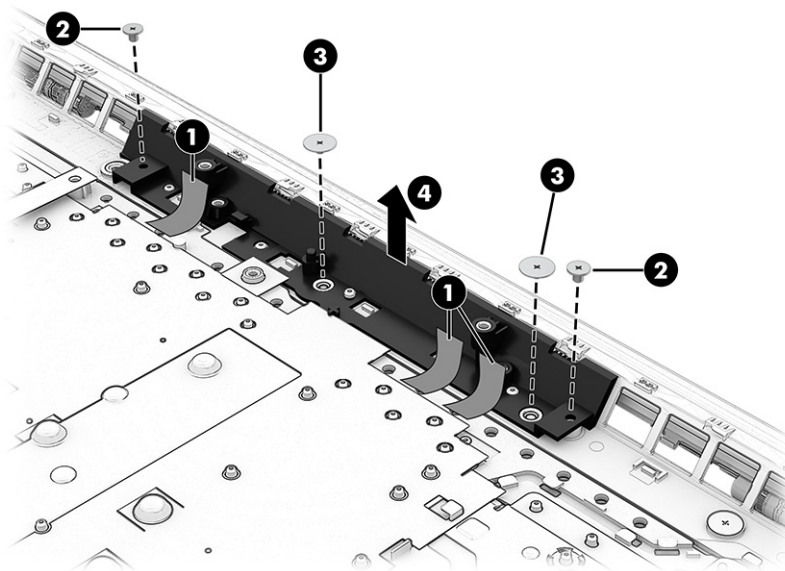

4. To remove the rear vent:

- a. Remove two Phillips M2.0× 2.5 screws (1) and two broad head Phillips M2.0 × 2.0 screws (2) that secure the vent to the computer.

- b. Pry along the bottom of the vent to release it (3).

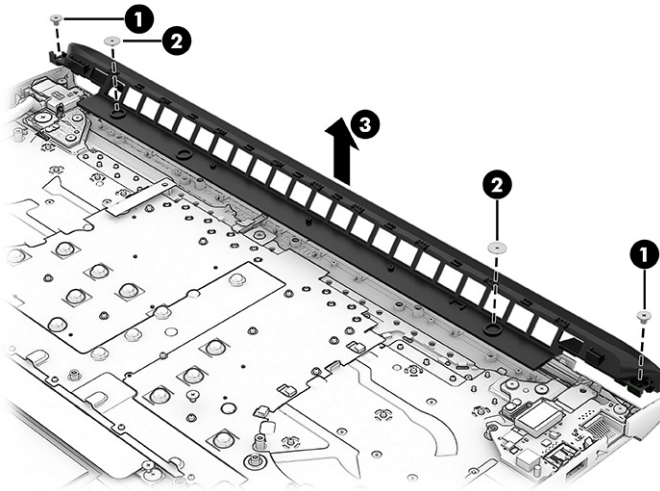

- 5. The remaining display components require that you remove the display assembly from the computer. To remove the display assembly:
  - a. Remove the antenna cables from the tape and clips that secure it to the computer.

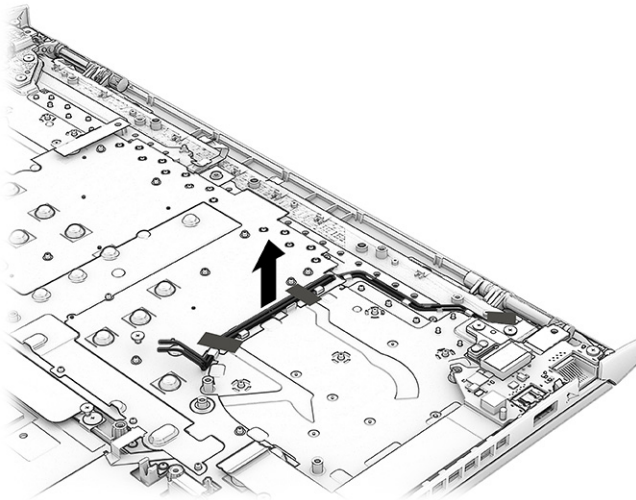

- b. Remove the antenna cable from the channel (1), and the clip (2) in the left hinge.

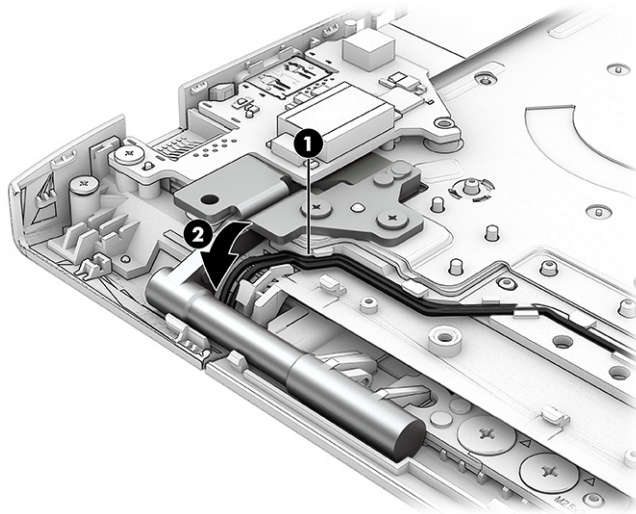

- c. Open the display 90° to open the hinges (1).
- d. Remove the four Phillips M2.5 × 4.5 screws (2) and the two broad head Phillips M2.0 × 2.5 screws (3) that secure the display assembly to the computer.
- e. Separate the display from the computer (4).

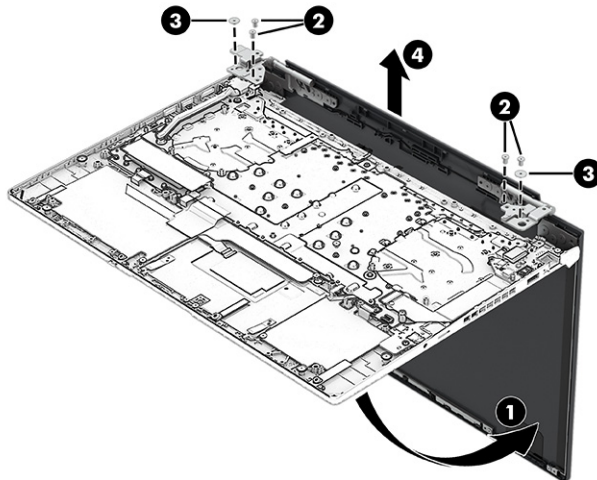

6. To remove the camera module:

- a. Remove the two Phillips M2.0 × 2.0 screws **(1)** that secure the camera bracket, and then remove the bracket **(2)**.

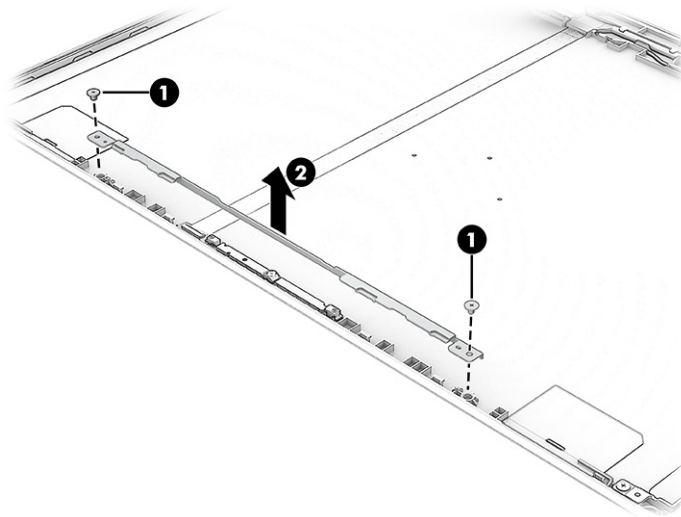

- b. Insert a tool **(1)** under the module, and then pull the tool across the length of the module **(2)** to release it from the display back cover. The module is attached with double-sided adhesive.
- c. Turn the module upside down so you can access the connector.
- d. Disconnect the cable from the module **(3)**. Note that the cable routes under the module. The camera module is available as spare part number N42549-001.

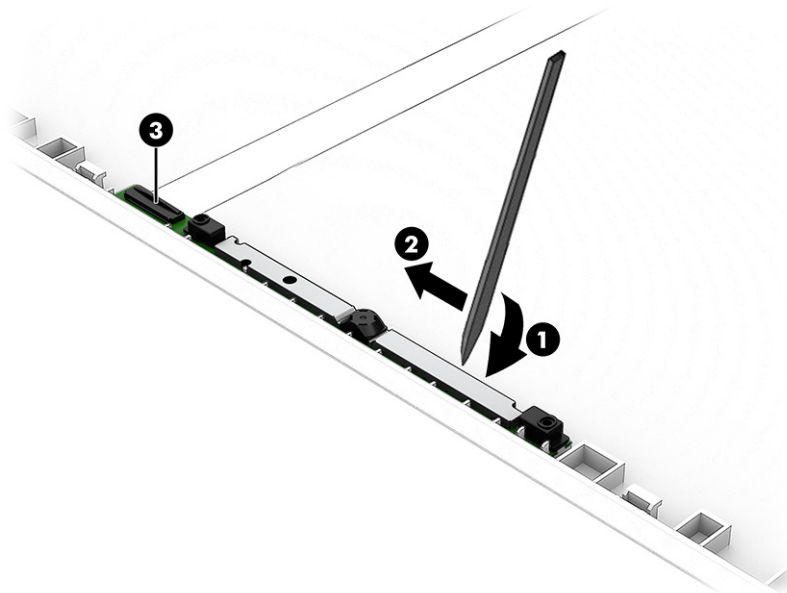

7. To remove the hinges from the display rear cover:
  - a. Remove the six broad head Phillips M2.0 × 2.0 screws **(1)** from each hinge.
  - b. Remove the display cable from the right hinge **(2)**, and remove the antenna cables from the left hinge **(3)**.
  - c. Remove the hinges from the display back cover **(4)**.

The display hinges are available as spare part number N42548-001.

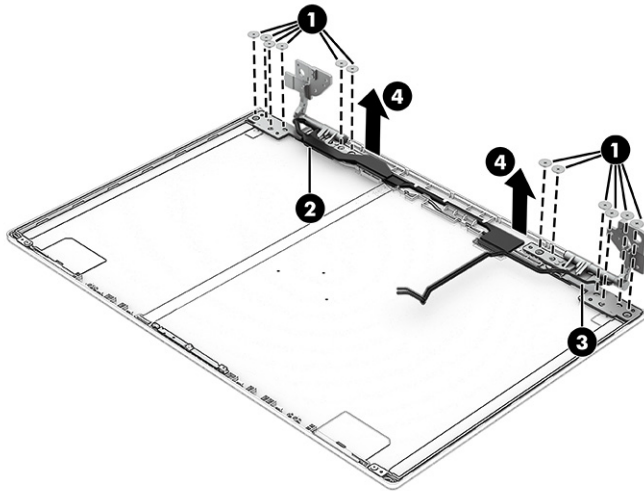

8. Remove the Phillips M2.0 × 2.0 screw (1) that secures the each side bracket, and then remove the brackets (2).

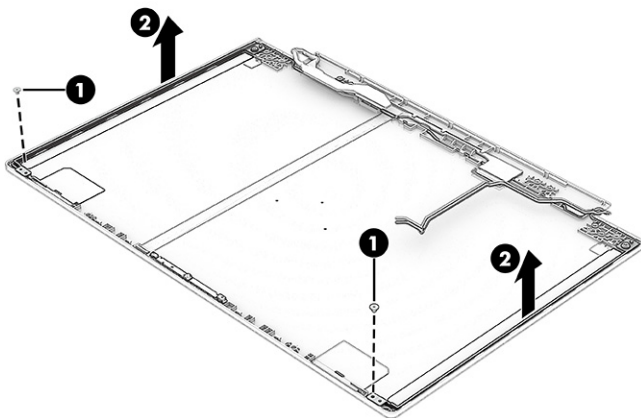

9. To remove the display/camera cable, remove the cable from the routing along the bottom of the display rear cover (1), and then peel the cable off the inside of the cover (2).

Display panel cables are available as the following spare part numbers:

N42546-001: FHD, display panels

N42547-001: FHD, LBL display panels

N42545-001: QHD display panels

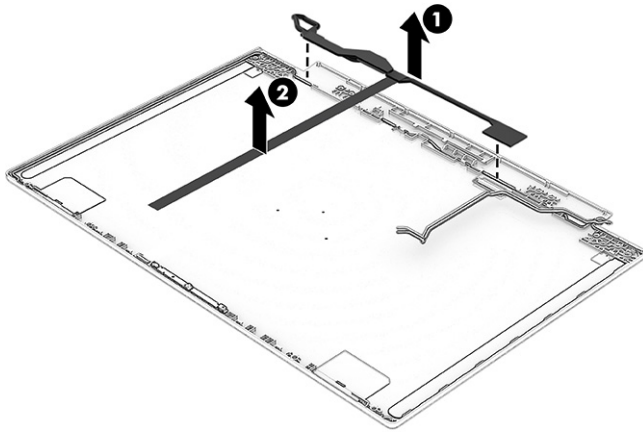

10. To remove the wireless antennas, release the antenna cables from the left, bottom, and right of the display rear cover (1), and then peel the tape and antennas off the cover (2). The antennas are secured with adhesive.

The wireless cables and antennas are available as spare part number N49447-001.

Display back covers are available as the following spare part numbers:

N42536-001: Ceramic white, QHD

N42535-001: Ceramic white, FHD

N42540-001: Mica silver, QHD

N42539-001: Mica silver, FHD

N42538-001: Performance blue, QHD

N42537-001: Performance blue, FHD

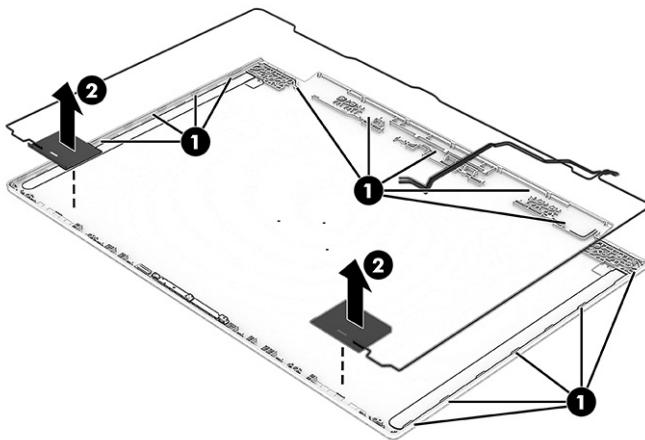

To reassemble and replace the display assembly, reverse these procedures.

## Power connector cable

To remove the power connector cable, use this procedure and illustration.

**Table 6-13 Power connector cable description and part number**

Description	Spare part number
Power connector cable	N42568-001

Before removing the power connector cable, follow these steps:

1. Prepare the computer for disassembly (see [Preparation for disassembly on page 33](#)).
2. Remove the bottom cover (see [Bottom cover on page 38](#)).
3. Remove the battery (see [Battery on page 40](#)).
4. Remove the system board (see [System board with heat sink on page 48](#)).

Remove the power connector cable:

1. Remove the two Phillips M2.5 × 4.5 screws (1) and the Phillips M2.0 × 2.0 screw (2) from the hinge.
2. Rotate the hinge off the power connector (3).
3. Remove the power connector and cable from the computer (4).

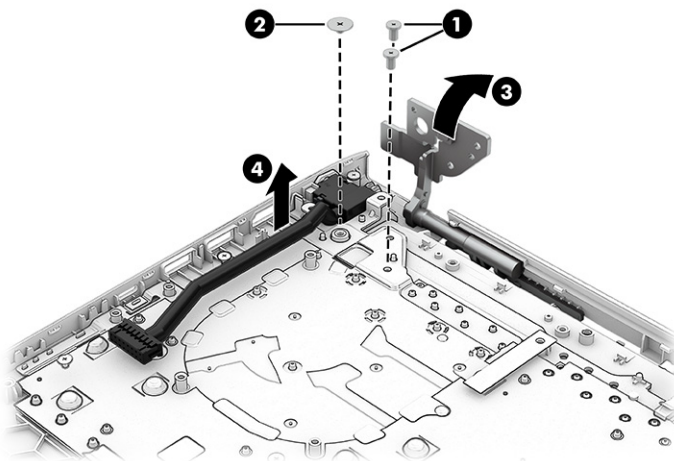

To install the power connector cable, reverse the removal procedure.

## Top cover with keyboard

The top cover with keyboard remains after removing all other spare parts from the computer. In this section, the first table provides the main spare part number for the top covers with keyboards. The second table provides the country codes.

**Table 6-14 Top cover with keyboard descriptions and part numbers**

Description	Spare part number
Ceramic white, RGB, 80 W models	N42466-xxx
Ceramic white, RGB, 60 W models	N42467-xxx
Performance blue, RGB, 80 W models	N42468-xxx

**Table 6-14 Top cover with keyboard descriptions and part numbers (continued)**

Description	Spare part number
Performance blue, 80 W models	N42469-xxx
Performance blue, RGB, 60 W models	N42470-xxx
Performance blue, 60 W models	N42471-xxx
Mica silver, RGB, 80 W models	N42472-xxx
Mica silver, RGB, 60 W models	N42473-xxx
Mica silver, 80 W models	N42474-xxx
Mica silver, 60 W models	N42472-xxx

**Table 6-15 Spare part country codes**

For use in country or region	Spare part number	For use in country or region	Spare part number	For use in country or region	Spare part number
Belgium	-A41	Iceland	-DD1	Slovenia	-BA1
Brazil	-201	India	-D61	South Korea	-AD1
Bulgaria	-261	Israel	-BB1	Spain	-071
Chile	-161	Italy	-061	Switzerland	-BG1
Czech Republic/Slovakia	-FL1	Japan	-291	Taiwan	-AB1
Denmark, Finland, and Norway	-DH1	The Netherlands	-B31	Thailand	-281
French Canada	-DB1	Northern Africa	-FP1	Turkey	-141
France	-051	Portugal	-131	Ukraine	-BD1
Germany	-041	Romania	-271	United Kingdom	-031
Greece	-151	Russia	-251	United States	-001
Hungary	-211	Saudi Arabia	-171		

---

## 7 Using Setup Utility (BIOS)

Setup Utility, or Basic Input/Output System (BIOS), controls communication between all the input and output devices on the system (such as disk drives, display, keyboard, mouse, and printer). Setup Utility (BIOS) includes settings for the types of devices installed, the startup sequence of the computer, and the amount of system and extended memory.

---

 **NOTE:** To start Setup Utility on convertible computers, your computer must be in notebook mode and you must use the keyboard attached to your notebook.

---

### Starting Setup Utility (BIOS)

You have several ways to access the Setup Utility (BIOS).

---

 **IMPORTANT:** Use extreme care when making changes in Setup Utility (BIOS). Errors can prevent the computer from operating properly.

---

- Turn on or restart the computer and quickly press **f10**.

- or -

Turn on or restart the computer, quickly press **esc**, and then press **f10** when the Start menu is displayed.

### Updating Setup Utility (BIOS)

Updated versions of Setup Utility (BIOS) might be available on the HP website. Most BIOS updates on the HP website are packaged in compressed files called *SoftPaqs*. Some download packages contain a file named *Readme.txt*, which contains information regarding installing and troubleshooting the file.

### Determining the BIOS version

To decide whether you need to update Setup Utility (BIOS), first determine the BIOS version on your computer.

To reveal the BIOS version information (also known as *ROM date* and *System BIOS*), use one of these options.

- HP Support Assistant
  1. Select the **Search** icon in the taskbar, type `support` in the search box, and then select the **HP Support Assistant** app.

- or -

Select the question mark icon in the taskbar.

  2. Under **My notebook**, select **Specifications**.
- Setup Utility (BIOS)
  1. Start Setup Utility (BIOS) (see [Starting Setup Utility \(BIOS\) on page 65](#)).

2. Select **Main**, and then make note of the BIOS version.
  3. Select **Exit**, select one of the options, and then follow the on-screen instructions.
- In Windows, press **ctrl+alt+s**.

To check for later BIOS versions, see [Preparing for a BIOS update on page 66](#).

## Preparing for a BIOS update

Be sure to follow all prerequisites before downloading and installing a BIOS update.

 **IMPORTANT:** To reduce the risk of damage to the computer or an unsuccessful installation, download and install a BIOS update only when the computer is connected to reliable external power using the AC adapter. Do not download or install a BIOS update while the computer is running on battery power, docked in an optional docking device, or connected to an optional power source. During the download and installation, follow these instructions:

- Do not disconnect power from the computer by unplugging the power cord from the AC outlet.
- Do not shut down the computer or initiate Sleep.
- Do not insert, remove, connect, or disconnect any device, cable, or cord.

 **NOTE:** If your computer is connected to a network, consult the network administrator before installing any software updates, especially system BIOS updates.

## Downloading a BIOS update

After you review the prerequisites, you can check for and download BIOS updates.

1. Select the **Search** icon in the taskbar, type `support` in the search box, and then select the **HP Support Assistant** app.  
- or -  
Select the question mark icon in the taskbar.
2. Select **Updates**. The **Checking for Updates** window opens, and Windows checks for updates.
3. Follow the on-screen instructions.
4. At the download area, follow these steps:
  - a. Identify the most recent BIOS update and compare it to the BIOS version currently installed on your computer. If the update is more recent than your BIOS version, make a note of the date, name, or other identifier. You might need this information to locate the update later, after it has been downloaded to your hard drive.
  - b. Follow the on-screen instructions to download your selection to the hard drive.

Make a note of the path to the location on your hard drive where the BIOS update is downloaded. You will need to access this path when you are ready to install the update.

## Installing a BIOS update

BIOS installation procedures vary. Follow any instructions that appear on the screen after the download is complete. If no instructions appear, follow these steps.

1. Select the **Search** icon in the taskbar, type `file` in the search box, and then select **File Explorer**.

2. Select your hard drive designation. The hard drive designation is typically Local Disk (C:).
3. Using the hard drive path you recorded earlier, open the folder that contains the update.
4. Double-click the file that has an .exe extension (for example, *filename.exe*).

The BIOS installation begins.

5. Complete the installation by following the on-screen instructions.



**NOTE:** After a message on the screen reports a successful installation, you can delete the downloaded file from your hard drive.

---

---

## 8 Backing up, restoring, and recovering

You can use Windows tools or HP software to back up your information, create a restore point, reset your computer, create recovery media, or restore your computer to its factory state. Performing these standard procedures can return your computer to a working state faster.

 **IMPORTANT:** If you are performing recovery procedures on a tablet, the tablet battery must be at least 70% charged before you start the recovery process.

 **IMPORTANT:** For a tablet with a detachable keyboard, connect the tablet to the keyboard base before beginning any recovery process.

---

### Backing up information and creating recovery media

These methods of creating recovery media and backups are available on select products only.

#### Using Windows tools for backing up

HP recommends that you back up your information immediately after initial setup. You can do this task either using Windows Backup locally with an external USB flash drive or using online tools.

 **NOTE:** If computer storage is 32 GB or less, Microsoft® System Restore is disabled by default.

---

#### Using the HP Cloud Recovery Download Tool to create recovery media (select products only)

You can use the HP Cloud Recovery Download Tool to create HP Recovery media on a bootable USB flash drive.

For details:

- Go to <http://www.hp.com>, search for HP Cloud Recovery, and then select the result that matches the type of computer that you have.

 **NOTE:** If you cannot create recovery media yourself, contact support to obtain recovery discs. Go to <http://www.hp.com/support>, select your country or region, and then follow the on-screen instructions.

 **IMPORTANT:** HP recommends that you follow the [Restoring and recovery methods on page 69](#) to restore your computer before you obtain and use the HP recovery discs. Using a recent backup can return your machine to a working state sooner than using the HP recovery discs. After the system is restored, reinstalling all the operating system software released since your initial purchase can be a lengthy process.

---

### Restoring and recovering your system

You have several tools available to recover your system both within and outside of Windows if the desktop cannot load.

HP recommends that you attempt to restore your system using the [Restoring and recovery methods on page 69](#).

## Creating a system restore

System Restore is available in Windows. The System Restore software can automatically or manually create restore points, or snapshots, of the system files and settings on the computer at a particular point.

When you use System Restore, it returns your computer to its state at the time you made the restore point. Your personal files and documents should not be affected.

## Restoring and recovery methods

After you run the first method, test to see whether the issue still exists before you proceed to the next method, which might now be unnecessary.

1. Run a Microsoft System Restore.
2. Run Reset this PC.

---

 **NOTE:** The options **Remove everything** and then **Fully clean the drive** can take several hours to complete and leave no information on your computer. It is the safest way to reset your computer before you recycle it.

---

3. Recover using HP Recovery media. For more information, see [Recovering using HP Recovery media on page 69](#).

For more information about the first two methods, see the Get Help app:

- Select the **Start** button, select **All apps**, select the **Get Help** app, and then enter the task you want to perform.

---

 **NOTE:** You must be connected to the internet to access the Get Help app.

---

## Recovering using HP Recovery media

You can use HP Recovery media to recover the operating system and drivers that were installed at the factory. On select products, you can create recovery media on a bootable USB flash drive using the HP Cloud Recovery Download Tool.

For details, see [Using the HP Cloud Recovery Download Tool to create recovery media \(select products only\) on page 68](#).

---

 **NOTE:** If you cannot create recovery media yourself, contact support to obtain recovery discs. Go to <http://www.hp.com/support>, select your country or region, and then follow the on-screen instructions.

---

To recover your system:

- Insert the HP Recovery media, and then restart the computer.

---

 **NOTE:** HP recommends that you follow the [Restoring and recovery methods on page 69](#) to restore your computer before you obtain and use the HP recovery discs. Using a recent backup can return your machine to a working state sooner than using the HP recovery discs. After the system is restored, reinstalling all the operating system software released since your initial purchase can be a lengthy process.

---

## Changing the computer boot order

If your computer does not restart using the HP Recovery media, you can change the computer boot order, which is the order of devices listed in BIOS for startup information. You can select an optical drive or a USB flash drive, depending on the location of your HP Recovery media.

---

 **IMPORTANT:** For a tablet with a detachable keyboard, connect the tablet to the keyboard base before beginning these steps.

---

To change the boot order:

1. Insert the HP Recovery media.
2. Access the system **Startup** menu.
  - For computers or tablets with keyboards attached, turn on or restart the computer or tablet, quickly press **esc**, and then press **f9** for boot options.
  - For tablets without keyboards, turn on or restart the tablet, quickly press and hold the volume up button, and then select **f9**.

– or –

Turn on or restart the tablet, quickly press and hold the volume down button, and then select **f9**.
3. Select the optical drive or USB flash drive from which you want to boot, and then follow the on-screen instructions.

## Using HP Sure Recover (select products only)

Select computer models are configured with HP Sure Recover, a PC operating system (OS) recovery solution built into the hardware and software. HP Sure Recover can fully restore the HP OS image without installed recovery software.

Using HP Sure Recover, an administrator or user can restore the system and install:

- Latest version of the operating system
- Platform-specific device drivers
- Software applications, in the case of a custom image

To access the latest documentation for HP Sure Recover, go to <http://www.hp.com/support>. Follow the on-screen instructions to find your product and locate your documentation.

---

## 9 Using HP PC Hardware Diagnostics

You can use the HP PC Hardware Diagnostics utility to determine whether your computer hardware is running properly. The three versions are HP PC Hardware Diagnostics Windows, HP PC Hardware Diagnostics UEFI (Unified Extensible Firmware Interface), and (for select products only) Remote HP PC Hardware Diagnostics UEFI, a firmware feature.

### Using HP PC Hardware Diagnostics Windows (select products only)

HP PC Hardware Diagnostics Windows is a Windows-based utility that allows you to run diagnostic tests to determine whether the computer hardware is functioning properly. The tool runs within the Windows operating system to diagnose hardware failures.

If HP PC Hardware Diagnostics Windows is not installed on your computer, you must download and install it. To download HP PC Hardware Diagnostics Windows, see [Downloading HP PC Hardware Diagnostics Windows on page 72](#).

### Using an HP PC Hardware Diagnostics Windows hardware failure ID code

When HP PC Hardware Diagnostics Windows detects a failure that requires hardware replacement, a 24-digit failure ID code is generated for select component tests. For interactive tests, such as keyboard, mouse, or audio and video palette, you must perform troubleshooting steps before you can receive a failure ID.

- You have several options after you receive a failure ID:
  - Select **Next** to open the Event Automation Service (EAS) page, where you can log the case.
  - Scan the QR code with your mobile device, which takes you to the EAS page, where you can log the case.
  - Select the box next to the 24-digit failure ID to copy your failure code and send it to support.

### Accessing HP PC Hardware Diagnostics Windows

After HP PC Hardware Diagnostics Windows is installed, you can access it from HP Support Assistant or the Start menu.

#### Accessing HP PC Hardware Diagnostics Windows from HP Support Assistant

After HP PC Hardware Diagnostics Windows is installed, follow these steps to access it from HP Support Assistant:

1. Complete one of the following tasks:
  - Select the **Search** icon in the taskbar, type `support` in the search box, and then select the **HP Support Assistant** app.
  - Select the question mark icon in the taskbar.
2. Select **Fixes & Diagnostics**.

3. Select **Run hardware diagnostics**, and then select **Launch**.
4. When the tool opens, select the type of diagnostic test that you want to run, and then follow the on-screen instructions.

---

 **NOTE:** To stop a diagnostic test, select **Cancel**.

---

## Accessing HP PC Hardware Diagnostics Windows from the Start menu (select products only)

After HP PC Hardware Diagnostics Windows is installed, follow these steps to access it from the Start menu:

1. Select the **Start** button, and then select **All apps**.
2. Select **HP PC Hardware Diagnostics Windows**.
3. When the tool opens, select the type of diagnostic test that you want to run, and then follow the on-screen instructions.

---

 **NOTE:** To stop a diagnostic test, select **Cancel**.

---

## Downloading HP PC Hardware Diagnostics Windows

The HP PC Hardware Diagnostics Windows downloading instructions are provided in English only. You must use a Windows computer to download this tool because only .exe files are provided.

### Downloading the latest HP PC Hardware Diagnostics Windows version from HP

To download HP PC Hardware Diagnostics Windows from HP, follow these steps:

1. Go to <http://www.hp.com/go/techcenter/pcdiags>. The HP PC Diagnostics home page is displayed.
2. Select **Download HP Diagnostics Windows**, and then select the specific Windows diagnostics version to download to your computer or a USB flash drive.

The tool downloads to the selected location.

### Downloading the HP PC Hardware Diagnostics Windows from the Microsoft Store

You can download the HP PC Hardware Diagnostics Windows from the Microsoft Store:

1. Select the Microsoft Store app on your desktop or select the **Search** icon in the taskbar, and then type `Microsoft Store` in the search box.
2. Type `HP PC Hardware Diagnostics Windows` in the **Microsoft Store** search box.
3. Follow the on-screen directions.

The tool downloads to the selected location.

### Downloading HP Hardware Diagnostics Windows by product name or number (select products only)

You can download HP PC Hardware Diagnostics Windows by product name or number.

---

 **NOTE:** For some products, you might have to download the software to a USB flash drive by using the product name or number.

---

1. Go to <http://www.hp.com/support>.
2. Select **Software and Drivers**, select your type of product, and then enter the product name or number in the search box that is displayed.
3. In the **Diagnostics** section, select **Download**, and then follow the on-screen instructions to select the specific Windows diagnostics version to be downloaded to your computer or USB flash drive.

The tool downloads to the selected location.

## Installing HP PC Hardware Diagnostics Windows

To install HP PC Hardware Diagnostics Windows, navigate to the folder on your computer or the USB flash drive where the .exe file downloaded, double-click the .exe file, and then follow the on-screen instructions.

## Using HP PC Hardware Diagnostics UEFI

HP PC Hardware Diagnostics Unified Extensible Firmware Interface (UEFI) allows you to run diagnostic tests to determine whether the computer hardware is functioning properly. The tool runs outside the operating system so that it can isolate hardware failures from issues that are caused by the operating system or other software components.



---

**NOTE:** For some products, you must use a Windows computer and a USB flash drive to download and create the HP UEFI support environment because only .exe files are provided. For more information, see [Downloading HP PC Hardware Diagnostics UEFI to a USB flash drive on page 74](#).

---

If your PC does not start in Windows, you can use HP PC Hardware Diagnostics UEFI to diagnose hardware issues.

## Using an HP PC Hardware Diagnostics UEFI hardware failure ID code

When HP PC Hardware Diagnostics UEFI detects a failure that requires hardware replacement, a 24-digit failure ID code is generated.

For assistance in solving the problem, complete one of these tasks:

- Select **Contact HP**, accept the HP privacy disclaimer, and then use a mobile device to scan the failure ID code that appears on the next screen. The HP Customer Support - Service Center page appears with your failure ID and product number automatically filled in. Follow the on-screen instructions.
- Contact support, and provide the failure ID code.

## Starting HP PC Hardware Diagnostics UEFI

To start HP PC Hardware Diagnostics UEFI, follow this procedure.

1. Turn on or restart the computer, and quickly press **esc**.
2. Press **f2**.

The BIOS searches three places for the diagnostic tools, in the following order:

- a. Connected USB flash drive



---

**NOTE:** To download the HP PC Hardware Diagnostics UEFI tool to a USB flash drive, see [Downloading the latest HP PC Hardware Diagnostics UEFI version on page 74](#).

---

- b. Hard drive
  - c. BIOS
3. When the diagnostic tool opens, select the type of diagnostic test that you want to run, and then follow the on-screen instructions.

## Starting HP PC Hardware Diagnostics UEFI through HP Hotkey Support software (select products only)

To start HP PC Hardware Diagnostics UEFI through HP Hotkey Support software, follow this procedure.

1. From the **Start** menu, open the HP System Information Application or enter Fn+Esc.
2. In HP System Information screen, select **Run System Diagnostics**, select **Yes** to run the application, and then select **Restart**.



---

**IMPORTANT:** To prevent loss of data, save your work in all open apps before restarting your computer.



**NOTE:** When the restart is complete, the computer will boot to HP PC Hardware Diagnostics UEFI Application. Proceed with the troubleshooting tests.

---

## Downloading HP PC Hardware Diagnostics UEFI to a USB flash drive

Downloading HP PC Hardware Diagnostics UEFI to a USB flash drive can be useful in some situations.

- HP PC Hardware Diagnostics UEFI is not included in the preinstallation image.
- HP PC Hardware Diagnostics UEFI is not included in the HP Tool partition.
- The hard drive is damaged.



---

**NOTE:** The HP PC Hardware Diagnostics UEFI downloading instructions are provided in English only, and you must use a Windows computer to download and create the HP UEFI support environment because only .exe files are provided.

---

## Downloading the latest HP PC Hardware Diagnostics UEFI version

To download the latest HP PC Hardware Diagnostics UEFI version to a USB flash drive, follow this procedure:

1. Go to <http://www.hp.com/go/techcenter/pcdiags>. The HP PC Diagnostics home page is displayed.
2. Select **Download HP Diagnostics UEFI**, and then select **Run**.

## Downloading HP PC Hardware Diagnostics UEFI by product name or number (select products only)

You can download HP PC Hardware Diagnostics UEFI by product name or number (select products only) to a USB flash drive.

---

 **NOTE:** For some products, you might have to download the software to a USB flash drive by using the product name or number.

---

1. Go to <http://www.hp.com/support>.
2. Enter the product name or number, select your computer, and then select your operating system.
3. In the **Diagnostics** section, follow the on-screen instructions to select and download the specific UEFI Diagnostics version for your computer.

## Using Remote HP PC Hardware Diagnostics UEFI settings (select products only)

Remote HP PC Hardware Diagnostics UEFI is a firmware (BIOS) feature that downloads HP PC Hardware Diagnostics UEFI to your computer. It can then run the diagnostics on your computer, and it might upload results to a preconfigured server.

For more information about Remote HP PC Hardware Diagnostics UEFI, go to <http://www.hp.com/go/techcenter/pcdiags>, and then select **Find out more**.

## Downloading Remote HP PC Hardware Diagnostics UEFI

HP Remote PC Hardware Diagnostics UEFI is also available as a SoftPaq that you can download to a server.

## Downloading the latest Remote HP PC Hardware Diagnostics UEFI version

You can download the latest HP PC Hardware Diagnostics UEFI version to a USB flash drive.

1. Go to <http://www.hp.com/go/techcenter/pcdiags>. The HP PC Diagnostics home page is displayed.
2. Select **Download Remote Diagnostics**, and then select **Run**.

## Downloading Remote HP PC Hardware Diagnostics UEFI by product name or number

You can download HP Remote PC Hardware Diagnostics UEFI by product name or number.

---

 **NOTE:** For some products, you might have to download the software by using the product name or number.

---

1. Go to <http://www.hp.com/support>.
2. Select **Software and Drivers**, select your type of product, enter the product name or number in the search box that is displayed, select your computer, and then select your operating system.
3. In the **Diagnostics** section, follow the on-screen instructions to select and download the **Remote UEFI** version for the product.

## Customizing Remote HP PC Hardware Diagnostics UEFI settings

Using the Remote HP PC Hardware Diagnostics setting in Computer Setup (BIOS), you can perform several customizations.

- Set a schedule for running diagnostics unattended. You can also start diagnostics immediately in interactive mode by selecting **Execute Remote HP PC Hardware Diagnostics**.
- Set the location for downloading the diagnostic tools. This feature provides access to the tools from the HP website or from a server that has been preconfigured for use. Your computer does not require the traditional local storage (such as a hard drive or USB flash drive) to run remote diagnostics.
- Set a location for storing the test results. You can also set the user name and password that you use for uploads.
- Display status information about the diagnostics run previously.

To customize Remote HP PC Hardware Diagnostics UEFI settings, follow these steps:

1. Turn on or restart the computer, and when the HP logo appears, press **f10** to enter Computer Setup.
2. Select **Advanced**, and then select **Settings**.
3. Make your customization selections.
4. Select **Exit**, then select **Save Changes and Exit** to save your settings.

Your changes take effect when the computer restarts.

# 10 Specifications

This chapter provides specifications for your computer system.

## Computer specifications

This section provides specifications for your computer. When traveling with your computer, the computer dimensions and weights, as well as input power ratings and operating specifications, provide helpful information.

**Table 10-1** Computer specifications

	Metric	U.S.
<b>Dimensions</b>		
Width	369.0 mm	14.50 in
Depth	259.4 mm	10.20 in
Height (front to back)	22.9 mm - 23.9 mm	0.90 in - 0.94 in
<b>Weight</b>	2300 g	5.07 lb
<b>Input power</b>		
Operating voltage and current	19.5 V DC @ 11.8 A - 230 W	
	19.5 V DC @ 10.3 A - 200 W	
	19.5 V DC @ 7.70 A - 140 W	
<b>Temperature</b>		
Operating	5°C to 35°C	41°F to 95°F
Nonoperating	-20°C to 60°C	-4°F to 140°F
<b>Relative humidity</b> (noncondensing)		
Operating	10% to 90%	
Nonoperating	5% to 95%	
<b>Maximum altitude</b> (unpressurized)		
Operating	-15 m to 3,048 m	-50 ft to 10,000 ft
Nonoperating	-15 m to 12,192 m	-50 ft to 40,000 ft

**NOTE:** Applicable product safety standards specify thermal limits for plastic surfaces. The device operates well within this range of temperatures.

## 40.9 cm (16.1 in) display specifications

This section provides specifications for your display.

**Table 10-2 Display specifications**

	<b>Metric</b>	<b>U.S.</b>
Active diagonal size	<b>40.9 cm</b>	16.1 in
Resolution	2560 × 1440 (QHD) 1920 × 1080 (FHD)	
Surface treatment	Antiglare	
Brightness	250 nits 300 nits	
Viewing angle	UWVA	
Backlight	WLED	
Display panel interface	eDP	

## Solid-state drive specifications

This section provides specifications for your solid-state drives.

**Table 10-3 Solid-state drive specifications**

	<b>256 GB*</b>	<b>512 GB*</b>	<b>1TB*</b>
<b>Dimensions</b>			
Height	1.0 mm	1.0 mm	1.0 mm
Length	50.8 mm	50.8 mm	50.8 mm
Width	28.9 mm	28.9 mm	28.9 mm
Weight	< 10 g	< 10 g	< 10 g
<b>Interface type</b>			
Ready time, maximum (to not busy)	1.0 ms	< 1.0 ms	1.0 ms
Access times, logical	0.1 ms	0.1 ms	0.1 ms
<b>Transfer rate</b>			
Sequential read	up to 2150 MBps	up to 2150 MBps	up to 2150 MBps
Random read	Up to 300,000 IOPs	Up to 300,000 IOPs	Up to 300,000 IOPs
Sequential write	up to 1550 MBps	up to 1550 MBps	up to 1550 MBps
Random write	Up to 100,000 IOPs	Up to 100,000 IOPs	Up to 100,000 IOPs
<b>Total logical sectors</b>	468,883,296	1,000,215,216	1,500,336,388
<b>Operating temperature</b>	<b>0°C to 70°C (32°F to 158°F)</b>		

\*1 GB = 1 billion bytes when referring to hard drive storage capacity. Actual accessible capacity is less. Actual drive specifications might differ slightly.

**NOTE:** Certain restrictions and exclusions apply. Contact support for details.

# 11 Power cord set requirements

This chapter provides power cord requirements for countries and regions.

The wide-range input feature of the computer permits it to operate from any line voltage from 100 V AC to 120 V AC, or from 220 V AC to 240 V AC.

The three-conductor power cord set included with the computer meets the requirements for use in the country or region where the equipment is purchased.

Power cord sets for use in other countries or regions must meet the requirements of the country and region where the computer is used.

## Requirements for all countries

These power cord requirements are applicable to all countries and regions.

- The length of the power cord set must be at least **1.0 m** (3.3 ft) and no more than **2.0 m** (6.5 ft).
- All power cord sets must be approved by an acceptable accredited agency responsible for evaluation in the country or region where the power cord set will be used.
- The power cord sets must have a minimum current capacity of 10 A and a nominal voltage rating of 125 V AC or 250 V AC, as required by the power system of each country or region.
- The appliance coupler must meet the mechanical configuration of an EN 60 320/IEC 320 Standard Sheet C13 connector for mating with the appliance inlet on the back of the computer.

## Requirements for specific countries and regions

To determine power cord requirements for specific countries and regions, use this table.

**Table 11-1** Power cord requirements for specific countries and regions

Country/region	Accredited agency	Applicable note number
Argentina	IRAM	1
Australia	SAA	1
Austria	OVE	1
Belgium	CEBEC	1
Brazil	ABNT	1
Canada	CSA	2
Chile	IMQ	1
Denmark	DEMKO	1
Finland	FIMKO	1
France	UTE	1

**Table 11-1 Power cord requirements for specific countries and regions (continued)**

Country/region	Accredited agency	Applicable note number
Germany	VDE	1
India	BIS	1
Israel	SII	1
Italy	IMQ	1
Japan	JIS	3
Netherlands	KEMA	1
New Zealand	SANZ	1
Norway	NEMKO	1
People's Republic of China	CCC	4
Saudi Arabia	SASO	7
Singapore	PSB	1
South Africa	SABS	1
South Korea	KTL	5
Sweden	SEMKO	1
Switzerland	SEV	1
Taiwan	BSMI	6
Thailand	TISI	1
United Kingdom	ASTA	1
United States	UL	2

1. The flexible cord must be Type HO5VV-F, three-conductor, 0.75 mm<sup>2</sup> conductor size. Power cord set fittings (appliance coupler and wall plug) must bear the certification mark of the agency responsible for evaluation in the country or region where it will be used.
2. The flexible cord must be Type SVT/SJT or equivalent, No. 18 AWG, three-conductor. The wall plug must be a two-pole grounding type with a NEMA 5-15P (15 A, 125 V AC) or NEMA 6-15P (15 A, 250 V AC) configuration. CSA or C-UL mark. UL file number must be on each element.
3. The appliance coupler, flexible cord, and wall plug must bear a T mark and registration number in accordance with the Japanese Dentori Law. The flexible cord must be Type VCTF, three-conductor, 0.75 mm<sup>2</sup> or 1.25 mm<sup>2</sup> conductor size. The wall plug must be a two-pole grounding type with a Japanese Industrial Standard C8303 (7 A, 125 V AC) configuration.
4. The flexible cord must be Type RVV, three-conductor, 0.75 mm<sup>2</sup> conductor size. Power cord set fittings (appliance coupler and wall plug) must bear the CCC certification mark.
5. The flexible cord must be Type HO5VV-F three-conductor, 0.75 mm<sup>2</sup> conductor size. KTL logo and individual approval number must be on each element. Approval number and logo must be printed on a flag label.
6. The flexible cord must be Type HVCTF three-conductor, 1.25 mm<sup>2</sup> conductor size. Power cord set fittings (appliance coupler, cable, and wall plug) must bear the BSMI certification mark.
7. For 127 V AC, the flexible cord must be Type SVT or SJT 3-conductor, 18 AWG, with plug NEMA 5-15P (15 A, 125 V AC), with UL and CSA or C-UL marks. For 240 V AC, the flexible cord must be Type HO5VV-F three-conductor, 0.75 mm<sup>2</sup> or 1.00 mm<sup>2</sup> conductor size, with plug BS 1363/A with BSI or ASTA marks.

---

## 12 Recycling

When a nonrechargeable or rechargeable battery has reached the end of its useful life, do not dispose of the battery in general household waste. Follow the local laws and regulations in your area for battery disposal.

HP encourages customers to recycle used electronic hardware, HP original print cartridges, and rechargeable batteries. For more information about recycling programs, see the HP website at <http://www.hp.com/recycle>.

---

# Index

- A**
  - AC adapter and battery light, identifying 6
  - AC adapters, spare part numbers 22
  - action key, identifying 12
  - audio board
    - removal 46
    - spare part numbers 46
  - audio-out (headphone)/audio-in (microphone) combo jack, identifying 7
  - audio, product description 2
- B**
  - backup, creating 68
  - backups 68
  - battery
    - illustrated 19
    - spare part number 19
  - BIOS
    - determining version 65
    - downloading an update 66
    - starting the Setup Utility 65
    - updating 65
  - Bluetooth label 14
  - boot order, changing 70
  - bottom components 13
  - bottom cover
    - illustrated 19
    - removal 38
    - spare part number 19, 38
  - buttons
    - left touchpad 9
    - power 12
    - right touchpad 9
- C**
  - calculator key, identifying 12
  - camera
    - identifying 8
    - illustrated 21
    - spare part number 21
  - camera light, identifying 8
  - camera privacy cover, identifying 8
  - caps lock light 11
  - caring for your computer 28
  - cautions
    - electrostatic discharge 24, 25
  - cleaning your computer 28
    - caring for wood veneer 30
    - disinfecting 29
    - HP Easy Clean 28
    - removing dirt and debris 28
  - components
    - bottom 13
    - display 7
    - keyboard area 9
    - left side 6
    - lights 10
    - rear 14
    - right side 5
    - touchpad 9
  - computer major components 17
  - computer specifications 77
  - connectors
    - power 6
  - control zone 9
- D**
  - display
    - specifications 77
  - display assembly
    - subcomponents 20
  - display back cover
    - illustrated 22
    - spare part number 22
  - display bezel
    - illustrated 21
    - spare part number 21
  - display cable
    - illustrated 22
    - spare part number 22
  - display components 7
  - display panel
    - illustrated 21
    - product description 1
    - spare part number 21
- E**
  - electrostatic discharge (ESD) 24, 25
    - preventing damage 24-26
- F**
  - esc key, identifying 12
  - fan
    - illustrated 20
    - spare part number 20
  - fans
    - removal 51
    - spare part number 51
  - fn key, identifying 12
- G**
  - graphics, product description 1
  - grounding methods 24-26
  - guidelines
    - packaging 24, 30
    - transporting 24, 30
    - workstation 24
- H**
  - hard drive
    - product description 2
    - specifications 77
  - HDMI port
    - identifying 5
  - heat sink
    - illustrated 19
    - removal 47
    - spare part number 19, 47
  - hinge
    - illustrated 21
    - spare part number 21
  - HP OMEN Gaming Hub, using 15
  - HP PC Hardware Diagnostics UEFI
    - downloading 74
    - failure ID code 73
    - HP Hotkey Support software 74
    - starting 73, 74
    - using 73
  - HP PC Hardware Diagnostics Windows
    - accessing 71, 72
    - downloading 72
    - failure ID code 71
    - installing 73
    - using 71

HP Recovery media  
  recovery 69  
HP Sure Recover 70

## I

illustrated parts catalog 17  
integrated numeric keypad,  
  identifying 13  
internal microphones,  
  identifying 8  
IR board  
  removal 53  
  spare part numbers 53

## J

jacks  
  audio-out (headphone)/audio-in  
    (microphone) 7  
  network 6  
  RJ-45 (network) 6

## K

keyboard  
  product description 3  
keyboard with top cover  
  spare part numbers 63  
keypad, integrated numeric 13  
keys  
  action 12  
  calculator 12  
  esc 12  
  fn 12  
  num lock 13  
  OMEN 13  
  Windows 12

## L

labels  
  Bluetooth 14  
  regulatory 14  
  serial number 14  
  service 14  
  wireless certification 14  
  WLAN 14  
left control zone, identifying 9, 10  
left side components 6  
lights  
  AC adapter and battery 6  
  camera 8  
  caps lock 11  
  mute 11  
  power 11  
  RJ-45 (network) status 6

  touchpad 9, 11  
low blue light mode 7

## M

memory module  
  product description 2  
memory modules  
  illustrated 18  
  removal 35  
  spare part number 18  
  spare part numbers 35  
microphone  
  product description 2  
miscellaneous parts, spare part  
  number 22  
model name 1  
mute light, identifying 11

## N

network jack, identifying 6  
num lock key, identifying 13

## O

OMEN key, identifying 13  
operating system, product  
  description 3

## P

packaging guidelines 24, 30  
pointing device, product  
  description 3  
ports  
  HDMI 5  
  product description 2  
  USB 5 Gbps signaling rate 5  
  USB 5 Gbps signaling rate port  
    with HP Sleep and  
    Charge 6  
  USB Type-C 5 Gbps signaling  
    rate power connector port  
    with HP Sleep and Charge  
    and DisplayPort output 5  
power button, identifying 12  
power connector  
  identifying 6  
power connector cable  
  removal 62  
  spare part numbers 62  
power cord  
  requirements for all  
    countries 79  
  requirements for specific  
    countries and regions 79

  set requirements 79  
power cords, spare part  
  numbers 22  
power light, identifying 11  
power requirements, product  
  description 3  
primary storage  
  product description 2  
processor  
  product description 1  
product description  
  audio 2  
  display panel 1  
  graphics 1  
  hard drive 2  
  keyboard 3  
  memory module 2  
  microphone 2  
  operating system 3  
  pointing device 3  
  ports 2  
  power requirements 3  
  primary storage 2  
  processors 1  
  product name 1  
  security 3  
  serviceability 4  
  solid-state drive 2  
  video 2  
  wireless 2  
product name 1  
product name and number,  
  computer 14

## R

recovery 68  
  discs 69  
  media 69  
  USB flash drive 69  
recovery media 68  
  creating using HP Cloud  
    Recovery Download  
    Tool 68  
  creating using Windows  
    tools 68  
regulatory information  
  regulatory label 14  
  wireless certification labels 14  
Remote HP PC Hardware  
  Diagnostics UEFI settings  
  customizing 76  
  using 75  
removal and replacement  
  procedures 33, 38

- solid-state drive 33
- restoring 68
- restoring and recovery methods 69
- right control zone, identifying 9, 10
- right side components 5
- RJ-45 (network) jack, identifying 6
- RJ-45 (network) status lights, identifying 6
- RJ-45 door
  - illustrated 19
  - removal 40
  - spare part number 19
  - spare part numbers 40

**S**

- Screw Kit, spare part number 22
- security, product description 3
- serial number, computer 14
- service labels, locating 14
- serviceability, product description 4
- solid-state drive
  - illustrated 18
  - product description 2
  - removal and replacement 33
  - spare part number 18
  - specifications 78
- spare part country codes 63
- speaker
  - illustrated 18
  - removal 43
  - spare part number 18
  - spare part numbers 43
- speakers 13
- special keys
  - identifying 11
  - using 11
- specifications
  - computer 77
  - display 77
  - hard drive 77
  - solid-state drive 78
- static electricity 24, 25
- support information 31
- system board
  - removal 48
  - spare part numbers 48
- system restore 69
- system restore point, creating 68

**T**

- top cover/keyboard
  - illustrated 18
  - spare part number 18
- touchpad
  - illustrated 18
  - removal 44
  - settings 9
  - spare part number 18
  - spare part numbers 44
- touchpad buttons
  - identifying 9
- touchpad components 9
- touchpad light, identifying 9, 11
- touchpad settings, adjusting 9
- touchpad zone, identifying 9, 10
- transporting guidelines 24, 30
- traveling with the computer 14

**U**

- USB 5 Gbps signaling rate port with HP Sleep and Charge, identifying 6
- USB board
  - illustrated 19
  - spare part number 19
- USB port with 5 Gbps signaling rate, identifying 5
- USB Type-C 5 Gbps signaling rate power connector port with HP Sleep and Charge and DisplayPort output, identifying 5
- USB/network board
  - removal 52
  - spare part numbers 52

**V**

- vents, identifying 6, 13, 14
- video, product description 2

**W**

- Windows
  - backup 68
  - recovery media 68
  - system restore point 68
- Windows key, identifying 12
- Windows tools, using 68
- wireless antennas
  - illustrated 22
  - spare part number 22
- wireless antennas, identifying 8
- wireless certification label 14

- wireless, product description 2
- WLAN antennas, identifying 8
- WLAN device 14
- WLAN label 14
- WLAN module
  - illustrated 18
  - removal 42
  - spare part number 18
  - spare part numbers 42
- workstation guidelines 24