



Maintenance and Service Guide

HP Pavilion x360 14m Convertible PC
IMPORTANT! This document is intended for
HP authorized service providers only.

© Copyright 2018 HP Development Company, L.P.

Bluetooth is a trademark owned by its proprietor and used by HP Inc. under license. Intel, Core, and Pentium are U.S. registered trademarks of Intel Corporation. Microsoft and Windows are either registered trademarks or trademarks of Microsoft Corporation in the United States and/or other countries. SD Logo is a trademark of its proprietor.

The information contained herein is subject to change without notice. The only warranties for HP products and services are set forth in the express warranty statements accompanying such products and services. Nothing herein should be construed as constituting an additional warranty. HP shall not be liable for technical or editorial errors or omissions contained herein.

Second Edition: September 2018

First Edition: April 2018

Document Part Number: L24219-002

Product notice

This user guide describes features that are common to most models. Some features may not be available on your computer.

Not all features are available in all editions of Windows. This computer may require upgraded and/or separately purchased hardware, drivers and/or software to take full advantage of Windows functionality. Go to <http://www.microsoft.com> for details.

Software terms

By installing, copying, downloading, or otherwise using any software product preinstalled on this computer, you agree to be bound by the terms of the HP End User License Agreement (EULA). If you do not accept these license terms, your sole remedy is to return the entire unused product (hardware and software) within 14 days for a full refund subject to the refund policy of your seller.

For any further information or to request a full refund of the price of the computer, please contact your seller.

Safety warning notice

 **WARNING!** To reduce the possibility of heat-related injuries or of overheating the device, do not place the device directly on your lap or obstruct the device air vents. Use the device only on a hard, flat surface. Do not allow another hard surface, such as an adjoining optional printer, or a soft surface, such as pillows or rugs or clothing, to block airflow. Also, do not allow the AC adapter to contact the skin or a soft surface, such as pillows or rugs or clothing, during operation. The device and the AC adapter comply with the user-accessible surface temperature limits defined by the International Standard for Safety of Information Technology Equipment (IEC 60950-1).

Table of contents

1 Product description	1
2 Getting to know your computer	6
Right side	6
Left side	7
Display	9
Keyboard area	10
TouchPad	10
Lights	11
Speakers and camera	12
Special keys	13
Action keys	14
Bottom	15
Labels	16
3 Illustrated parts catalog	17
Computer major components	18
Cables	22
Mass storage devices	23
Miscellaneous Parts Kit	24
Miscellaneous parts	26
4 Removal and replacement preliminary requirements	27
Tools required	27
Service considerations	27
Plastic parts	27
Cables and connectors	27
Drive handling	28
Grounding guidelines	29
Electrostatic discharge damage	29
Packaging and transporting guidelines	30
Workstation guidelines	30
5 Removal and replacement procedures	32
Component replacement procedures	32
Bottom cover	33

Battery	35
Solid-state drive	36
Optane memory module	37
WLAN module	38
Hard drive	40
Memory module	43
Power button board	46
Fingerprint reader board	47
TouchPad	48
Speakers	50
Camera, world-facing	51
Display assembly	52
Power connector cable	55
System board	56
USB/audio board	60
Fan/heat sink assembly	61
Top cover with keyboard	65

6 Using Setup Utility (BIOS) 66

Starting Setup Utility (BIOS)	66
Updating Setup Utility (BIOS)	66
Determining the BIOS version	66
Downloading a BIOS update	67

7 Using HP PC Hardware Diagnostics 68

Using HP PC Hardware Diagnostics Windows	68
Downloading HP PC Hardware Diagnostics Windows	68
Downloading the latest HP PC Hardware Diagnostics Windows version	69
Downloading HP Hardware Diagnostics Windows by product name or number (select products only)	69
Installing HP PC Hardware Diagnostics Windows	69
Using HP PC Hardware Diagnostics UEFI	69
Starting HP PC Hardware Diagnostics UEFI	70
Downloading HP PC Hardware Diagnostics UEFI to a USB flash drive	70
Downloading the latest HP PC Hardware Diagnostics UEFI version	70
Downloading HP PC Hardware Diagnostics UEFI by product name or number (select products only)	70
Using Remote HP PC Hardware Diagnostics UEFI settings (select products only)	71
Downloading Remote HP PC Hardware Diagnostics UEFI	71
Downloading the latest Remote HP PC Hardware Diagnostics UEFI version	71
Downloading Remote HP PC Hardware Diagnostics UEFI by product name or number ...	71

Customizing Remote HP PC Hardware Diagnostics UEFI settings	71
8 Backing up, restoring, and recovering	73
Using Windows tools	73
Creating HP Recovery media (select products only)	73
Using HP Recovery Manager to create recovery media	74
Before you begin	74
Creating the recovery media	74
Using the HP Cloud Recovery Download Tool to create recovery media	74
Restoring and recovery	75
Restoring, resetting, and refreshing using Windows tools	75
Restoring using HP Recovery Manager and the HP Recovery partition	75
Recovering using HP Recovery Manager	75
Recovering using the HP Recovery partition (select products only)	76
Recovering using HP Recovery media	76
Changing the computer boot order	77
Removing the HP Recovery partition (select products only)	77
9 Specifications	78
10 Power cord set requirements	79
Requirements for all countries	79
Requirements for specific countries and regions	79
11 Recycling	81
Index	82

1 Product description

Category	Description	UMA	Discrete
Product Name	HP Pavilion x360 14m Convertible PC <i>Models: 14m-cd0xxx, 14-cd1xx, 14-cd0xxx, 14t-cd000, 14q-cd1xxx, 14t-cd100</i>	√	√
Processors	8th generation Intel® Core™ processors:	√	√
	i7-8565U 1.80-GHz (SC turbo up to 4.60-GHz) quad core processor (8.0-MB L3 cache, 2400-MHz FSB, 15 W)		√
	i7-8550U 1.80-GHz (SC turbo up to 4.00-GHz) quad core processor (8.0-MB L3 cache, 2400-MHz FSB, 15 W)		√
	i5-8265U 1.60-GHz (SC turbo up to 3.90-GHz) quad core processor (6.0-MB L3 cache, 2400-MHz FSB, 15 W)	√	√
	i5-8250U 1.60-GHz (SC turbo up to 3.40-GHz) quad core processor (6.0-MB L3 cache, 2400-MHz FSB, 15 W)	√	√
	i3-8145U 2.10-GHz (SC turbo up to 3.90-GHz), dual core processor (4.0-MB L3 cache, 2400-MHz FSB, 15 W)	√	√
	i3-8130U 2.20-GHz (SC turbo up to 3.40-GHz), dual core processor (4.0-MB L3 cache, 2400-MHz FSB, 15 W)	√	√
	7th generation Intel Pentium™ processor:	√	
	4415U 2.3-GHz dual core processor (2.0-MB L3 cache, 2133-MHz FSB, 15 W)	√	
Chipset	Integrated with system-on-chip (SoC)	√	√
Graphics	Support for HD decode, DX12, and high-definition multimedia interface (HDMI)	√	√
	Supports Optimus		√
	Supports GPS (GPU Performance Scaling)		√
	Supports MR ready	√	√
	Internal graphics:	√	√
	Intel UHD Graphics 620	√	√
	Intel HD Graphics 620	√	√
	Intel HD Graphics Integrated	√	√
	Intel UHD Graphics Integrated	√	√
	Hybrid graphics:		√
	Nvidia GeForce MX130 with up to 4096-MB of discrete video memory		√
	Nvidia GeForce MX130 with up to 2048-MB of discrete video memory		√
Panel	16:9 ultra wide aspect ratio, narrow bezel:	√	√
	<ul style="list-style-type: none"> 14.0-in, full high-definition (FHD)(1920×1080), white light-emitting (WLED), BrightView, slim/flat (3.0-mm), UWVA, eDP, 220 nits or 250 nits 	√	√

Category	Description	UMA	Discrete
	<ul style="list-style-type: none"> 14.0-in, high-definition (HD)(1366×768), WLED, anti glare, slim/flat (3.6-mm), SVA, eDP, 220 nits 	√	√
	Supports Simultaneous Pen & Touch	√	√
	Support for active stylus	√	√
Memory	Two SODIMM memory module slots, non-customer-accessible/non-upgradable	√	√
	Supports up to 12-GB of system memory	√	√
	DDR4-2400 dual channel support	√	√
	DDR4-2133 dual channel support	√	√
	Supports the following configurations:	√	√
	NOTE: 32-bit operating system support up to 4 GB.		
	<ul style="list-style-type: none"> 12288 MB (8192 MB × 1 + 4096 × 1) 	√	√
	<ul style="list-style-type: none"> 8192 MB (8192 MB × 1) 	√	√
	<ul style="list-style-type: none"> 6144 MB (4096 MB × 1 + 2048 MB × 1) 	√	√
	<ul style="list-style-type: none"> 4096 MB (4096 MB × 1) 	√	√
Storage	Single hard drive configurations; 7.2 mm/9.5 mm, SATA, 2.5-inch:	√	√
	1-TB, 5400-rpm, 7.0 mm	√	√
	500-GB, 5400-rpm, 7.0 mm	√	√
	Solid-state hard drive configuration:	√	√
	1-TB, 5400-rpm, 7.2 mm, solid-state hard drive with 8-GB NAND	√	√
	Dual storage configurations:	√	√
	128-GB, TLC, solid-state drive with 1-TB, 5400-rpm hard drive	√	√
	128-GB, TLC, solid-state drive with 500-GB, 5400-rpm hard drive	√	√
	16-GB, PCIe, Optane, solid-state drive with 1-TB, 5400-rpm hard drive	√	√
	M.2, SATA-3, solid-state drive with Triple-Level Cell (TLC):	√	√
	256-GB	√	√
	128-GB	√	√
	PCIe, NVMe, value, M.2, solid-state drive:	√	√
	512-GB	√	√
	256-GB	√	√
Optical drive	HP external DVD±RW DL SuperMulti Drive	√	√
Camera	HP Wide Vision FHD infrared camera with indicator light and 2 infrared lights, USB 2.0, FHD hybrid BSI sensor, f2.2, WDR, 88° wide field of vision	√	√
	1080p by 30 frames per second	√	√
	Support Windows Hello	√	√
	Dual array Digital Microphones w/ appropriate software - beam forming, echo cancellation, noise suppression	√	√

Category	Description	UMA	Discrete
	HP Wide Vision HD camera with indicator light, USB 2.0, HD BSI sensor, f2.0, WDR, 88° wide field of vision	✓	✓
	720p by 30 frames per second	✓	✓
	Dual array Digital Microphones w/ appropriate software - beam forming, echo cancellation, noise suppression	✓	✓
	Front/rear: HP Wide Vision 5 MP Camera with MIPI, BSI sensor, f2.2, 120° WFOV, fixed focus, 5 MP @ 30 frames per second	✓	
Audio	Audio brand: B&O Play	✓	✓
	Audio control panel: B&O Play Audio Control	✓	✓
	Supports HP Audio Boost	✓	✓
	Dual speakers	✓	✓
Sensors	Accelerometer	✓	✓
	Gyroscope/E-compass/Accelerometer	✓	✓
	Integrated sensor hub	✓	✓
Wireless	Integrated wireless options with a single antenna:		
	<ul style="list-style-type: none"> Intel Dual Band Wireless-AC 9461 802.11 AC 1x1 WiFi + Bluetooth 5.0 Combo Adapter (non-vPro) 	✓	✓
	<ul style="list-style-type: none"> Realtek RTL8821CE 802.11 ac 1x1 WiFi + Bluetooth 4.2 Combo Adapter (MU-MIMO supported) 	✓	✓
	Integrated wireless options with dual antennas (M.2/PCIe):		
	<ul style="list-style-type: none"> Intel Dual Band Wireless-AC 7265 802.11 AC 2x2 WiFi + Bluetooth 4.2 Combo Adapter (non-vPro) 	✓	✓
	<ul style="list-style-type: none"> Intel Dual band wireless-AC 3168 802.11AC 1x1 WiFi + Bluetooth 4.2 Combo Adaptor (non-vPro) 	✓	✓
	<ul style="list-style-type: none"> Realtek RTL8822BE 802.11 ac 2x2 WiFi + Bluetooth 4.2 Combo Adapter 	✓	✓
	Compatible with Miracast-certified devices	✓	✓
	WiFi SAR enabled in BIOS (Intel WLAN only)	✓	✓
External memory cards	HP Multi-Format Memory Card Reader	✓	✓
	Supports SD/SDHC/SDXC	✓	✓
	Push-push insertion/removal	✓	✓
Internal card expansion	One M.2 slot for SSD	✓	✓
	One M.2 slot for WLAN	✓	✓
Ports	AC Smart Pin adapter plug	✓	✓
	Audio-out (headphone)/audio-in (microphone) combo jack	✓	✓
	HDMI v1.4 supporting up to 1920×1080 @ 60Hz	✓	✓
	Hot plug/unplug and auto detect for correct output to wide-aspect vs standard aspect video (auto adjust panel resolution to fit embedded panel and external monitor connected)	✓	✓
	USB 3.0 ports	✓	✓

Category	Description	UMA	Discrete
	USB Type-C port; USB 3.1 Gen 1; supports data transfer	√	√
Keyboard/ TouchPad	Keyboard:	√	√
	Full-sized, textured, island-style keyboard	√	√
	Full-sized, three-coat, backlit, island-style keyboard	√	√
	TouchPad:	√	√
	Image sensor	√	√
	MultiTouch gestures enabled	√	√
	Support for Modern TrackPad gestures	√	√
	Taps enabled as default	√	√
Power requirements	Battery:	√	√
	3-cell, 41-WHr, Primus Prismatic battery	√	√
	Supports battery fast charge	√	√
	AC adapter:	√	√
	65-W HP Smart AC adapter (EM) with power cord	√	√
	65-W HP Smart AC adapter with power cord		√
	65-W HP Smart AC adapter (Argentina specific) with power cord	√	√
	45-W HP Smart AC adapter with power cord	√	
	45-W HP Smart AC adapter (Argentina specific) with power cord	√	
	Power cord:	√	√
	1.0 m conventional power cord with a C5 connector	√	√
	1.0 m conventional power cord with a C5 connector + Japan plug adapter	√	√
Security	Nano Security Lock	√	√
	Fingerprint Reader (select models only)	√	√
	Support for Trusted Platform Module (TPM) 2.0	√	√
	U2F (Universal 2nd Factor Authentication)	√	√
Operating system	FreeDOS 2.0	√	√
	Windows 10 Home 64	√	√
	Windows 10 Home 64 Chinese Market CPPP	√	√
	Windows 10 Home 64 High-End Chinese Market CPPP	√	√
	Windows 10 Home 64 Plus	√	√
	Windows 10 Home 64 Plus Single Language	√	√
	Windows 10 Home 64 Plus Single Language APAC EM PPP	√	√
	Windows 10 Home 64 Plus Single Language India Market PPP	√	√
	Windows 10 Home 64 Plus Single Language Indonesia Market PPP	√	√





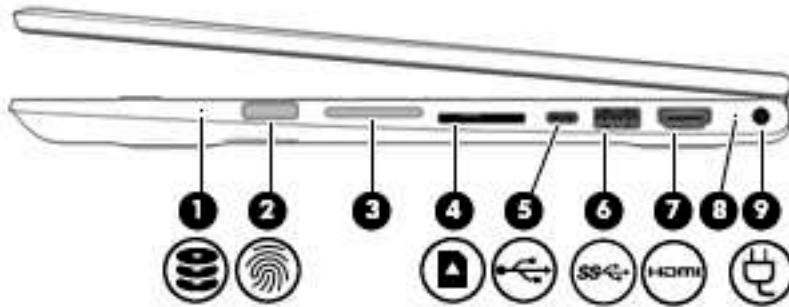

Category	Description	UMA	Discrete
	Windows 10 Home 64 Plus Web/Kiosk	√	√
	Windows 10 Home 64 Single Language	√	√
	Windows 10 Home 64 Single Language APAC EM PPP	√	√
	Windows 10 Home 64 Single Language India Market PPP	√	√
	Windows 10 Home 64 Single Language Indonesia Market PPP	√	√
	Windows 10 Home 64 Single Language SEAP	√	√
	Windows 10 Home 64 Web/Kiosk	√	√
	Windows 10 Pro 64	√	√
	Windows 10 Pro 64 Web/Kiosk	√	√
Serviceability	End user replaceable part: AC adapter	√	√

2 Getting to know your computer

Your computer features top-rated components. This chapter provides details about your components, where they are located, and how they work.

Right side





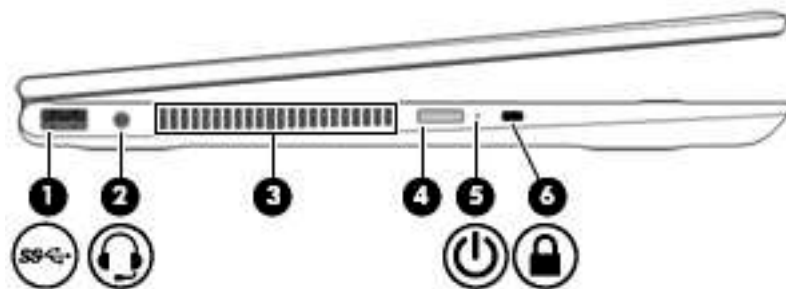

Component	Description
(1)  Drive light	<ul style="list-style-type: none">• Blinking white: The hard drive is being accessed.• Amber: HP 3D DriveGuard has temporarily parked the hard drive.
(2)  Fingerprint reader (select products only)	Allows a fingerprint logon to Windows, instead of a password logon.
(3)  Volume button (select products only)	Controls speaker volume on the computer.
(4)  Memory card reader	Reads optional memory cards that enable you to store, manage, share, or access information. To insert a card: <ol style="list-style-type: none">1. Hold the card label-side up, with connectors facing the computer.2. Insert the card into the memory card reader, and then press in on the card until it is firmly seated. To remove a card: <ul style="list-style-type: none">▲ Press in on the card, and then remove it from the memory card reader.
(5)  USB Type-C port	Connects a USB device, such as a cell phone, camera, activity tracker, or smartwatch, and provides data transfer. NOTE: Cables and/or adapters (purchased separately) may be required.
(6)  USB SuperSpeed port	Connects a USB device, such as a cell phone, camera, activity tracker, or smartwatch, and provides high-speed data transfer.
(7)  HDMI port	Connects an optional video or audio device, such as a high-definition television, any compatible digital or audio component, or a high-speed High-Definition Multimedia Interface (HDMI) device.

Component	Description
(8) AC adapter and battery light	<ul style="list-style-type: none"> White: The AC adapter is connected and the battery is fully charged. Blinking white: The AC adapter is disconnected and the battery has reached a low battery level. Amber: The AC adapter is connected and the battery is charging. Off: The battery is not charging.
(9) Power connector	Connects an AC adapter.

Left side



Component	Description
(1)  USB SuperSpeed port	Connects a USB device, such as a cell phone, camera, activity tracker, or smartwatch, and provides high-speed data transfer.
(2)  Audio-out (headphone)/Audio-in (microphone) combo jack	<p>Connects optional powered stereo speakers, headphones, earbuds, a headset, or a television audio cable. Also connects an optional headset microphone. This jack does not support optional standalone microphones.</p> <p>WARNING! To reduce the risk of personal injury, adjust the volume before putting on headphones, earbuds, or a headset. For additional safety information, see the <i>Regulatory, Safety, and Environmental Notices</i>.</p> <p>To access this guide:</p> <ul style="list-style-type: none"> ▲ Select the Start button, select HP Help and Support, and then select HP Documentation. <p>NOTE: When a device is connected to the jack, the computer speakers are disabled.</p>
(3) Vent	<p>Enables airflow to cool internal components.</p> <p>NOTE: The computer fan starts up automatically to cool internal components and prevent overheating. It is normal for the internal fan to cycle on and off during routine operation.</p>
(4) Power button	<ul style="list-style-type: none"> When the computer is off, press the button to turn on the computer. When the computer is on, press the button briefly to initiate Sleep. When the computer is in the Sleep state, press the button briefly to exit Sleep.

Component	Description
	<ul style="list-style-type: none"> When the computer is in Hibernation, press the button briefly to exit Hibernation. <p>CAUTION: Pressing and holding down the power button results in the loss of unsaved information.</p> <p>If the computer has stopped responding and shutdown procedures are ineffective, press and hold the power button for at least 5 seconds to turn off the computer.</p> <p>To learn more about your power settings, see your power options.</p> <ul style="list-style-type: none"> Right-click the Power meter icon  and then select Power Options.
(5) 	<p>Power light</p> <ul style="list-style-type: none"> On: The computer is on. Blinking: The computer is in the Sleep state, a power-saving state. The computer shuts off power to the display and other unneeded components. Off: The computer is off or in Hibernation. Hibernation is a power-saving state that uses the least amount of power.
(6) 	<p>Security cable slot</p> <p>Attaches an optional security cable to the computer.</p> <p>NOTE: The security cable is designed to act as a deterrent, but it may not prevent the computer from being mishandled or stolen.</p>

Display

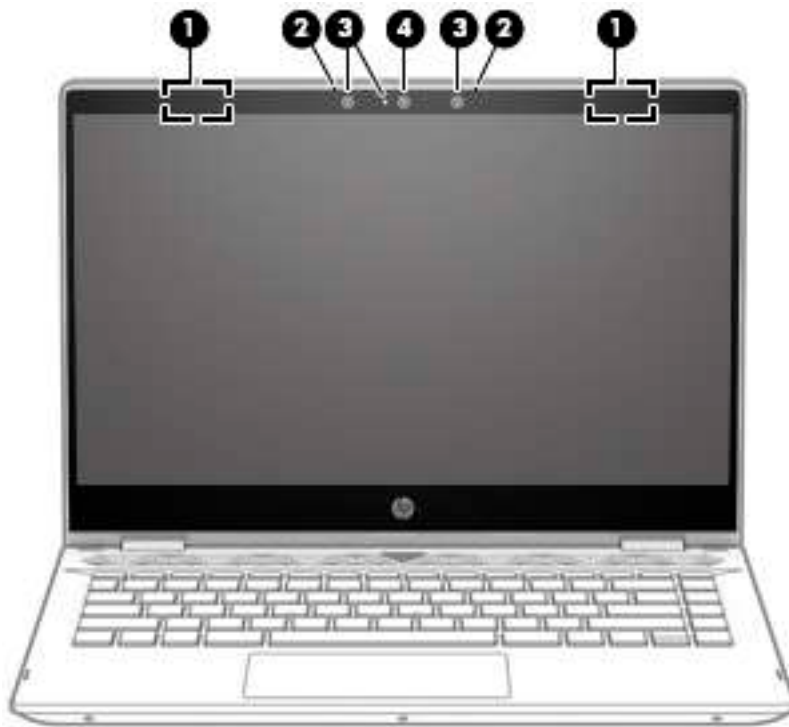

Component	Description
(1) WLAN antennas*	Send and receive wireless signals to communicate with wireless local area networks (WLANs).
(2) Internal microphones	Record sound.
(3) Camera light(s)	On: One or more cameras are in use.
(4) Camera	Allows you to video chat, record video, and record still images. Some cameras also allow a facial recognition logon to Windows, instead of a password logon. NOTE: Camera functions vary depending on the camera hardware and software installed on your product.

*The antennas are not visible from the outside of the computer. For optimal transmission, keep the areas immediately around the antennas free from obstructions.

For wireless regulatory notices, see the section of the *Regulatory, Safety, and Environmental Notices* that applies to your country or region.

To access this guide:

1. Type `support` in the taskbar search box, and then select the **HP Support Assistant** app.
– or –
Click the question mark icon in the taskbar.
2. Select **My PC**, select the **Specifications** tab, and then select **User Guides**.

Keyboard area

TouchPad

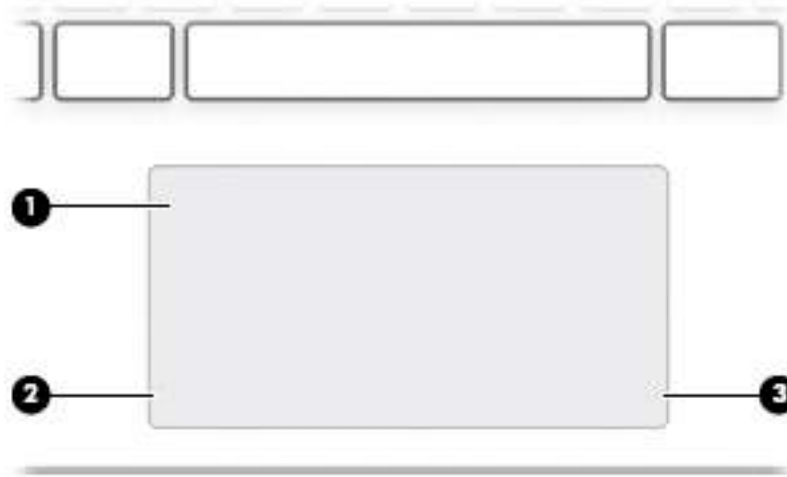

Component		Description
(1)	TouchPad zone	Reads your finger gestures to move the pointer or activate items on the screen.
(2)	Left TouchPad button	Functions like the left button on an external mouse.
(3)	Right TouchPad button	Functions like the right button on an external mouse.

Lights

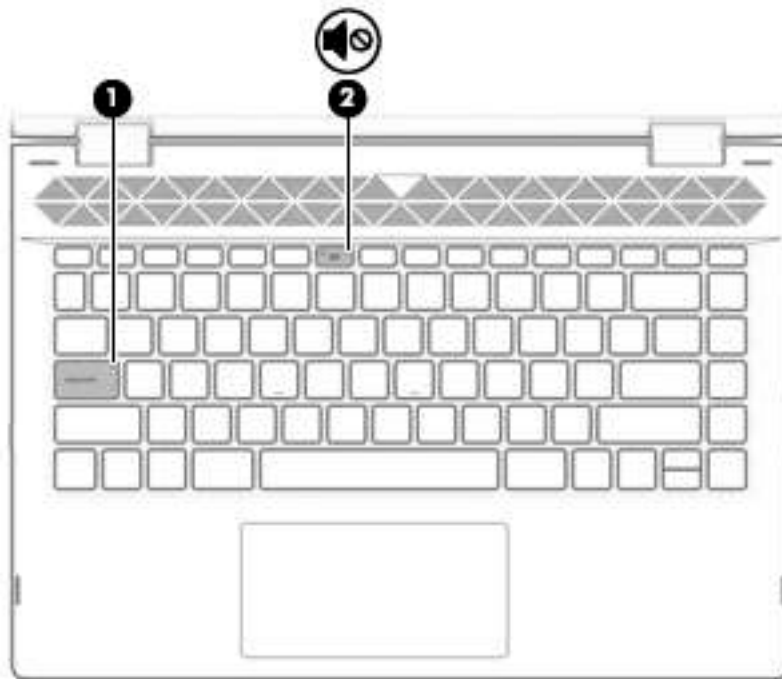

Component	Description
(1) Caps lock light	On: Caps lock is on, which switches the key input to all capital letters.
(2)  Mute light	<ul style="list-style-type: none">• On: Computer sound is off.• Off: Computer sound is on.

Speakers and camera

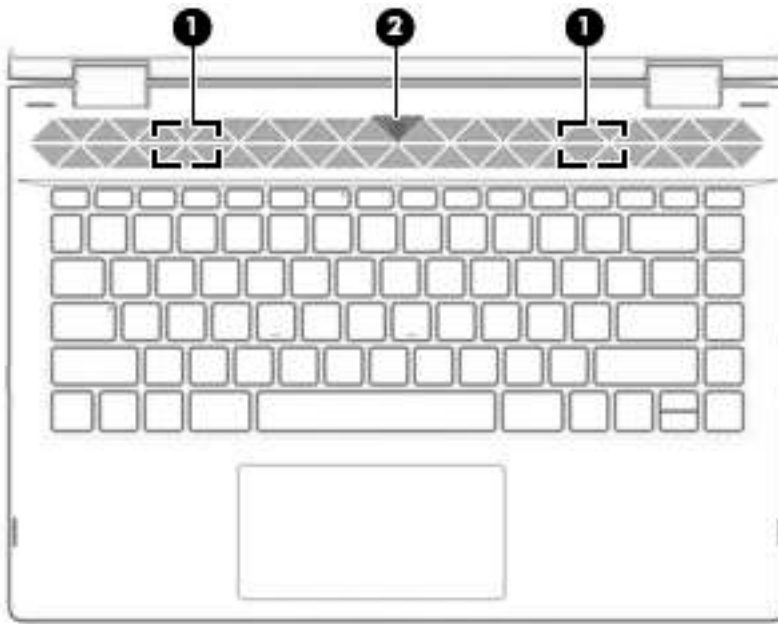

Component	Description
(1) Speakers	Produce sound.
(2) Camera (select products only)	Allows you to video chat, record video, and record still images. Some cameras also allow a facial recognition logon to Windows, instead of a password logon. NOTE: Camera functions vary depending on the camera hardware and software installed on your product.

Special keys

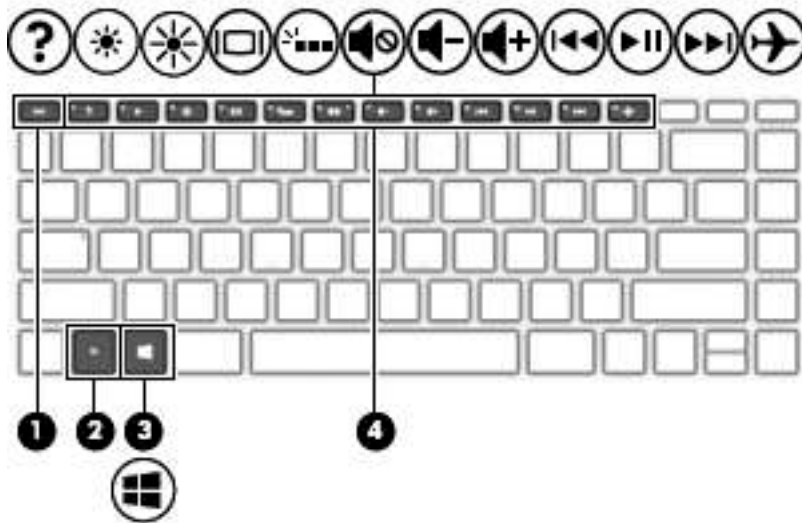















Component	Description
(1) esc key	Displays system information when pressed in combination with the fn key.
(2) fn key	Executes specific functions when pressed in combination with another key.
(3)  Windows key	Opens the Start menu. NOTE: Pressing the Windows key again will close the Start menu.
(4) Action keys	Execute frequently used system functions. NOTE: On select products, the f5 action key turns the keyboard backlight feature off or on.

Action keys

An action key performs the function indicated by the icon on the key. To determine which keys are on your product, see [Special keys on page 13](#).

▲ To use an action key, press and hold the key.

Icon	Description
	Helps prevent side-angle viewing from onlookers. If needed, decrease or increase brightness for well-lit or darker environments. Press the key again to turn off the privacy screen.
	
	Decreases the screen brightness incrementally as long as you hold down the key.
	Increases the screen brightness incrementally as long as you hold down the key.
	Opens the "How to get help in Windows 10" webpage.
	Switches the screen image between display devices connected to the system. For example, if a monitor is connected to the computer, repeatedly pressing this key alternates the screen image from the computer display to the monitor display to a simultaneous display on both the computer and the monitor.
	Turns the keyboard backlight off or on (select products only). NOTE: To conserve battery power, turn off this feature.
	Plays the previous track of an audio CD or the previous section of a DVD or a Blu-ray Disc (BD).
	Starts, pauses, or resumes playback of an audio CD, a DVD, or a BD.
	Plays the next track of an audio CD or the next section of a DVD or a BD.
	Stops audio or video playback of a CD, a DVD, or a BD.
	Decreases speaker volume incrementally while you hold down the key.
	Increases speaker volume incrementally while you hold down the key.
	Mutes or restores speaker sound.
	Turns the airplane mode and wireless feature on or off. NOTE: The airplane mode key is also referred to as the wireless button. NOTE: A wireless network must be set up before a wireless connection is possible.

Bottom

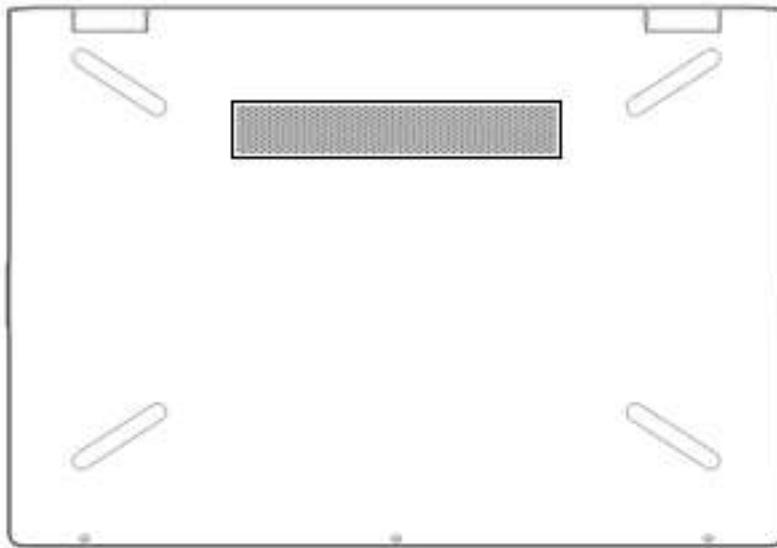

Component	Description
Vent	Enables airflow to cool internal components. NOTE: The computer fan starts up automatically to cool internal components and prevent overheating. It is normal for the internal fan to cycle on and off during routine operation.

Labels

The labels affixed to the computer provide information you may need when you troubleshoot system problems or travel internationally with the computer. Labels may be in paper form or imprinted on the product.

 **IMPORTANT:** Check the following locations for the labels described in this section: the bottom of the computer, inside the battery bay, under the service door, on the back of the display, or on the bottom of a tablet kickstand.

- Service label—Provides important information to identify your computer. When contacting support, you may be asked for the serial number, the product number, or the model number. Locate this information before you contact support.

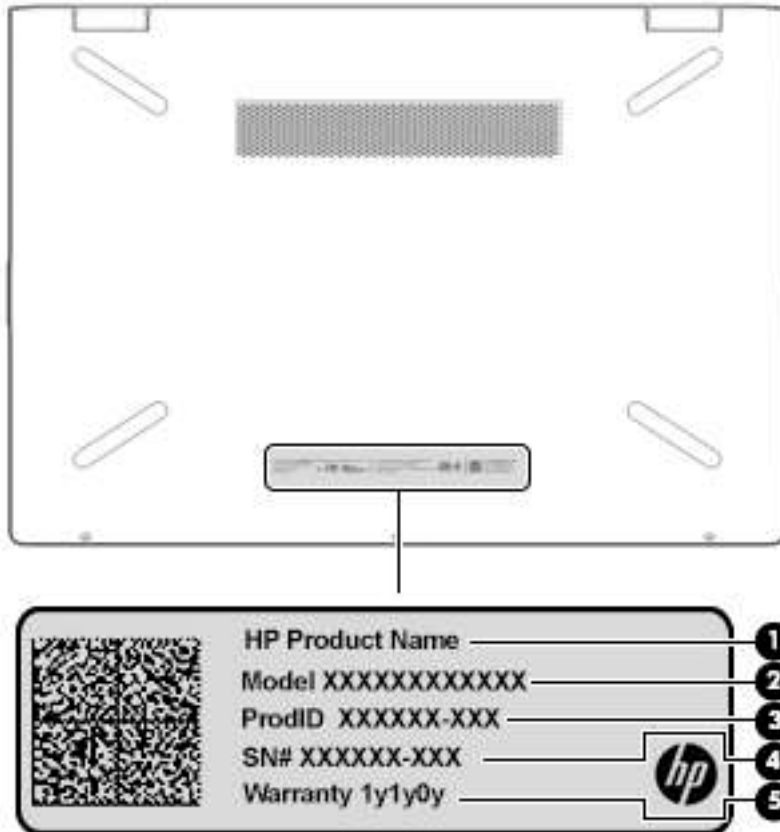

Component	
(1)	Product name
(2)	Model number
(3)	Product ID
(4)	Serial number
(5)	Warranty period

- Regulatory label(s)—Provide(s) regulatory information about the computer.
- Wireless certification label(s)—Provide(s) information about optional wireless devices and the approval markings for the countries or regions in which the devices have been approved for use.

3 Illustrated parts catalog

 **NOTE:** HP continually improves and changes product parts. For complete and current information on supported parts for your computer, go to <http://partsurfer.hp.com>, select your country or region, and then follow the on-screen instructions.

Computer major components

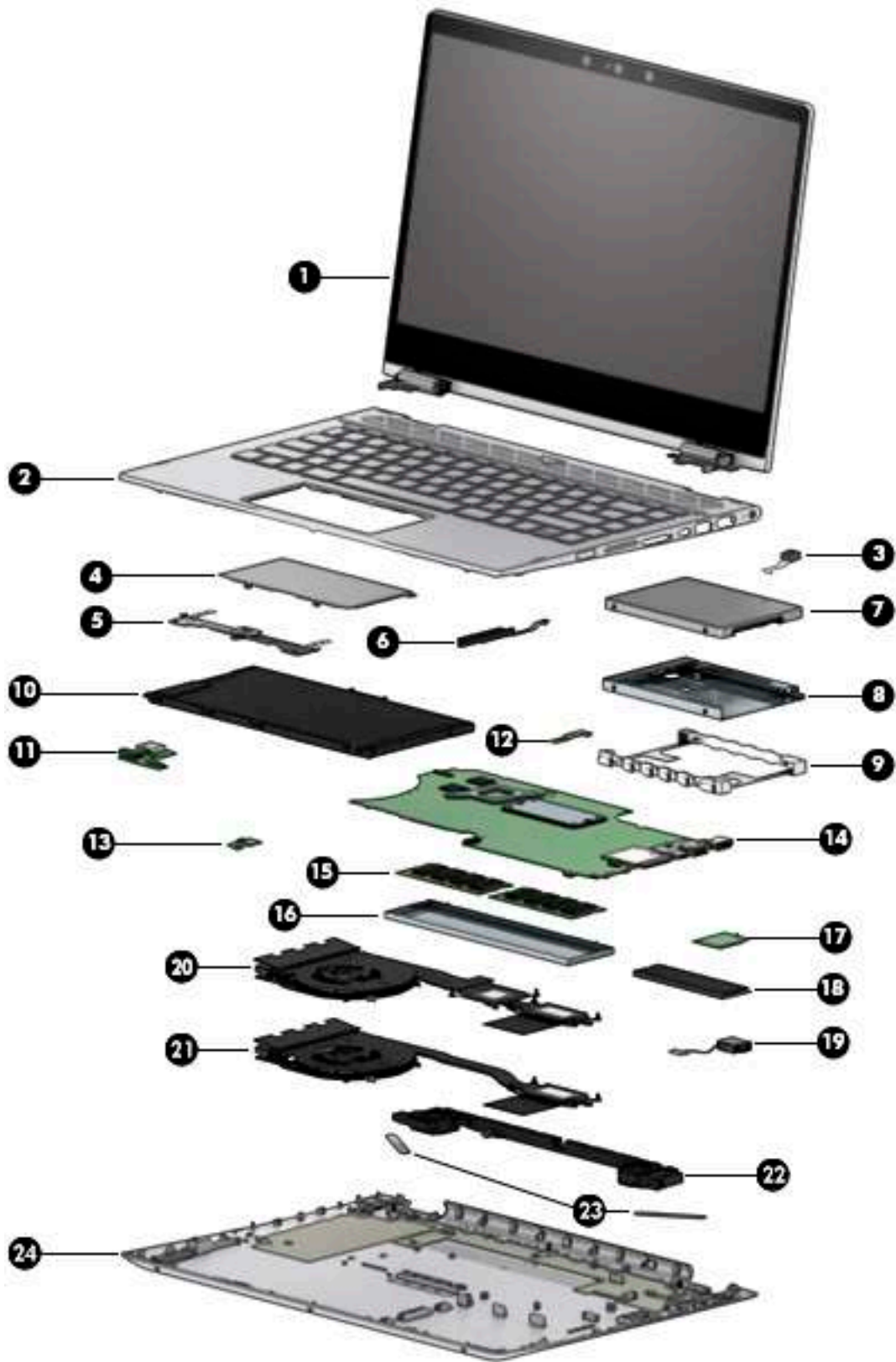

Item	Component	Spare part number
(1)	Display assembly IMPORTANT: The display assembly is spared only as an entire hinge-up. Display subcomponents are not spared.	
	FHD, BrightView, HD camera, mineral silver	L18192-001
	FHD panel, BrightView, IR camera, natural silver	L20551-001
	FHD panel, BrightView, HD camera, natural silver	L20552-001
	HD panel, anti glare, HD camera, natural silver	L20553-001
	FHD panel, BrightView, IR camera, pale gold	L20554-001
	FHD panel, BrightView, HD camera, pale gold	L20555-001
	HD panel, anti glare, HD camera, pale gold	L20556-001
	FHD panel, BrightView, IR camera, sapphire blue	L20557-001
	FHD panel, BrightView, HD camera, sapphire blue	L20558-001
	HD panel, anti glare, HD camera, sapphire blue	L20559-001
(2)	Top cover with keyboard	
	Backlit, full-featured models, natural silver	L18946-001
	No backlight, full-featured models, natural silver	L18947-001
	Backlit, full-featured models, pale gold	L18948-001
	No backlight, full-featured models, pale gold	L18949-001
	Backlit, full-featured models, sapphire blue	L18950-001
	No backlight, full-featured models, sapphire blue	L18951-001
	No backlight, full-featured models+	L18952-001
	Backlit, full-featured models+	L18953-001
	No backlight, full-featured models+, MIPI	L18954-001
	Backlit, full-featured models+, MIPI	L18955-001
(3)	Camera, world-facing	L18181-001
(4)	TouchPad (includes Mylar and bracket rubber) NOTE: The TouchPad cable is available using spare part number L18215-001.	
	Full-featured models	L18211-001
	Full-featured plus models	L18212-001
(5)	TouchPad bracket (available in the Miscellaneous Parts Kit)	L20548-001
(6)	Hard drive cable	L18218-001
(7)	Hard drive (7 mm):	
	1-TB, 5400-rpm, SATA, 8-GB hybrid hard drive	924036-855
	1-TB, 5400-rpm, SATA hard drive	762990-005

Item	Component	Spare part number
	500-GB, 5400-rpm, SATA hard drive	778186-005
(8)	Hard drive foil	L20549-001
(9)	Hard drive rubber gasket	
	Full-featured models	L18225-001
	Full-featured plus models	L18226-001
(10)	Battery (3-cell, 41-WHr, 3.6-AHr, Li-ion)	920070-856
(11)	USB/audio board	
	NOTE: The USB/audio board cable is available using spare part number L20816-001.	
	Full-featured models	L18204-001, L36458-001
	Full-featured plus models	L18205-001, L36459-001
(12)	Power button board	L18206-001
	NOTE: The power button board cable is available using spare part number L18217-001.	
(13)	Fingerprint reader board , for use only in full-featured models	L18208-001
	NOTE: The fingerprint reader board cable is available using spare part number L18219-001.	
	Fingerprint reader module , for use only in full-featured plus models	L18210-001
	Fingerprint bracket (included in the Miscellaneous Parts Kit)	L20548-001
(14)	System board (includes processor and replacement thermal material):	
	All system boards use the following part numbers:	
	xxxxxx-001: Non-Windows operating systems	
	xxxxxx-601: Windows operating system	
	Models with discrete graphics:	
	<ul style="list-style-type: none"> Intel Core i7-8565U processor and 4 GB of discrete graphics memory 	L36453-xx1
	<ul style="list-style-type: none"> Intel Core i7-8550U processor and 4 GB of discrete graphics memory for use in models with an HD camera 	L18159-xx1
	<ul style="list-style-type: none"> Intel Core i7-8550U processor and 4 GB of discrete graphics memory for use in models with an IR camera 	L18171-xx1
	<ul style="list-style-type: none"> Intel Core i5-8265U processor and 2 GB of discrete graphics memory 	L36452-xx1
	<ul style="list-style-type: none"> Intel Core i5-8250U processor and 2 GB of discrete graphics memory 	L18157-xx1
	<ul style="list-style-type: none"> Intel Core i3-8145U processor and 2 GB of discrete graphics memory 	L36451-xx1
	<ul style="list-style-type: none"> Intel Core i3-8130U processor and 2 GB of discrete graphics memory 	L18173-xx1
	Models with UMA graphics:	
	<ul style="list-style-type: none"> Intel Core i5-8250U processor and an HD camera 	L18163-xx1
	<ul style="list-style-type: none"> Intel Core i5-8250U processor and an IR camera 	L18165-xx1
	<ul style="list-style-type: none"> Intel Core i5-8250U processor, HD camera, and world-facing camera 	L18167-xx1

Item	Component	Spare part number
	<ul style="list-style-type: none"> Intel Core i5-8265U processor 	L36455-xx1
	<ul style="list-style-type: none"> Intel Core i3-8145U processor 	L36454-xx1
	<ul style="list-style-type: none"> Intel Core i3-8130U processor 	L18175-xx1
	<ul style="list-style-type: none"> Intel Core i3-8130U processor, HD camera, and world-facing camera 	L18177-xx1
	<ul style="list-style-type: none"> Intel Core i3-7100U processor 	L43724-xx1
	<ul style="list-style-type: none"> Intel Pentium 4415U processor 	L18169-xx1
	Thermal pad for use in models with discrete graphics (not illustrated)	L21302-001
(15)	Memory modules (DDR4-2400):	
	8-MB	862398-855
	4-MB	862397-855
	2-MB	864271-855
(16)	Memory cover (included in Miscellaneous Parts Kit)	L20548-001
(17)	WLAN module:	
	Intel Dual Band Wireless-AC 7265 802.11 AC 2x2 WiFi + Bluetooth 4.2 Combo Adapter (non-vPro)	901229-855
	Intel Dual Band Wireless-AC 3168 802.11 AC 1x1 WiFi + Bluetooth 4.2 Combo Adapter (non-vPro)	863934-855
	Realtek RTL8822BE 802.11 ac 2x2 WiFi + Bluetooth 4.2 Combo Adapter (MU-MIMO supported)	924813-855
	Realtek RTL8821CE 802.11 ac 1x1 WiFi + Bluetooth 4.2 Combo Adapter (MU-MIMO supported)	L17365-005
(18)	Solid-state drive (M.2; includes foil)	
	512-GB, PCIe, NVMe	L18198-001
	256-GB, 2280, PCIe, NVMe	L18196-001
	256-GB, SATA-3, TLC	L18195-001
	128-GB, 2280, PCIe, 3x2 TLC	L33599-001
	128-GB, SATA-3, TLC	L18194-001
	Optane memory module (16-GB; not illustrated)	L18197-001
(19)	Power connector cable	L18220-001
	Fan/heat sink assembly (includes fan cable and replacement thermal material):	
(20)	For use in models equipped with a discrete graphics memory subsystem	L18221-001, L36456-001
(21)	For use in models equipped with a UMA graphics subsystem	L18222-001, L36457-001
(22)	Speakers (include cable)	L18227-001
(23)	Rubber Feet Kit (includes rubber feet and Mylar screw cover)	
	Full-featured models	L18223-001
	Full-featured plus models	L18224-001

Item	Component	Spare part number
(24)	Base enclosure	
	Full-featured, natural silver models	L18189-001
	Full-featured plus models	L18190-001
	Full-featured, pale gold models	L18926-001
	Full-featured, sapphire blue models	L18927-001

Cables

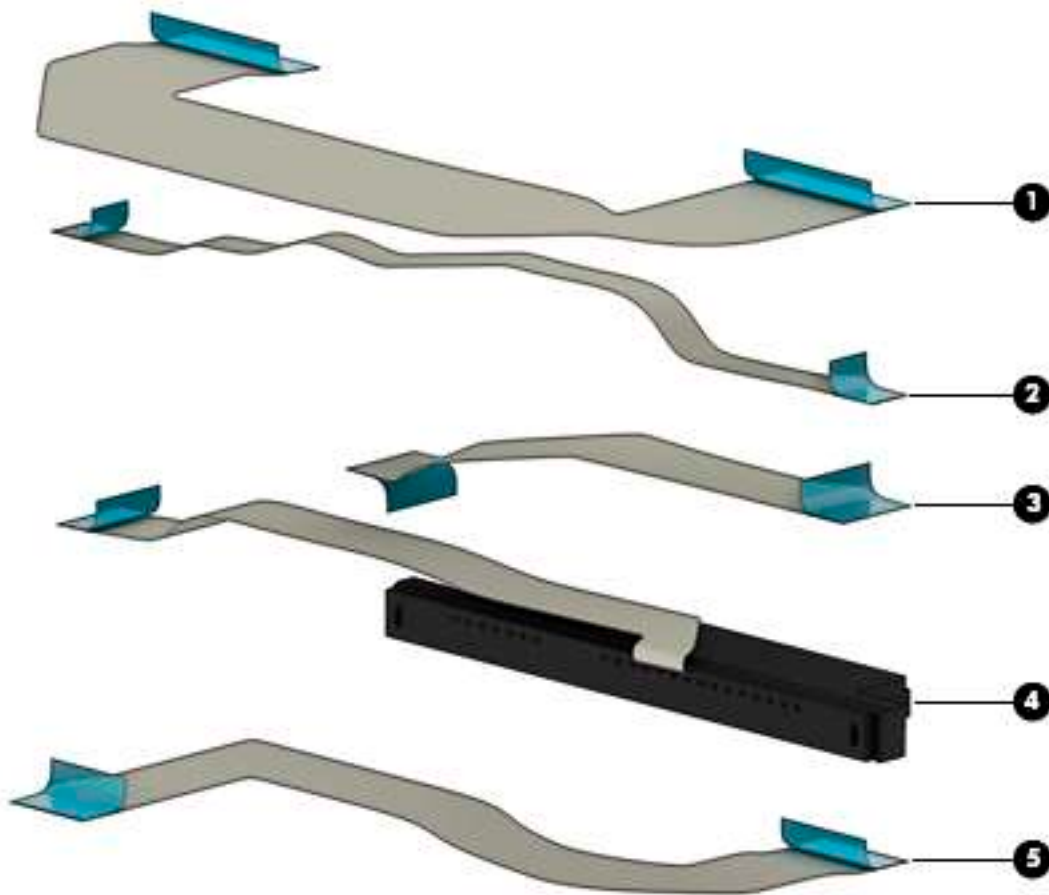

Item	Component	Spare part number
(1)	USB/audio board cable	L18216-001
(2)	Power button board cable	L18217-001
(3)	TouchPad module cable	L18215-001
(4)	Hard drive cable	L18218-001
(5)	Fingerprint reader board cable	L18219-001

Mass storage devices

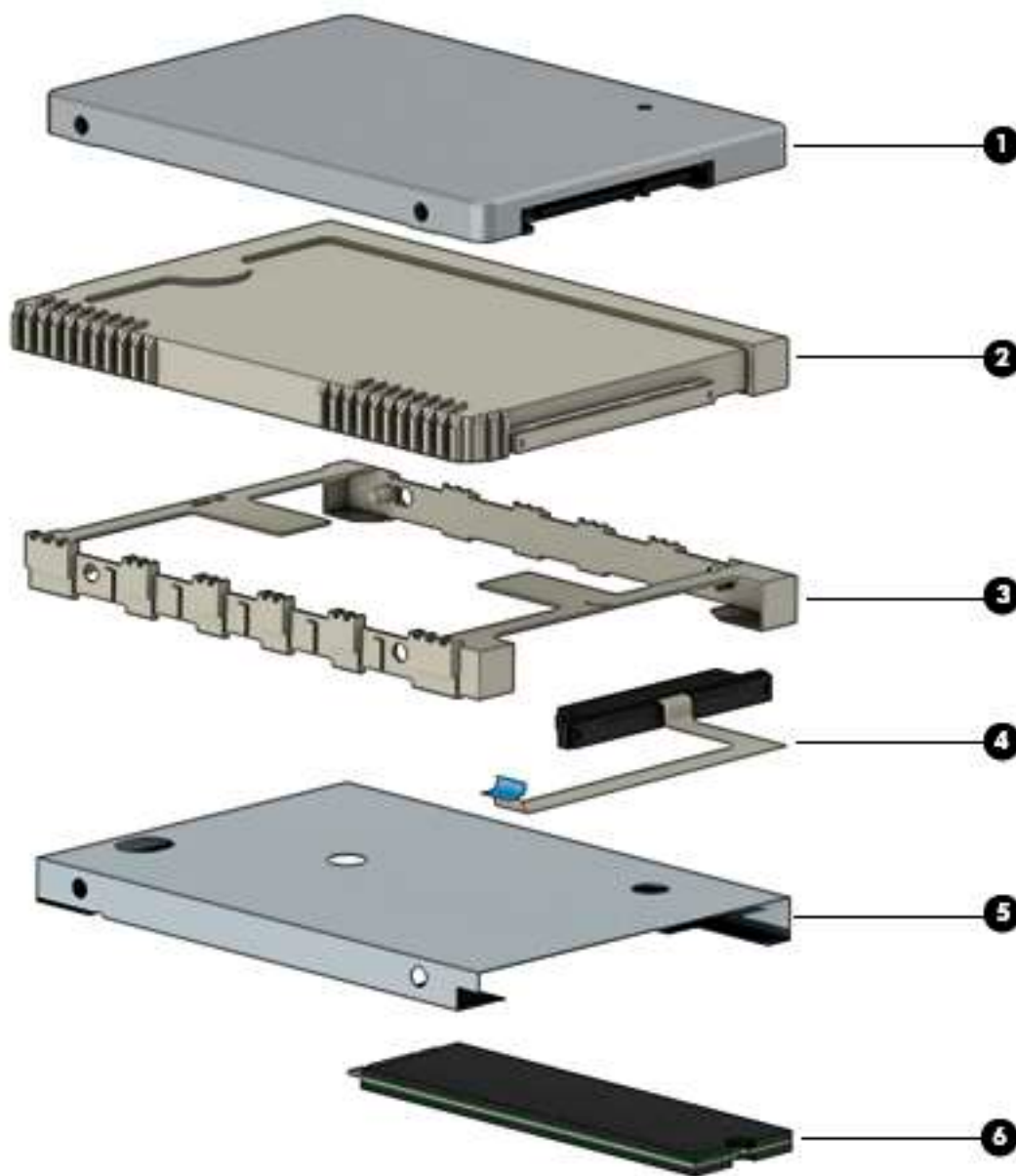

Item	Component	Spare part number
(1)	Hard drive	
	1-TB, 5400-rpm, SATA, 8-GB hybrid hard drive	924036-855
	1-TB, 5400-rpm, SATA hard drive	762990-005
	500-GB, 5400-rpm, SATA hard drive	778186-005
(2)	Hard drive rubber insert (for use in models without a hard drive)	L20550-001
(3)	Hard drive rubber sleeve	
	Full-featured models	L18225-001

Item	Component	Spare part number
	Full-featured plus models	L18226-001
(4)	Hard drive cable	L18218-001
(5)	Hard drive foil	L20549-001
	Rubber hard drive insert (for use in models without a hard drive)	L20550-001
(6)	Solid-state drives (M.2; includes foil)	
	512-GB, PCIe, NVMe	L18198-001
	256-GB, 2280, PCIe, NVMe	L18196-001
	256-GB, SATA-3, TLC	L18195-001
	128-GB, 2280, PCIe 3x2 TLC	L33599-001
	128-GB, SATA-3, TLC	L18194-001
	Optane memory module (16-GB)	L18197-001

Miscellaneous Parts Kit

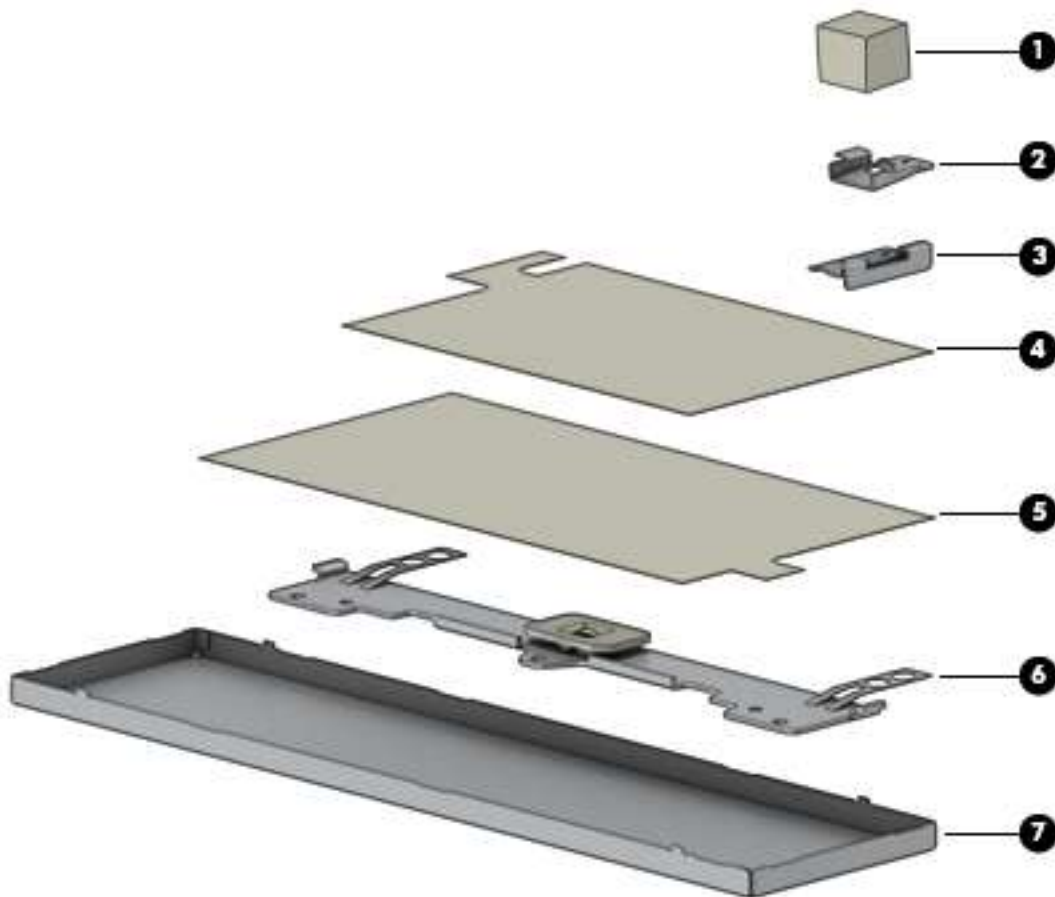

Item	Component	Spare part number
	Miscellaneous parts kit	L20548-001
(1)	Camera gasket (not illustrated)	
(2)	MIPI camera bracket	
(3)	Fingerprint reader bracket	
(4)	Battery Mylar	
(5)	Hard drive Mylar	
(6)	TouchPad bracket	
(7)	Memory cover	
	Power button board sponge (not illustrated)	
	Memory module absorber (not illustrated)	

Miscellaneous parts

Component	Spare part number
AC adapter:	
65-W HP Smart AC adapter (non-PFC, EM, RC, 4.5-mm)	913691-850
65-W AC adapter (non-PFC, S-3P, 4.5-mm)	710412-001
65-W AC adapter (non-PFC, 4.5-mm, for use in Argentina)	710340-850
45-W HP Smart AC adapter (non-PFC, RC, 4.5-mm, non-slim, for use in Argentina)	741553-852
45-W HP Smart AC adapter (non-PFC, 4.5-mm, non-slim)	741727-001
HP HDMI-to-VGA adapter	701943-001
HP external DVD±RW DL SuperMulti Drive	747080-001
HP USB to Gigabit RJ-45 adapter	829941-001
HP USB-C to USB-A dongle	833960-001
Power cord (C5 connector, 1.00-m):	
For use in Argentina	L19357-001
For use in Australia	L19358-001
For use in Denmark	L19360-001
For use in Europe	L19361-001
For use in India	L19363-001
For use in Israel	L19362-001
For use in Italy	L19364-001
For use in Japan	L19365-001
For use in North America	L19367-001
For use in the People's Republic of China	L19368-001
For use in South Africa	L19369-001
For use in Switzerland	L19370-001
For use in Taiwan	L19372-001
For use in Thailand	L19371-001
For use in the United Kingdom and Singapore	L19373-001
Screw Kit	L18228-001
Pen tip	L04536-001
Stylus (active pen in Pike silver finish)	910942-001

4 Removal and replacement preliminary requirements

Tools required

You will need the following tools to complete the removal and replacement procedures:

- Flat-bladed screw driver
- Magnetic screw driver
- Phillips P0 screw driver

Service considerations

The following sections include some of the considerations that you must keep in mind during disassembly and assembly procedures.

 **NOTE:** As you remove each subassembly from the computer, place the subassembly (and all accompanying screws) away from the work area to prevent damage.

Plastic parts

 **CAUTION:** Using excessive force during disassembly and reassembly can damage plastic parts. Use care when handling the plastic parts. Apply pressure only at the points designated in the maintenance instructions.

Cables and connectors

 **CAUTION:** When servicing the computer, be sure that cables are placed in their proper locations during the reassembly process. Improper cable placement can damage the computer.

Cables must be handled with extreme care to avoid damage. Apply only the tension required to unseat or seat the cables during removal and insertion. Handle cables by the connector whenever possible. In all cases, avoid bending, twisting, or tearing cables. Be sure that cables are routed in such a way that they cannot be caught or snagged by parts being removed or replaced. Handle flex cables with extreme care; these cables tear easily.

Drive handling

⚠ CAUTION: Drives are fragile components that must be handled with care. To prevent damage to the computer, damage to a drive, or loss of information, observe these precautions:

Before removing or inserting a drive, shut down the computer. If you are unsure whether the computer is off or in Hibernation, turn the computer on, and then shut it down through the operating system.

Before handling a drive, be sure that you are discharged of static electricity. While handling a drive, avoid touching the connector.

Before removing a diskette drive or optical drive, be sure that a diskette or disc is not in the drive and be sure that the optical drive tray is closed.

Handle drives on surfaces covered with at least one inch of shock-proof foam.

Avoid dropping drives from any height onto any surface.

After removing drive, place it in a static-proof bag.

Avoid exposing a drive to products that have magnetic fields, such as monitors or speakers.

Avoid exposing a drive to temperature extremes or liquids.

If a drive must be mailed, place the drive in a bubble pack mailer or other suitable form of protective packaging and label the package "FRAGILE."

Grounding guidelines

Electrostatic discharge damage

Electronic components are sensitive to electrostatic discharge (ESD). Circuitry design and structure determine the degree of sensitivity. Networks built into many integrated circuits provide some protection, but in many cases, ESD contains enough power to alter device parameters or melt silicon junctions.

A discharge of static electricity from a finger or other conductor can destroy static-sensitive devices or microcircuitry. Even if the spark is neither felt nor heard, damage may have occurred.

An electronic device exposed to ESD may not be affected at all and can work perfectly throughout a normal cycle. Or the device may function normally for a while, then degrade in the internal layers, reducing its life expectancy.

CAUTION: To prevent damage to the computer when you are removing or installing internal components, observe these precautions:

Keep components in their electrostatic-safe containers until you are ready to install them.

Before touching an electronic component, discharge static electricity by using the guidelines described in this section.

Avoid touching pins, leads, and circuitry. Handle electronic components as little as possible.

If you remove a component, place it in an electrostatic-safe container.

The following table shows how humidity affects the electrostatic voltage levels generated by different activities.

CAUTION: A product can be degraded by as little as 700 V.

Typical electrostatic voltage levels			
Event	Relative humidity		
	10%	40%	55%
Walking across carpet	35,000 V	15,000 V	7,500 V
Walking across vinyl floor	12,000 V	5,000 V	3,000 V
Motions of bench worker	6,000 V	800 V	400 V
Removing DIPS from plastic tube	2,000 V	700 V	400 V
Removing DIPS from vinyl tray	11,500 V	4,000 V	2,000 V
Removing DIPS from Styrofoam	14,500 V	5,000 V	3,500 V
Removing bubble pack from PCB	26,500 V	20,000 V	7,000 V
Packing PCBs in foam-lined box	21,000 V	11,000 V	5,000 V

Packaging and transporting guidelines

Follow these grounding guidelines when packaging and transporting equipment:

- To avoid hand contact, transport products in static-safe tubes, bags, or boxes.
- Protect ESD-sensitive parts and assemblies with conductive or approved containers or packaging.
- Keep ESD-sensitive parts in their containers until the parts arrive at static-free workstations.
- Place items on a grounded surface before removing items from their containers.
- Always be properly grounded when touching a component or assembly.
- Store reusable ESD-sensitive parts from assemblies in protective packaging or nonconductive foam.
- Use transporters and conveyors made of antistatic belts and roller bushings. Be sure that mechanized equipment used for moving materials is wired to ground and that proper materials are selected to avoid static charging. When grounding is not possible, use an ionizer to dissipate electric charges.

Workstation guidelines

Follow these grounding workstation guidelines:

- Cover the workstation with approved static-shielding material.
- Use a wrist strap connected to a properly grounded work surface and use properly grounded tools and equipment.
- Use conductive field service tools, such as cutters, screw drivers, and vacuums.
- When fixtures must directly contact dissipative surfaces, use fixtures made only of static-safe materials.
- Keep the work area free of nonconductive materials, such as ordinary plastic assembly aids and Styrofoam.
- Handle ESD-sensitive components, parts, and assemblies by the case or PCM laminate. Handle these items only at static-free workstations.
- Avoid contact with pins, leads, or circuitry.
- Turn off power and input signals before inserting or removing connectors or test equipment.

Equipment guidelines

Grounding equipment must include either a wrist strap or a foot strap at a grounded workstation.

- When seated, wear a wrist strap connected to a grounded system. Wrist straps are flexible straps with a minimum of one megohm $\pm 10\%$ resistance in the ground cords. To provide proper ground, wear a strap snugly against the skin at all times. On grounded mats with banana-plug connectors, use alligator clips to connect a wrist strap.
- When standing, use foot straps and a grounded floor mat. Foot straps (heel, toe, or boot straps) can be used at standing workstations and are compatible with most types of shoes or boots. On conductive floors or dissipative floor mats, use foot straps on both feet with a minimum of one megohm resistance between the operator and ground. To be effective, the conductive must be worn in contact with the skin.

The following grounding equipment is recommended to prevent electrostatic damage:

- Antistatic tape
- Antistatic smocks, aprons, and sleeve protectors
- Conductive bins and other assembly or soldering aids
- Nonconductive foam
- Conductive computerop workstations with ground cords of one megohm resistance
- Static-dissipative tables or floor mats with hard ties to the ground
- Field service kits
- Static awareness labels
- Material-handling packages
- Nonconductive plastic bags, tubes, or boxes
- Metal tote boxes
- Electrostatic voltage levels and protective materials

The following table lists the shielding protection provided by antistatic bags and floor mats.

Material	Use	Voltage protection level
Antistatic plastics	Bags	1,500 V
Carbon-loaded plastic	Floor mats	7,500 V
Metallized laminate	Floor mats	5,000 V

5 Removal and replacement procedures

This chapter provides removal and replacement procedures for Authorized Service Provider only parts.

 **CAUTION:** Components described in this chapter should only be accessed by an authorized service provider. Accessing these parts can damage the computer or void the warranty.

CAUTION: This computer does not have user-replaceable parts. Only HP authorized service providers should perform the removal and replacement procedures described here. Accessing the internal part could damage the computer or void the warranty.

Component replacement procedures

 **NOTE:** Details about your computer, including model, serial number, product key, and length of warranty, are on the service tag at the bottom of your computer. See [Labels on page 16](#) for details.

 **NOTE:** HP continually improves and changes product parts. For complete and current information on supported parts for your computer, go to <http://partsurfer.hp.com>, select your country or region, and then follow the on-screen instructions.

There are as many as 46 screws that must be removed, replaced, and/or loosened when servicing Authorized Service Provider only parts. Make special note of each screw size and location during removal and replacement.

Bottom cover

Description	Spare part number
Bottom cover	L09577-001
Rubber Feet Kit for use in full-featured models (includes rubber feet and Mylar screw cover)	L18223-001
Rubber Feet Kit for use in full-featured plus models (includes rubber feet and Mylar screw cover)	L18224-001

Before removing the bottom cover, follow these steps:

1. Turn off the computer. If you are unsure whether the computer is off or in Hibernation, turn the computer on, and then shut it down through the operating system.
2. Disconnect the power from the computer by unplugging the power cord from the computer.
3. Disconnect all external devices from the computer.

Remove the bottom cover:

1. Remove the two rubber feet near the vent (1).
2. Remove the two Phillips M2.0×6.0 screws (2) from under the feet.
3. Remove the Mylar screw cover (3).
4. Remove the four Phillips M2.0×4.0 screws (4) that secure the cover to the computer.

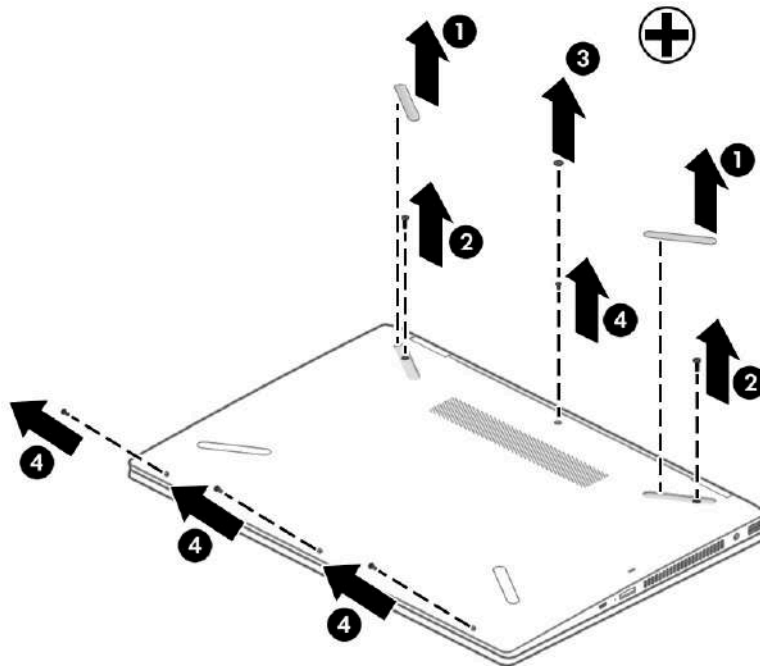

5. Starting near the display, use a plastic tool to pry the bottom cover up to remove it (2).

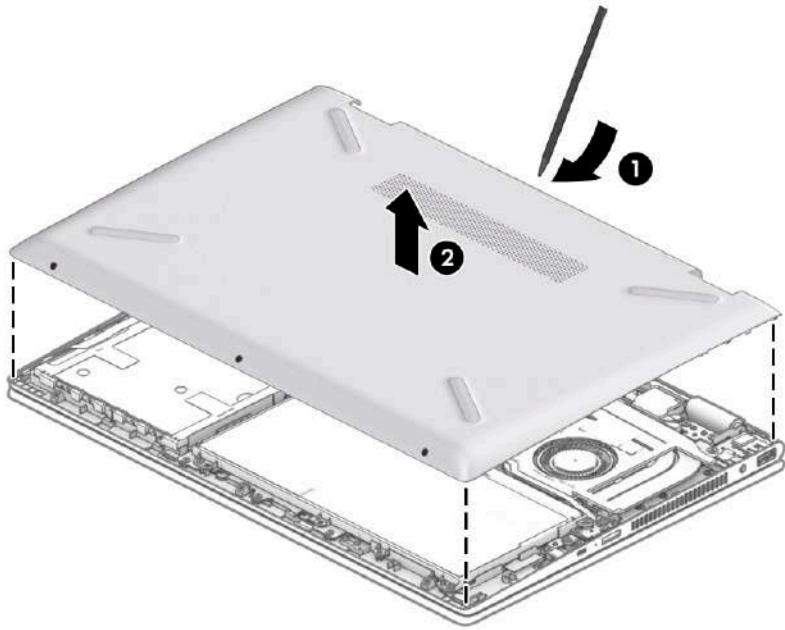

Battery

Description	Spare part number
3-cell, 41-WHr, 3.6-AHr, Li-ion battery	920070-856

Before removing the battery, follow these steps:

1. Shut down the computer. If you are unsure whether the computer is off or in Hibernation, turn the computer on, and then shut it down through the operating system.
2. Disconnect all external devices connected to the computer.
3. Disconnect the power from the computer by first unplugging the power cord from the AC outlet, and then unplugging the AC adapter from the computer.
4. Remove the bottom cover (see [Bottom cover on page 33](#)).

Remove the battery:

1. Remove the six Phillips M2.0×3.0 screws (1) that secure the battery to the computer.
2. Lift the battery on the connector side, and then remove it from the computer (2).

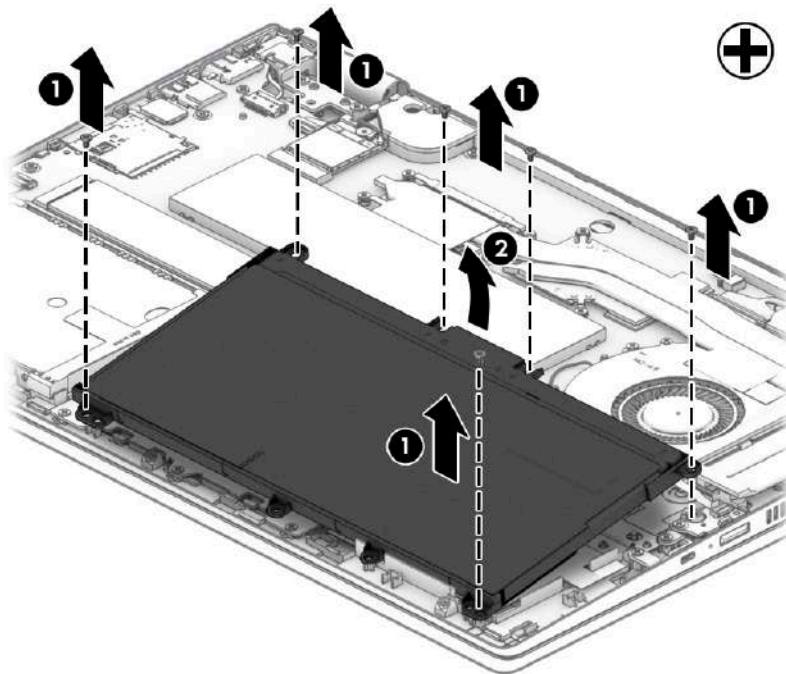

Reverse this procedure to install the battery.

Solid-state drive

 **IMPORTANT:** The solid-state drive is installed into the M.2 connector that is used by the Optane memory module. You cannot install both a solid-state drive and a Optane memory module in the computer at the same time.

Description	Spare part number
512-GB, PCIe, NVMe	L18198-001
256-GB, 2280, PCIe, NVMe	L18196-001
256-GB, SATA-3, TLC	L18195-001
128-GB, 2280, PCIe 3x2 TLC	L33599-001
128-GB, SATA-3, TLC	L18194-001

Before removing the solid-state drive, follow these steps:

1. Shut down the computer.
2. Disconnect all external devices connected to the computer.
3. Disconnect the power from the computer by first unplugging the power cord from the AC outlet and then unplugging the AC adapter from the computer.
4. Remove the bottom cover (see [Bottom cover on page 33](#)).
5. Remove the battery (see [Battery on page 35](#)).

Remove the solid-state drive:

1. Remove the aluminum foil covering the solid-state drive (1).
2. Remove the Phillips M2.0×3.0 screw (2), and then pull the solid-state drive module from the socket (3).

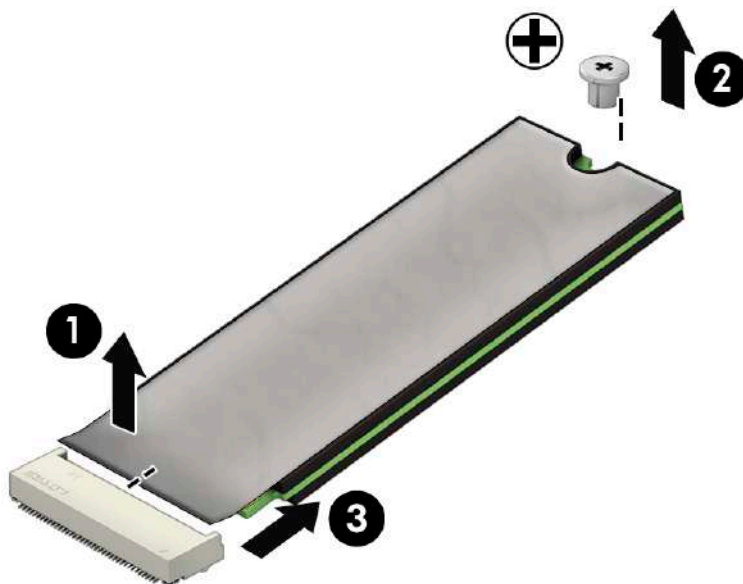

Reverse this procedure to install the solid-state drive.

Optane memory module

 **IMPORTANT:** The Optane memory module is installed into the M.2 connector that is used by M.2 solid-state drives. You cannot install both an Optane memory module and a solid-state drive in the computer at the same time.

Description	Spare part number
Optane memory module, 16 GB	L18197-001

Before removing the Optane memory module, follow these steps:

1. Shut down the computer.
2. Disconnect all external devices connected to the computer.
3. Disconnect the power from the computer by first unplugging the power cord from the AC outlet and then unplugging the AC adapter from the computer.
4. Remove the bottom cover (see [Bottom cover on page 33](#)).
5. Remove the battery (see [Battery on page 35](#)).

Remove the Optane memory module:

- ▲ Remove the Phillips M2.0×3.0 screw (1), and then pull the solid-state drive module from the socket (2).

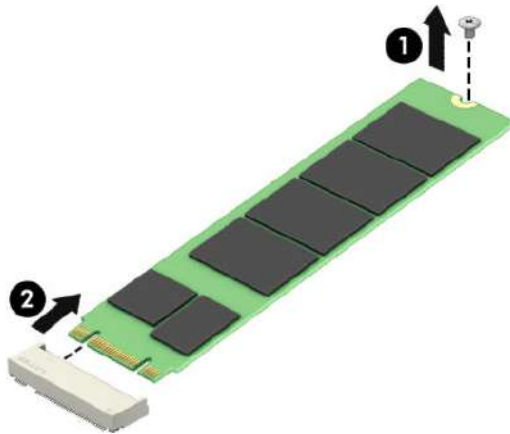

Reverse this procedure to install the Optane memory module.

WLAN module

Description	Spare part number
Intel Dual Band Wireless-AC 7265 802.11 AC 2×2 WiFi + Bluetooth 4.2 Combo Adapter (non-vPro)	901229-855
Intel Dual Band Wireless-AC 3168 802.11AC 1×1 WiFi + Bluetooth 4.2 Combo Adapter (non-vPro)	863934-855
Realtek RTL8822BE 802.11 ac 2x2 WiFi + Bluetooth 4.2 Combo Adapter (MU-MIMO supported)	924813-855
Realtek RTL8821CE 802.11 ac 1x1 WiFi + Bluetooth 4.2 Combo Adapter (MU-MIMO supported)	L17365-005

⚠ CAUTION: To prevent an unresponsive system, replace the wireless module only with a wireless module authorized for use in the computer by the governmental agency that regulates wireless devices in your country or region. If you replace the module and then receive a warning message, remove the module to restore device functionality, and then contact technical support.

Before removing the WLAN module, follow these steps:

1. Turn off the computer. If you are unsure whether the computer is off or in Hibernation, turn the computer on, and then shut it down through the operating system.
2. Disconnect the power from the computer by first unplugging the power cord from the AC outlet, and then unplugging the AC adapter from the computer.
3. Disconnect all external devices from the computer.
4. Remove the bottom cover (see [Bottom cover on page 33](#)).
5. Remove the battery (see [Battery on page 35](#)).

Remove the WLAN module:

1. Disconnect the antenna cables from the module **(1)**.

2. Remove the Phillips M2.0×3.0 screw (2), and then pull the module out of the socket (3).

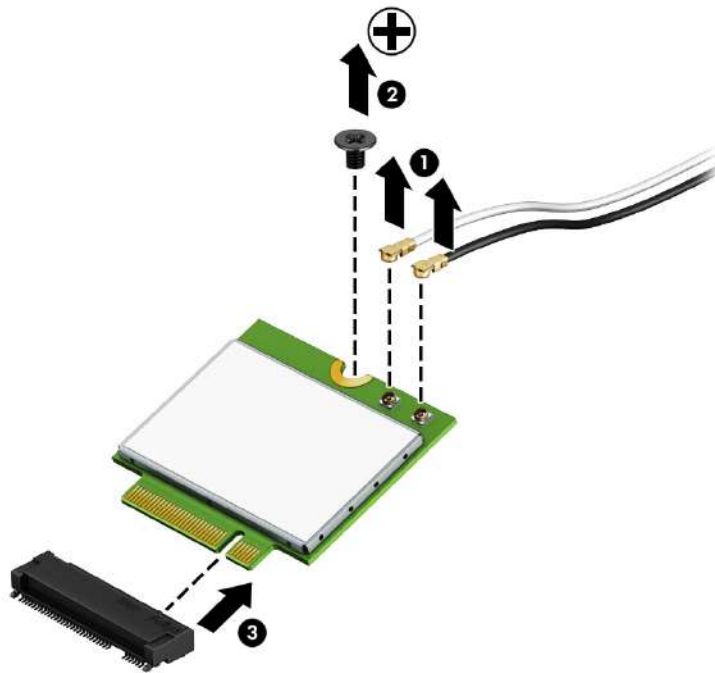

Reverse this procedure to install the WLAN module.

Hard drive

Description	Spare part number
1-TB, 5400-rpm, SATA, 8-GB hybrid hard drive	924036-855
1-TB, 5400-rpm, SATA hard drive	762990-005
500-GB, 5400-rpm, SATA hard drive	778186-005
Hard drive rubber sleeve for use in full-featured models	L18225-001
Hard drive rubber sleeve for use in full-featured plus models	L18226-001
Hard drive foil	L20549-001
Hard drive cable	L18218-001
Rubber hard drive insert (for use in models without a hard drive)	L20550-001

Before removing the hard drive, follow these steps:

1. Shut down the computer. If you are unsure whether the computer is off or in Hibernation, turn the computer on, and then shut it down through the operating system.
2. Disconnect all external devices connected to the computer.
3. Disconnect the power from the computer by first unplugging the power cord from the AC outlet, and then unplugging the AC adapter from the computer.
4. Remove the bottom cover (see [Bottom cover on page 33](#)).
5. Remove the battery (see [Battery on page 35](#)).

Remove the hard drive:

1. Release the ZIF connector **(1)**, and then disconnect the hard drive cable from the system board **(2)**.

2. Remove the hard drive from the computer (3).

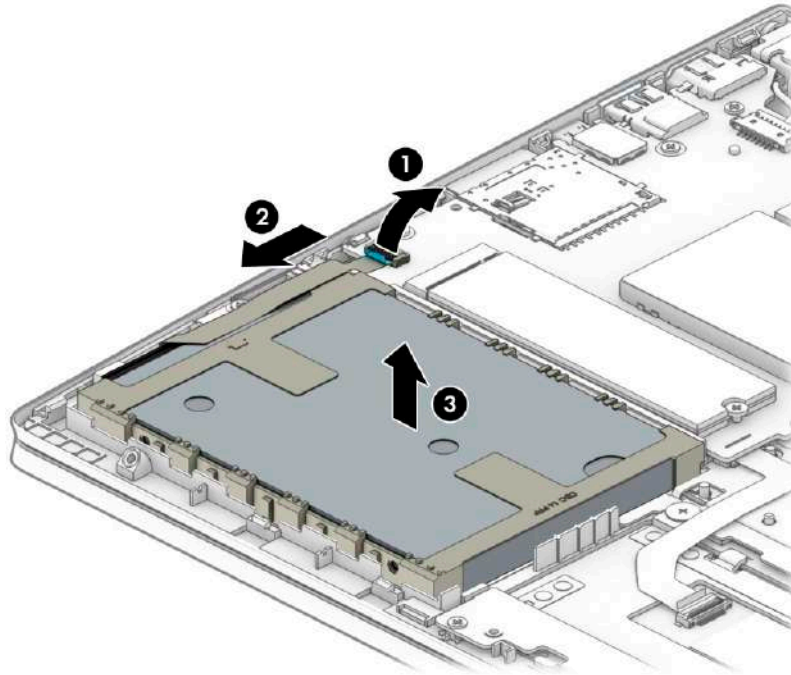

3. If it is necessary to remove the hard drive from the rubber sleeve, pull the sides of rubber sleeve away from the hard drive (1).
4. Disconnect the cable from the hard drive (2).

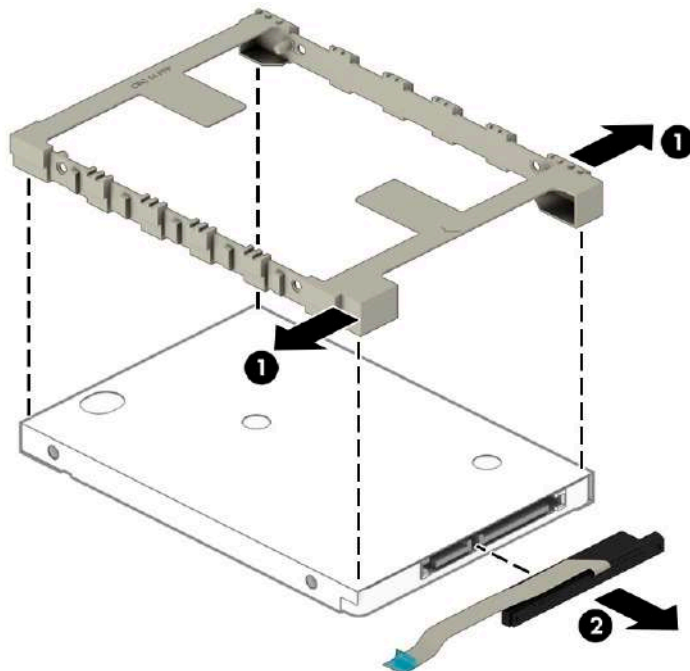

5. If it is necessary to remove the foil from the hard drive, pull up on the sides of the foil (1), lift the foil at the front of the drive (2), and then remove the foil from the drive (3).

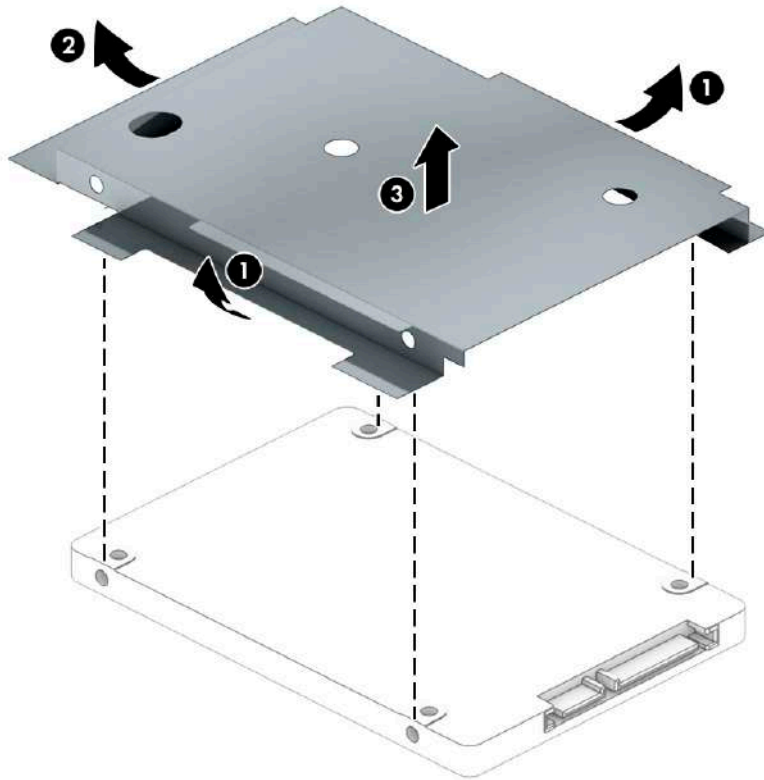

Reverse this procedure to reassemble and install the hard drive.

Memory module

 **NOTE:** The memory module spare part kit does not include the memory cover. The memory cover is available using spare part number L20548-001 (Miscellaneous Parts Kit).

 **NOTE:** Primary and expansion memory is installed in a side-by-side configuration in the bottom of the computer. If only one memory module is installed, it must be installed in the socket labeled 1.

Description	Spare part number
8-MB, DDR4-2400, 1.2-V	862398-855
4-MB, DDR4-2400, 1.2-V	862397-855
2-MB, DDR4-2133, 1.2-V	864271-855

Update BIOS before adding memory modules

Before adding new memory, make sure you update the computer to the latest BIOS.

 **CAUTION:** Failure to update the computer to the latest BIOS prior to installing new memory may result in various system problems.

To update BIOS:

1. Navigate to www.hp.com.
2. Click **Support**, and then click **Software & Drivers**.
3. **Personal Computing**
4. In the **Enter your HP product name, product number or serial number** box, type the computer model information, and then click **Find**.
5. (If necessary) Click the link for the computer model.
6. Click the **BIOS** link.
7. Click the **Download** button, and then follow the on-screen instructions.

Before removing the memory module, follow these steps:

1. Turn off the computer. If you are unsure whether the computer is off or in Hibernation, turn the computer on, and then shut it down through the operating system.
2. Disconnect the power from the computer by first unplugging the power cord from the AC outlet, and then unplugging the AC adapter from the computer.
3. Disconnect all external devices from the computer.
4. Remove the bottom cover (see [Bottom cover on page 33](#)).
5. Remove the battery (see [Battery on page 35](#)).

Remove the memory module:

1. Squeeze the sides of the memory cover **(1)**, and then lift the cover off the system board **(2)**.

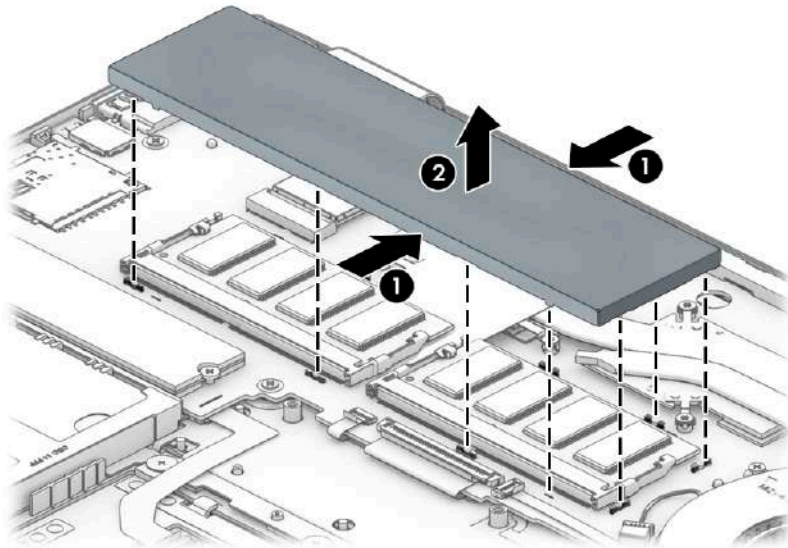

2. Spread the retaining tabs (1) on each side of the memory module slot to release the memory module. (The edge of the module opposite the slot rises away from the computer.)
3. Remove the memory module (2) by pulling the module away from the slot at an angle.

 **NOTE:** Memory modules are designed with a notch to prevent incorrect insertion.

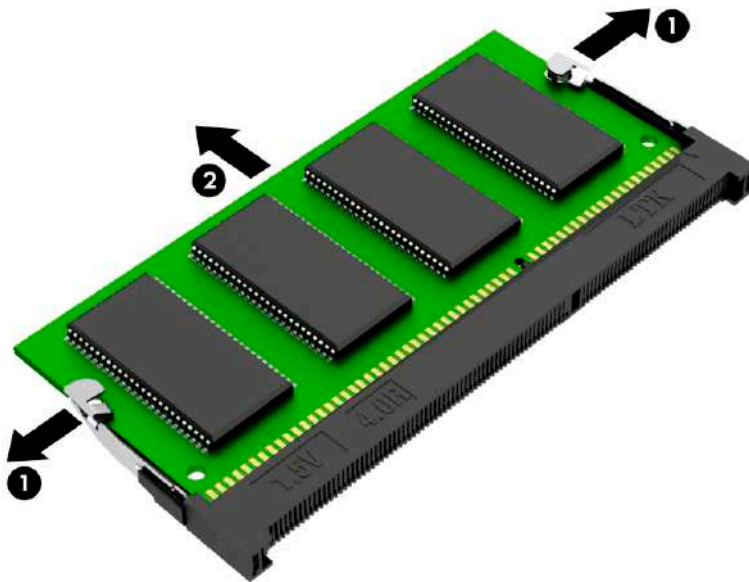

Reverse this procedure to install a memory module.

Ten small clips and four holes on the system board hold the memory cover in place. When replacing the memory cover, be sure to align the cover with these components.

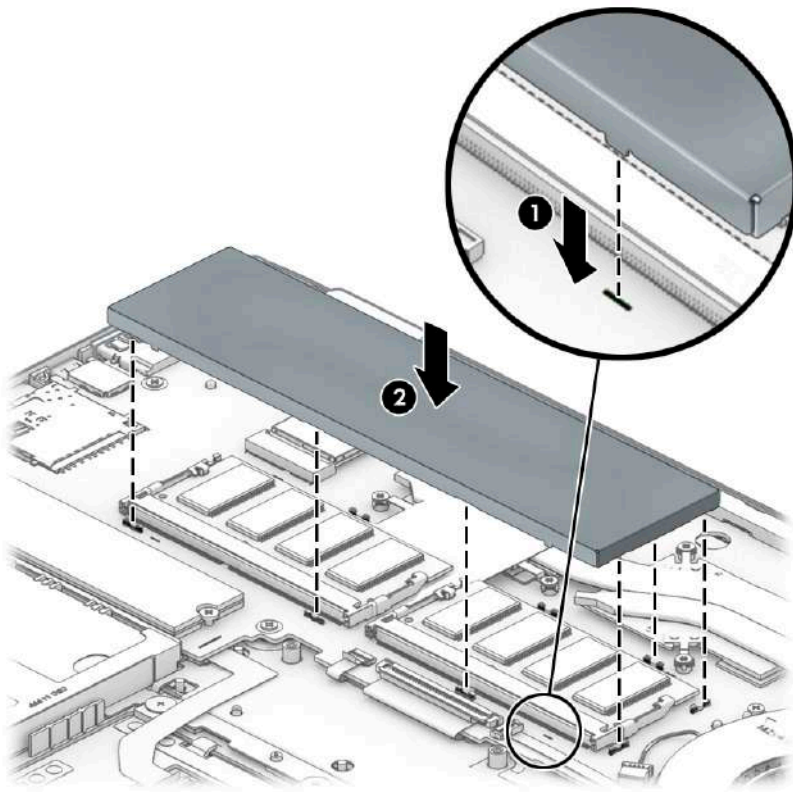

Power button board

Description	Spare part number
Power button board	L18206-001
Power button board cable	L18217-001

Before removing the power button board, follow these steps:

1. Shut down the computer. If you are unsure whether the computer is off or in Hibernation, turn the computer on, and then shut it down through the operating system.
2. Disconnect all external devices connected to the computer.
3. Disconnect the power from the computer by first unplugging the power cord from the AC outlet, and then unplugging the AC adapter from the computer.
4. Remove the bottom cover (see [Bottom cover on page 33](#)).
5. Remove the battery (see [Battery on page 35](#)).

Remove the power button board:

1. Disconnect the cable from the ZIF connector on the power board (1).
2. Remove the Phillips M2.0×3.0 screw (2) that secures the board to the computer.
3. Rotate the rear of the board up, and then lift it out of the computer (3).

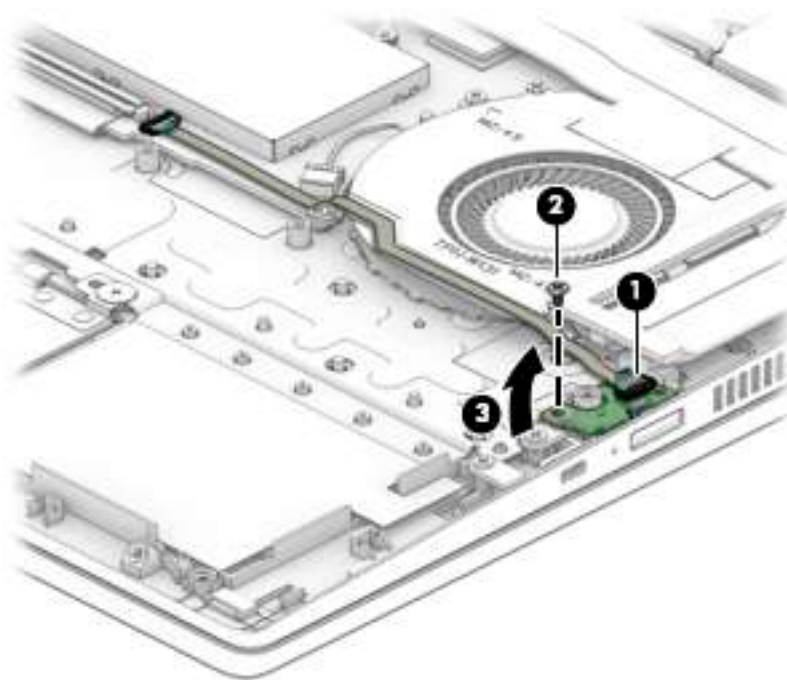

Reverse this procedure to install the power button board.

Fingerprint reader board

Description	Spare part number
Fingerprint reader board for use in full-featured models	L18208-001
Fingerprint reader module for use in full-featured plus models	L18210-001
Fingerprint bracket (included in the Miscellaneous Parts Kit)	L20548-001
Fingerprint reader board cable	L18219-001

Before removing the fingerprint reader board, follow these steps:

1. Shut down the computer. If you are unsure whether the computer is off or in Hibernation, turn the computer on, and then shut it down through the operating system.
2. Disconnect all external devices connected to the computer.
3. Disconnect the power from the computer by first unplugging the power cord from the AC outlet, and then unplugging the AC adapter from the computer.
4. Remove the bottom cover (see [Bottom cover on page 33](#)).
5. Remove the battery (see [Battery on page 35](#)).

Remove the fingerprint reader board:

1. Disconnect the cable from the fingerprint reader board ZIF connector (1).
2. Remove the Phillips M2.0×3.0 screw (2) that secures the board to the computer.
3. Lift the board out of the computer (3).

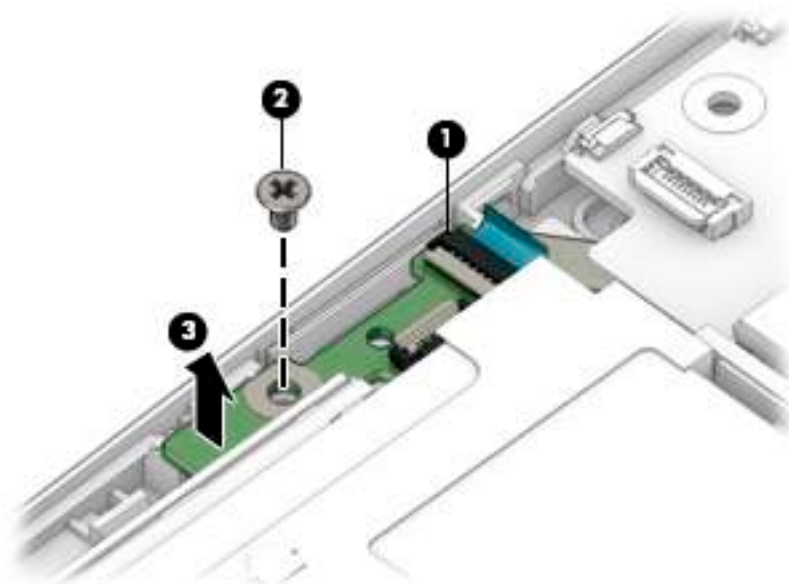

Reverse this procedure to install the fingerprint reader board.

TouchPad

Description	Spare part number
TouchPad for use in full-featured models	L18211-001
TouchPad for use in full-featured plus models	L18212-001
TouchPad bracket (available in the Miscellaneous Parts Kit)	L20548-001
TouchPad cable	L18215-001

Before removing the TouchPad, follow these steps:

1. Shut down the computer. If you are unsure whether the computer is off or in Hibernation, turn the computer on, and then shut it down through the operating system.
2. Disconnect all external devices connected to the computer.
3. Disconnect the power from the computer by first unplugging the power cord from the AC outlet, and then unplugging the AC adapter from the computer.
4. Remove the bottom cover (see [Bottom cover on page 33](#)).
5. Remove the battery (see [Battery on page 35](#)).

Remove the TouchPad:

1. Disconnect the cable from the TouchPad board ZIF connector **(1)**.
2. Remove the three Phillips M2.0×2.5 screws **(2)** that secure the TouchPad bracket to the computer.
3. Remove the bracket **(3)**.
4. Remove the three Phillips M2.0×2.5 broad head screws **(4)** that secure the TouchPad to the computer.

5. Remove the TouchPad (5).

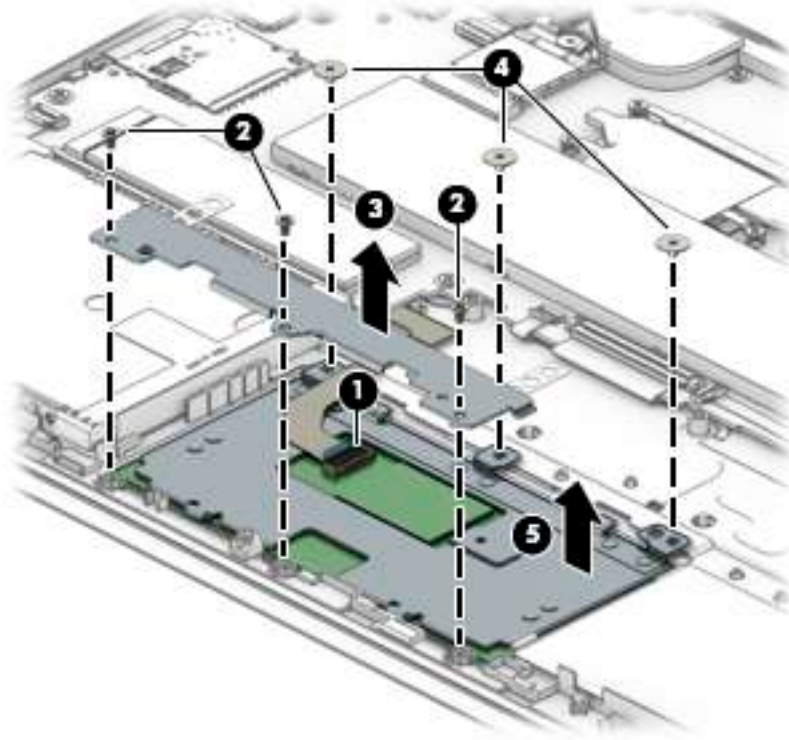

Reverse this procedure to install the TouchPad.

Speakers

Description	Spare part number
Speakers (includes cable)	L18227-001

Before removing the speakers, follow these steps:

1. Turn off the computer. If you are unsure whether the computer is off or in Hibernation, turn the computer on, and then shut it down through the operating system.
2. Disconnect the power from the computer by first unplugging the power cord from the AC outlet, and then unplugging the AC adapter from the computer.
3. Disconnect all external devices from the computer.
4. Remove the bottom cover (see [Bottom cover on page 33](#)).
5. Remove the battery (see [Battery on page 35](#)).

Remove the speakers:

1. Disconnect the cables the retention clips (1).
2. Disconnect the speaker cables (2) that secure the speakers to the computer.
3. Remove the speakers (3).

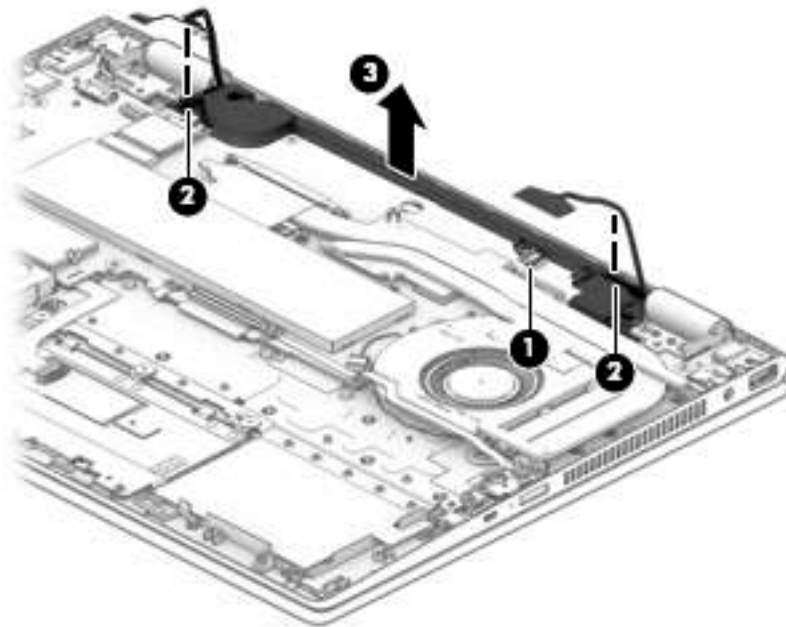

 **NOTE:** On select models, you may have to remove the two Phillips M2.0×6.0 screws.

Reverse this procedure to install the speakers.

Camera, world-facing

Description	Spare part number
Camera, world-facing	L18181-001

Before removing the camera, follow these steps:

1. Turn off the computer. If you are unsure whether the computer is off or in Hibernation, turn the computer on, and then shut it down through the operating system.
2. Disconnect the power from the computer by first unplugging the power cord from the AC outlet, and then unplugging the AC adapter from the computer.
3. Disconnect all external devices from the computer.
4. Remove the bottom cover (see [Bottom cover on page 33](#)).
5. Remove the battery (see [Battery on page 35](#)).
6. Remove the speakers (see [Speakers on page 50](#)).

Remove the camera:

1. Remove the gasket from the top of the bracket (1).
2. Remove the Phillips M2.0×3.0 screw (2) that secures the bracket to the computer.
3. Remove the bracket from on top of the camera module (3).
4. Disconnect the cable from the ZIF connector on the system board (4).
5. Remove the camera module from the computer (5).

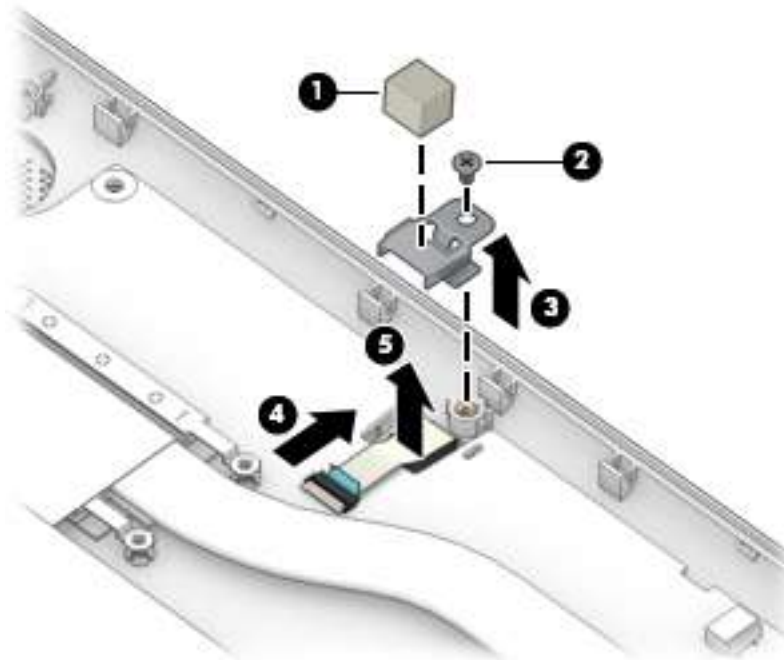

Reverse this procedure to install the camera.

Display assembly



NOTE: The display assembly is spared only as an entire hinge-up. Display subcomponents are not spared.

Description	Spare part number
Display assembly, FHD, BrightView with HD camera, mineral silver	L18192-001
Display assembly, FHD panel, BrightView, IR camera, natural silver	L20551-001
Display assembly, FHD panel, BrightView, HD camera, natural silver	L20552-001
Display assembly, HD panel, anti glare, HD camera, natural silver	L20553-001
Display assembly, FHD panel, BrightView, IR camera, pale gold	L20554-001
Display assembly, FHD panel, BrightView, HD camera, pale gold	L20555-001
Display assembly, HD panel, anti glare, HD camera, pale gold	L20556-001
Display assembly, FHD panel, BrightView, IR camera, sapphire blue	L20557-001
Display assembly, FHD panel, BrightView, HD camera, sapphire blue	L20558-001
Display assembly, HD panel, anti glare, HD camera, sapphire blue	L20559-001

Before removing the display assembly, follow these steps:

1. Shut down the computer. If you are unsure whether the computer is off or in Hibernation, turn the computer on, and then shut it down through the operating system.
2. Disconnect all external devices connected to the computer.
3. Disconnect the power from the computer by first unplugging the power cord from the AC outlet, and then unplugging the AC adapter from the computer.
4. Remove the bottom cover (see [Bottom cover on page 33](#)).
5. Remove the battery (see [Battery on page 35](#)).

Remove the display assembly:

1. Disconnect the antenna cables from WLAN module **(1)**.
2. Disconnect the camera (CCD) cable from the system board ZIF connector **(2)**.
3. Disconnect the display cable from the system board ZIF connector **(3)**.
4. Remove the camera cable and antenna cable from the clips in the left speaker **(4)**.

5. Remove the display cable from the clips in the right speaker (5).

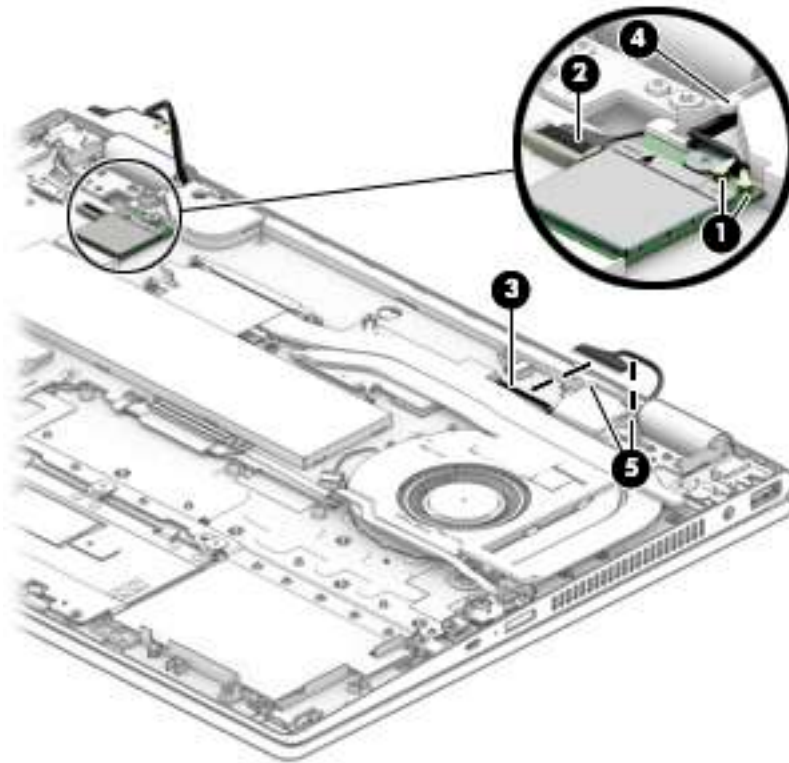

6. Open display to approximately 270 degrees (1).
7. Remove the four Phillips PM2.5×4.0 screws (2) that secure the display assembly to the computer.

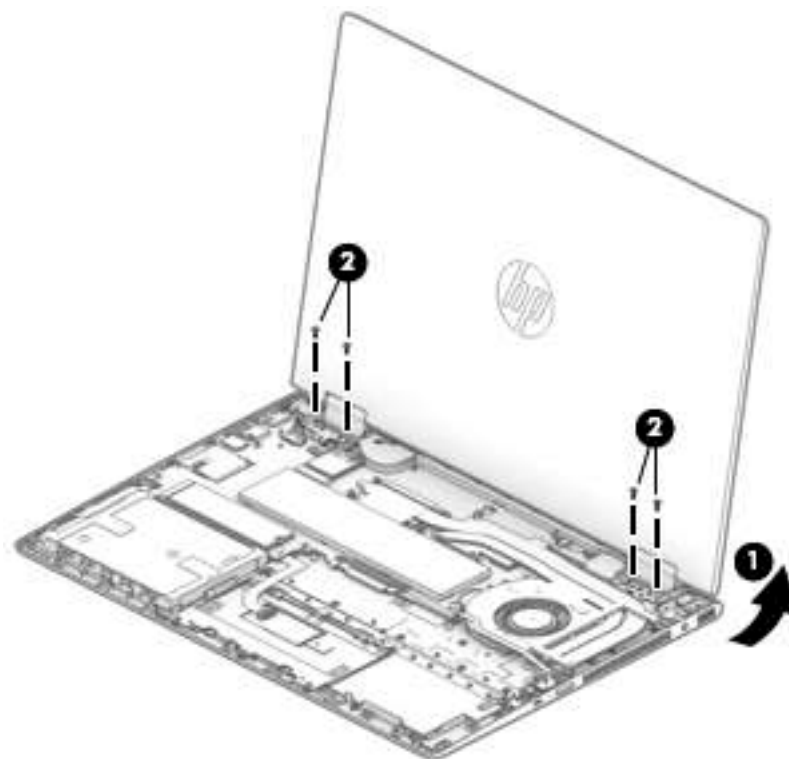

8. With display open about 270 degrees (1), pull the display away to separate it from of computer (2).

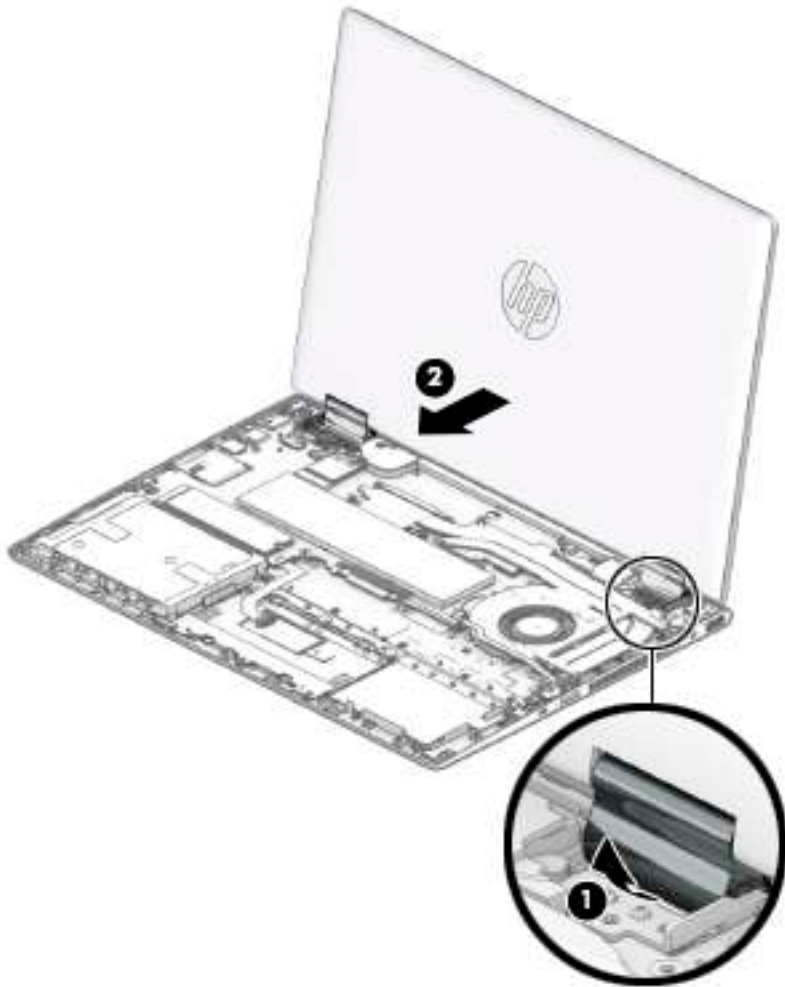

Reverse this procedure to install the display assembly.

Power connector cable

Description	Spare part number
Power connector cable	L18220-001

Before removing the power connector cable, follow these steps:

1. Shut down the computer. If you are unsure whether the computer is off or in Hibernation, turn the computer on, and then shut it down through the operating system.
2. Disconnect all external devices connected to the computer.
3. Disconnect the power from the computer by first unplugging the power cord from the AC outlet, and then unplugging the AC adapter from the computer.
4. Remove the bottom cover (see [Bottom cover on page 33](#)).
5. Remove the battery (see [Battery on page 35](#)).
6. Remove the display (see [Display assembly on page 52](#)).

Remove the power connector cable:

1. Disconnect the power connector cable from the system board (1).
2. Remove the power connector cable from the computer (2).

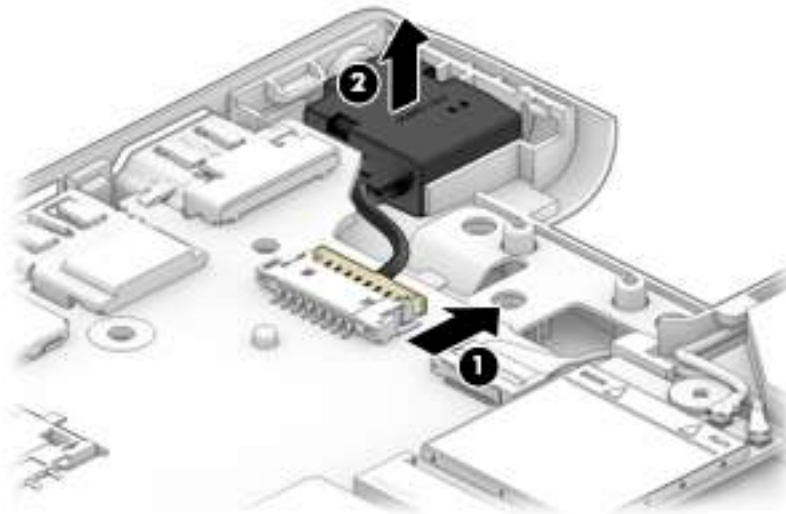

Reverse this procedure to install the power connector cable.

System board



NOTE: All system board spare part kits include a processor and replacement thermal material.

Description	Spare part number
System board for use in models with discrete graphics:	
<ul style="list-style-type: none">Intel Core i7-8565U processor and 4 GB of discrete graphics memory	L36453-xx1
<ul style="list-style-type: none">Equipped with an Intel Core i7-8550U processor and 4 GB of discrete graphics memory for use in models with an HD camera	L18159-xx1
<ul style="list-style-type: none">Equipped with an Intel Core i7-8550U processor and 4 GB of discrete graphics memory for use in models with an IR camera	L18171-xx1
<ul style="list-style-type: none">Equipped with an Intel Core i5-8265U processor and 2 GB of discrete graphics memory	L36452-xx1
<ul style="list-style-type: none">Equipped with an Intel Core i5-8250U processor and 2 GB of discrete graphics memory	L18157-xx1
<ul style="list-style-type: none">Equipped with an Intel Core i3-8145U processor and 2 GB of discrete graphics memory	L36451-xx1
<ul style="list-style-type: none">Equipped with an Intel Core i3-8130U processor and 2 GB of discrete graphics memory	L18173-xx1
System board for use in models with UMA graphics:	
<ul style="list-style-type: none">Equipped with an Intel Core i5-8250U processor for use in models with an HD camera	L18163-xx1
<ul style="list-style-type: none">Equipped with an Intel Core i5-8250U processor for use in models with an IR camera	L18165-xx1
<ul style="list-style-type: none">Equipped with an Intel Core i5-8250U processor, HD camera, and world-facing camera	L18167-xx1
<ul style="list-style-type: none">Equipped with an Intel Core i5-8265U processor	L36455-xx1
<ul style="list-style-type: none">Equipped with an Intel Core i3-8145U processor	L36454-xx1
<ul style="list-style-type: none">Equipped with an Intel Core i3-8130U processor	L18175-xx1
<ul style="list-style-type: none">Equipped with an Intel Core i3-8130U processor, HD camera, and world-facing camera	L18177-xx1
<ul style="list-style-type: none">Equipped with an Intel Core i3-7100U processor	L43724-xx1
<ul style="list-style-type: none">Equipped with an Intel Pentium 4415U processor	L18169-xx1

Before removing the system board, follow these steps:

1. Shut down the computer. If you are unsure whether the computer is off or in Hibernation, turn the computer on, and then shut it down through the operating system.
2. Disconnect all external devices connected to the computer.
3. Disconnect the power from the computer by first unplugging the power cord from the AC outlet, and then unplugging the AC adapter from the computer.
4. Remove the bottom cover (see [Bottom cover on page 33](#)).
5. Remove the battery (see [Battery on page 35](#)).

When replacing the system board, be sure to remove the following components from the defective system board and install them on the replacement system board:

- WLAN module (see [WLAN module on page 38](#))
- Solid-state drive (see [Solid-state drive on page 36](#)) or Optane memory module (see [Optane memory module on page 37](#))
- Memory modules (see [Memory module on page 43](#))

Remove the system board:

1. Disconnect the following cables:
 - (1): Power button board cable
 - (2): Keyboard cable
 - (2): Backlight cable
 - (4): TouchPad cable from the Touchpad
 - (5): Hard drive cable
 - (6): Fingerprint reader cable
 - (7): Power connector cable
 - (8): Camera cable
 - (9): Speaker cable
 - (10): Display cable

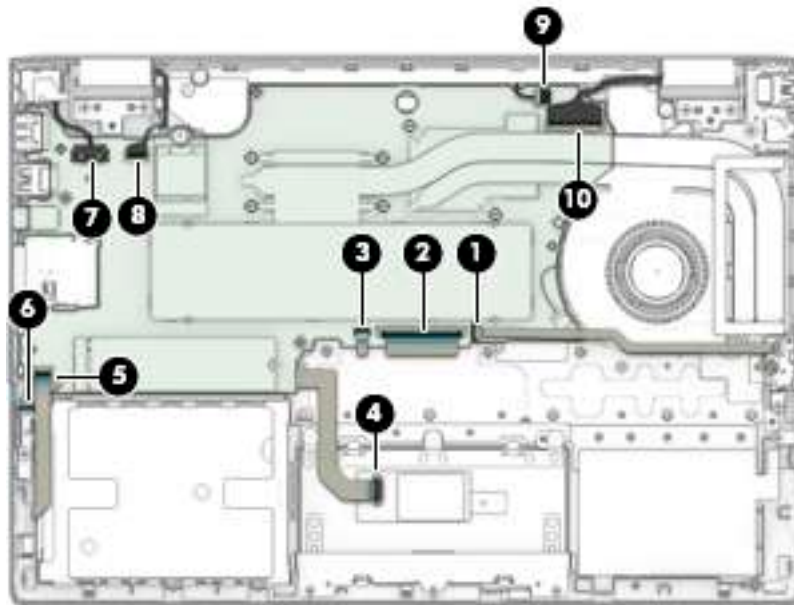

2. Remove the two Phillips M2.0×4.5 screws and the Phillips M2.0×3.0 screw (1) that secure the fan to the computer.
3. Remove the two Phillips M2.0×3.0 screws and Phillips M2.0×3.5 screw (2) that secure the system board to the computer.
4. Remove the Phillips M2.0×3.0 screws and the Phillips M2.0×3.5 screw (3) that secure the system board to the computer.

5. Remove the Phillips M2.0×3.0 screw (4) that secures the USB/audio board to the computer.

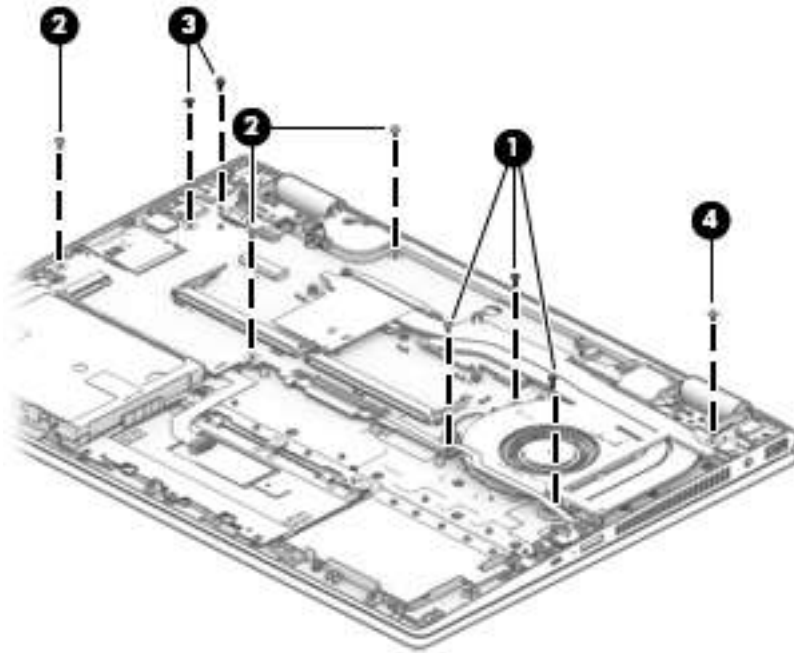

6. Lift the system board until it rests at an angle (1).
7. Remove the system board by pulling it away from and out of the computer (2).

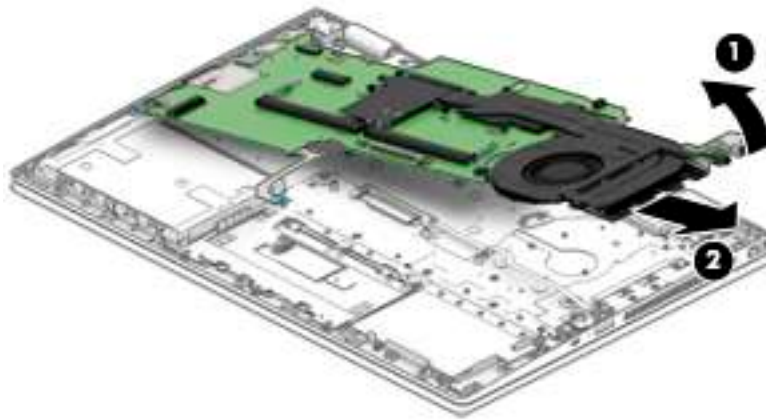

8. After removing the system board, three cables remaining connected. If you are replacing the system board, be sure to replace the following cables:

(1): Fingerprint reader cable

(2): TouchPad cable

(3): USB/audio board cable

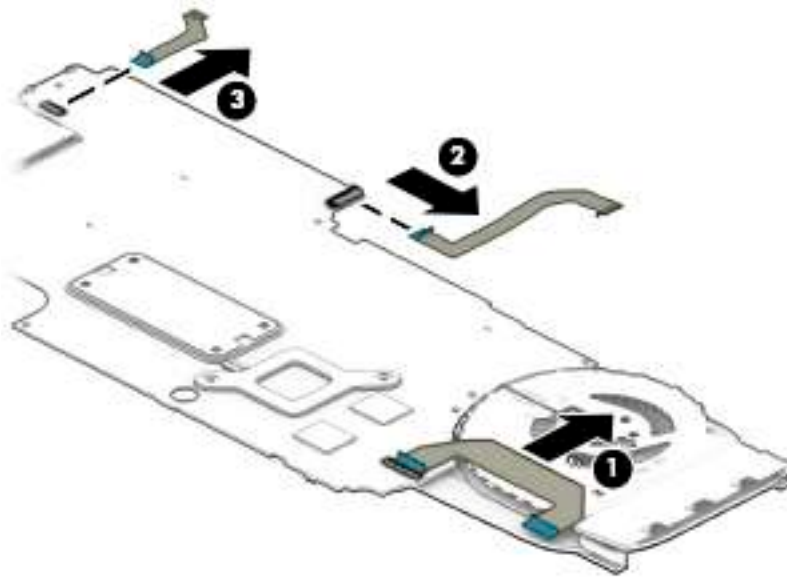

Reverse this procedure to install the system board.

USB/audio board

Description	Spare part number
USB/audio board for use in full-featured models	L18204-001, L36458-001
USB/audio board for use in full-featured plus models	L18205-001, L36459-001
USB/audio board cable	L20816-001

Before removing the USB/audio board, follow these steps:

1. Shut down the computer. If you are unsure whether the computer is off or in Hibernation, turn the computer on, and then shut it down through the operating system.
2. Disconnect all external devices connected to the computer.
3. Disconnect the power from the computer by first unplugging the power cord from the AC outlet, and then unplugging the AC adapter from the computer.
4. Remove the bottom cover (see [Bottom cover on page 33](#)).
5. Remove the battery (see [Battery on page 35](#)).
6. Remove the system board (see [System board on page 56](#)).

Remove the USB/audio board:

1. Position the removed system board upright.
2. Disconnect the cable from the ZIF connector on the USB/audio board (1).
3. Remove the board from the system board (2).

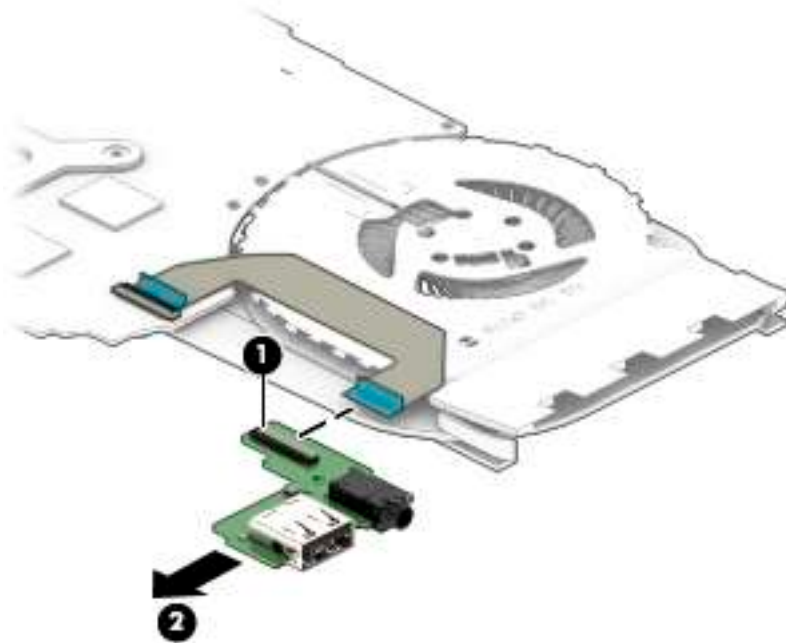

Reverse this procedure to install the USB/audio board.

Fan/heat sink assembly

Description	Spare part number
Fan/heat sink for use in models equipped with a discrete graphics memory subsystem	L18221-001, L36456-001
Thermal pad for use in models with discrete graphics	L21302-001, L36457-001
Fan/heat sink for use in models equipped with a UMA graphics subsystem	L18222-001

Before removing the fan/heat sink assembly, follow these steps:

1. Turn off the computer. If you are unsure whether the computer is off or in Hibernation, turn the computer on, and then shut it down through the operating system.
2. Disconnect the power from the computer by first unplugging the power cord from the AC outlet, and then unplugging the AC adapter from the computer.
3. Disconnect all external devices from the computer.
4. Remove the bottom cover (see [Bottom cover on page 33](#)).
5. Remove the battery (see [Battery on page 35](#)).

Remove the fan/heat sink assembly:

1. **Discrete models:**
Disconnect the fan cable from the system board **(1)**.
2. Disconnect the cable from the ZIF connector on the power board **(2)**.
3. In the order shown, remove the eight Phillips M2.0×4.0 screws **(3)** that secure the fan/heat sink assembly to the system board.

4. Remove the fan/heat sink assembly (4).

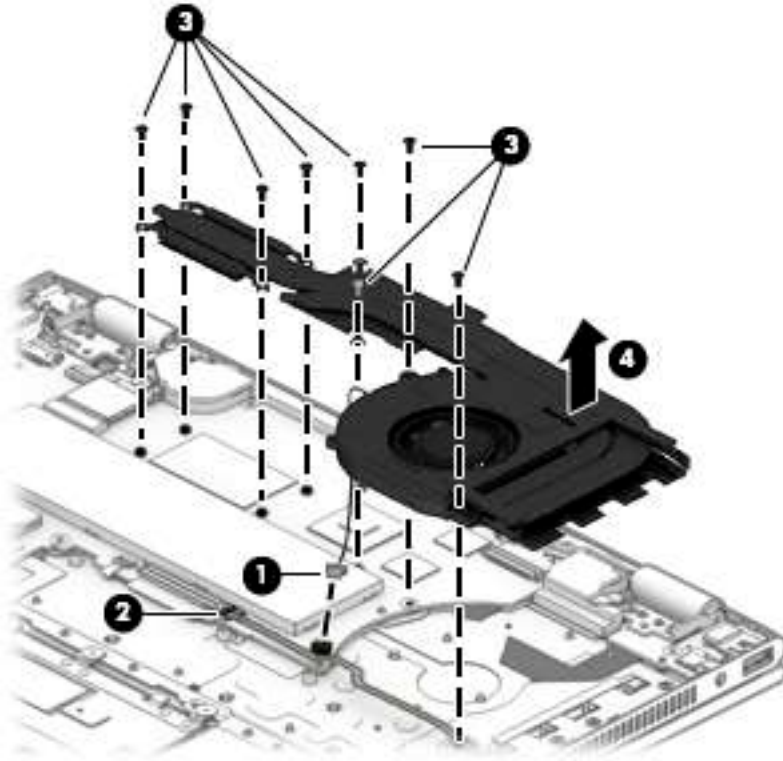

5. Thoroughly clean the thermal material from the surfaces of the fan/heat sink assembly and the system board components each time the fan/heat sink assembly is removed. Replacement thermal material is included with the fan/heat sink assembly and system board spare part kits.

Thermal paste is used on the processor (1) and the heat sink section (2) that services it. Thermal paste is also used on the VGA component (3) and the heat sink section (4) that services it.

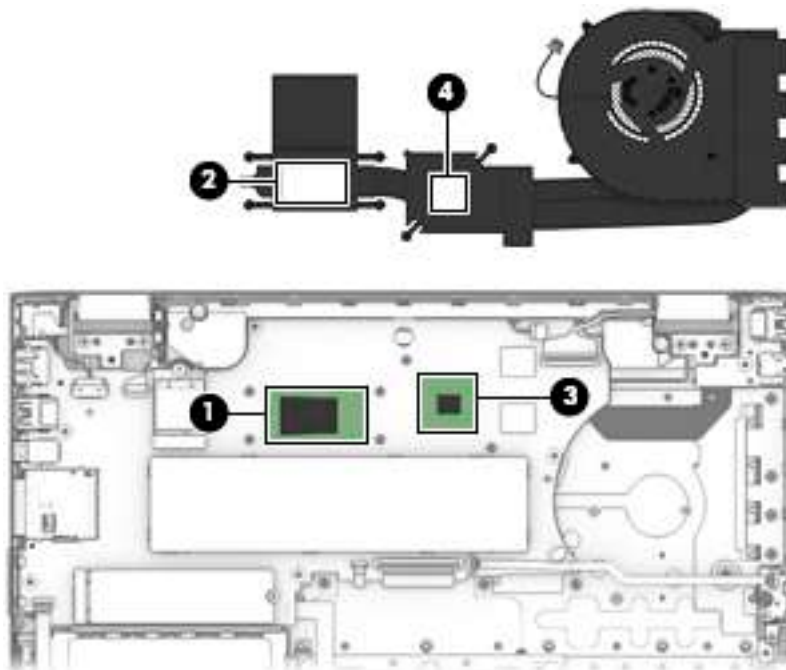

6. **UMA models:**

Disconnect the fan cable from the system board (1).

7. Disconnect the cable from the ZIF connector on the power board (2).

8. In the order shown, remove the six Phillips M2.0×4.0 screws (3) that secure the fan/heat sink assembly to the system board.

9. Remove the fan/heat sink assembly (4).

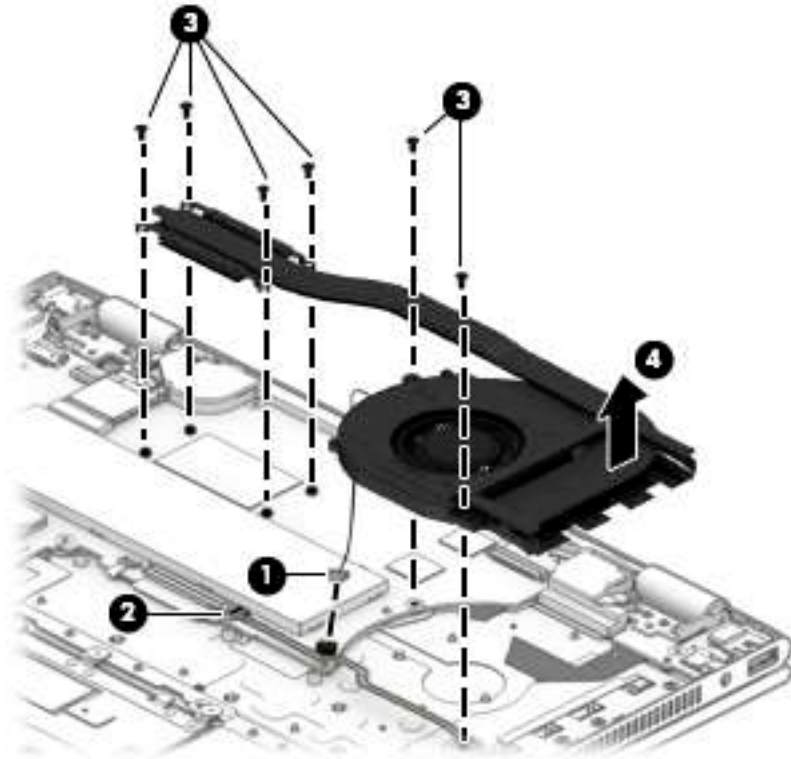

10. Thoroughly clean the thermal material from the surfaces of the fan/heat sink assembly and the system board components each time the fan/heat sink assembly is removed. Replacement thermal material is included with the fan/heat sink assembly and system board spare part kits.

Thermal paste is used on the processor (1) and the heat sink section (2) that services it.

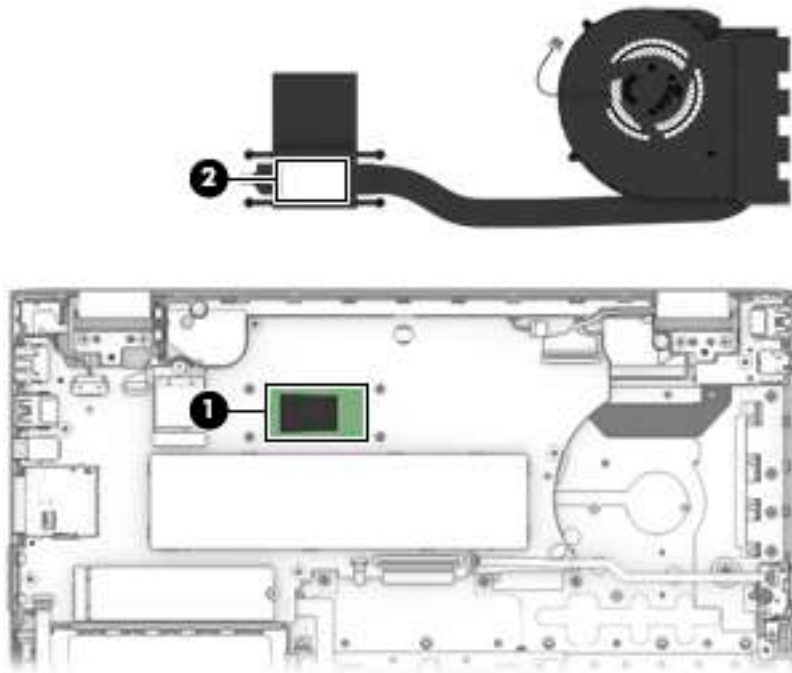

Reverse this procedure to install the fan/heat sink assembly.

Top cover with keyboard

The top cover with keyboard remains after removing all other spared parts from the computer.

In this section, the first table provides the main spare part number for the keyboards. The second table provides the country codes.

Description	Spare part number
Keyboard, backlit, full-featured models, natural silver	L18946-001
Keyboard, no backlight, full-featured models, natural silver	L18947-001
Keyboard, backlit, full-featured models, pale gold	L18948-001
Keyboard, no backlight, full-featured models, pale gold	L18949-001
Keyboard, backlit, full-featured models, sapphire blue	L18950-001
Keyboard, no backlight, full-featured models, sapphire blue	L18951-001
Keyboard, no backlight, full-featured models+	L18952-001
Keyboard, backlit, full-featured models+	L18953-001
Keyboard, no backlight, full-featured models+, MIPI	L18954-001
Keyboard, backlit, full-featured models+, MIPI	L18955-001

For use in country or region	Spare part number	For use in country or region	Spare part number	For use in country or region	Spare part number
Belgium	-A41	Hungary	-211	Saudi Arabia	-171
Bulgaria	-261	Israel	-BB1	Slovenia	-BA1
Canada	-DB1	Italy	-061	Spain	-071
Czech Republic and Slovakia	-FL1	Latin America	-161	Switzerland	-BG1
Denmark, Finland, and Norway	-DH1	The Netherlands	-B31	Turkey	-141
France	-051	Portugal	-131	United Kingdom	-031
Germany	-041	Romania	-271	United States	-001
Greece	-151				

6 Using Setup Utility (BIOS)

Setup Utility, or Basic Input/Output System (BIOS), controls communication between all the input and output devices on the system (such as disk drives, display, keyboard, mouse, and printer). Setup Utility (BIOS) includes settings for the types of devices installed, the startup sequence of the computer, and the amount of system and extended memory.

 **NOTE:** To start Setup Utility on convertible computers, your computer must be in notebook mode and you must use the keyboard attached to your notebook.

Starting Setup Utility (BIOS)

 **CAUTION:** Use extreme care when making changes in Setup Utility (BIOS). Errors can prevent the computer from operating properly.

- ▲ Turn on or restart the computer, quickly press `esc`, and then press `f10`.

Updating Setup Utility (BIOS)

Updated versions of Setup Utility (BIOS) may be available on the HP website.

Most BIOS updates on the HP website are packaged in compressed files called *SoftPaqs*.

Some download packages contain a file named `Readme.txt`, which contains information regarding installing and troubleshooting the file.

Determining the BIOS version

To decide whether you need to update Setup Utility (BIOS), first determine the BIOS version on your computer.

To reveal the BIOS version information (also known as *ROM date* and *System BIOS*), use one of these options.

- HP Support Assistant
 1. Type `support` in the taskbar search box, and then select the **HP Support Assistant** app.
– or –
Click the question mark icon in the taskbar.
 2. Select **My PC**, and then select **Specifications**.
- Setup Utility (BIOS)
 1. Start Setup Utility (BIOS) (see [Starting Setup Utility \(BIOS\) on page 66](#)).
 2. Select **Main**, select **System Information**, and then make note of the BIOS version.
 3. Select **Exit**, select **No**, and then follow the on-screen instructions.

To check for later BIOS versions, see [Downloading a BIOS update on page 67](#).

Downloading a BIOS update

 **CAUTION:** To reduce the risk of damage to the computer or an unsuccessful installation, download and install a BIOS update only when the computer is connected to reliable external power using the AC adapter. Do not download or install a BIOS update while the computer is running on battery power, docked in an optional docking device, or connected to an optional power source. During the download and installation, follow these instructions:

- Do not disconnect power from the computer by unplugging the power cord from the AC outlet.
- Do not shut down the computer or initiate Sleep.
- Do not insert, remove, connect, or disconnect any device, cable, or cord.

 **NOTE:** If your computer is connected to a network, consult the network administrator before installing any software updates, especially system BIOS updates.

1. Type `support` in the taskbar search box, and then select the **HP Support Assistant** app.
– or –
Click the question mark icon in the taskbar.
2. Click **Updates**, and then click **Check for updates and messages**.
3. Follow the on-screen instructions.
4. At the download area, follow these steps:
 - a. Identify the most recent BIOS update and compare it to the BIOS version currently installed on your computer. If the update is more recent than your BIOS version, make a note of the date, name, or other identifier. You may need this information to locate the update later, after it has been downloaded to your hard drive.
 - b. Follow the on-screen instructions to download your selection to the hard drive.

Make a note of the path to the location on your hard drive where the BIOS update is downloaded. You will need to access this path when you are ready to install the update.

BIOS installation procedures vary. Follow any instructions that appear on the screen after the download is complete. If no instructions appear, follow these steps:

1. Type `file` in the taskbar search box, and then select **File Explorer**.
2. Click your hard drive designation. The hard drive designation is typically Local Disk (C:).
3. Using the hard drive path you recorded earlier, open the folder that contains the update.
4. Double-click the file that has an .exe extension (for example, *filename.exe*).

The BIOS installation begins.
5. Complete the installation by following the on-screen instructions.

 **NOTE:** After a message on the screen reports a successful installation, you can delete the downloaded file from your hard drive.

7 Using HP PC Hardware Diagnostics

Using HP PC Hardware Diagnostics Windows

HP PC Hardware Diagnostics Windows is a Windows-based utility that allows you to run diagnostic tests to determine whether the computer hardware is functioning properly. The tool runs within the Windows operating system in order to diagnose hardware failures.

If HP PC Hardware Diagnostics Windows is not installed on your computer, first you must download and install it. To download HP PC Hardware Diagnostics Windows, see [Downloading HP PC Hardware Diagnostics Windows on page 68](#).

After HP PC Hardware Diagnostics Windows is installed, follow these steps to access it from HP Help and Support or HP Support Assistant.

1. To access HP PC Hardware Diagnostics Windows from HP Help and Support:
 - a. Select the **Start** button, and then select **HP Help and Support**.
 - b. Right-click **HP PC Hardware Diagnostics Windows**, select **More**, and then select **Run as administrator**.

– or –

To access HP PC Hardware Diagnostics Windows from HP Support Assistant:

- a. Type `support` in the taskbar search box, and then select the **HP Support Assistant** app.
- or –
- a. Select the question mark icon in the taskbar.
 - b. Select **Troubleshooting and fixes**.
 - c. Select **Diagnostics**, and then select **HP PC Hardware Diagnostics Windows**.
2. When the tool opens, select the type of diagnostic test you want to run, and then follow the on-screen instructions.



NOTE: If you need to stop a diagnostic test at any time, select **Cancel**.

3. When HP PC Hardware Diagnostics Windows detects a failure that requires hardware replacement, a 24-digit Failure ID code is generated. For assistance in correcting the problem, contact support, and then provide the Failure ID code.

Downloading HP PC Hardware Diagnostics Windows

- The HP PC Hardware Diagnostics Windows download instructions are provided in English only.
- You must use a Windows computer to download this tool because only .exe files are provided.

Downloading the latest HP PC Hardware Diagnostics Windows version

To download HP PC Hardware Diagnostics Windows, follow these steps:

1. Go to <http://www.hp.com/go/techcenter/pcdiags>. The HP PC Diagnostics home page is displayed.
2. In the **HP PC Hardware Diagnostics** section, select **Download**, and then select the installation location:
To run the tool on your computer, download it to the computer desktop.
– or –
To run the tool from a USB flash drive, download it to a USB flash drive.
3. Select **Run**.

Downloading HP Hardware Diagnostics Windows by product name or number (select products only)

 **NOTE:** For some products, it may be necessary to download the software to a USB flash drive by using the product name or number.

To download HP PC Hardware Diagnostics Windows by product name or number (select products only), follow these steps:

1. Go to <http://www.hp.com/support>.
2. Select **Get software and drivers**, and then enter the product name or number.
3. In the **HP PC Hardware Diagnostics** section, select **Download**, and then select the installation location:
To run the tool on your computer, download it to the computer desktop.
– or –
To run the tool from a USB flash drive, download it to a USB flash drive.
4. Select **Run**.

Installing HP PC Hardware Diagnostics Windows

To install HP PC Hardware Diagnostics Windows, follow these steps:

- ▲ Navigate to the folder on your computer or the flash drive where the .exe file was downloaded, double-click the .exe file, and then follow the on-screen instructions.

Using HP PC Hardware Diagnostics UEFI

HP PC Hardware Diagnostics UEFI (Unified Extensible Firmware Interface) allows you to run diagnostic tests to determine whether the computer hardware is functioning properly. The tool runs outside the operating system so that it can isolate hardware failures from issues that are caused by the operating system or other software components.

If your PC will not boot into Windows, you can use HP PC Hardware Diagnostics UEFI to diagnose hardware issues.

When HP PC Hardware Diagnostics UEFI detects a failure that requires hardware replacement, a 24-digit Failure ID code is generated. For assistance in correcting the problem, contact support, and provide the Failure ID code.

 **NOTE:** To start diagnostics on a convertible computer, your computer must be in notebook mode, and you must use the attached keyboard.

 **NOTE:** If you need to stop a diagnostic test, press **esc**.

Starting HP PC Hardware Diagnostics UEFI

To start HP PC Hardware Diagnostics UEFI, follow these steps:

1. Turn on or restart the computer, and quickly press [esc](#).
2. Press [f2](#).

The BIOS searches three places for the diagnostic tools, in the following order:

- a. Connected USB flash drive



NOTE: To download the HP PC Hardware Diagnostics UEFI tool to a USB flash drive, see [Downloading the latest HP PC Hardware Diagnostics UEFI version on page 70](#).

- b. Hard drive
- c. BIOS

3. When the diagnostic tool opens, select the type of diagnostic test you want to run, and then follow the on-screen instructions.

Downloading HP PC Hardware Diagnostics UEFI to a USB flash drive

Downloading HP PC Hardware Diagnostics UEFI to a USB flash drive can be useful in the following situations:

- HP PC Hardware Diagnostics UEFI is not included in the preinstall image.
- HP PC Hardware Diagnostics UEFI is not included in the HP Tool partition.
- The hard drive is damaged.



NOTE: The HP PC Hardware Diagnostics UEFI download instructions are provided in English only, and you must use a Windows computer to download and create the HP UEFI support environment because only .exe files are provided.

Downloading the latest HP PC Hardware Diagnostics UEFI version

To download the latest HP PC Hardware Diagnostics UEFI version to a USB flash drive:

1. Go to <http://www.hp.com/go/techcenter/pcdiags>. The HP PC Diagnostics home page is displayed.
2. In the **HP PC Hardware Diagnostics UEFI** section, select **Download UEFI Diagnostics**, and then select **Run**.

Downloading HP PC Hardware Diagnostics UEFI by product name or number (select products only)



NOTE: For some products, it may be necessary to download the software to a USB flash drive by using the product name or number.

To download HP PC Hardware Diagnostics UEFI by product name or number (select products only) to a USB flash drive:

1. Go to <http://www.hp.com/support>.
2. Enter the product name or number, select your computer, and then select your operating system.
3. In the **Diagnostics** section, follow the on-screen instructions to select and download the specific UEFI Diagnostics version for your computer.

Using Remote HP PC Hardware Diagnostics UEFI settings (select products only)

Remote HP PC Hardware Diagnostics UEFI is a firmware (BIOS) feature that downloads HP PC Hardware Diagnostics UEFI to your computer. It can then execute the diagnostics on your computer, and it may upload results to a preconfigured server. For more information on Remote HP PC Hardware Diagnostics UEFI, go to <http://www.hp.com/go/techcenter/pcdiags>, and then select **Find out more**.

Downloading Remote HP PC Hardware Diagnostics UEFI

 **NOTE:** HP Remote PC Hardware Diagnostics UEFI is also available as a Softpaq that can be downloaded to a server.

Downloading the latest Remote HP PC Hardware Diagnostics UEFI version

To download the latest Remote HP PC Hardware Diagnostics UEFI version, follow these steps:

1. Go to <http://www.hp.com/go/techcenter/pcdiags>. The HP PC Diagnostics home page is displayed.
2. In the **HP PC Hardware Diagnostics UEFI** section, select **Download Remote Diagnostics**, and then select **Run**.

Downloading Remote HP PC Hardware Diagnostics UEFI by product name or number

 **NOTE:** For some products, it may be necessary to download the software by using the product name or number.

To download HP Remote PC Hardware Diagnostics UEFI by product name or number, follow these steps:

1. Go to <http://www.hp.com/support>.
2. Select **Get software and drivers**, enter the product name or number, select your computer, and then select your operating system.
3. In the **Diagnostics** section, follow the on-screen instructions to select and download the **Remote UEFI** version for the product.

Customizing Remote HP PC Hardware Diagnostics UEFI settings

Using the Remote HP PC Hardware Diagnostics setting in Computer Setup (BIOS), you can perform the following customizations:

- Set a schedule for running diagnostics unattended. You can also start diagnostics immediately in interactive mode by selecting **Execute Remote HP PC Hardware Diagnostics**.
- Set the location for downloading the diagnostic tools. This feature provides access to the tools from the HP website or from a server that has been preconfigured for use. Your computer does not require the traditional local storage (such as a disk drive or USB flash drive) to run remote diagnostics.
- Set a location for storing the test results. You can also set the user name and password settings used for uploads.
- Display status information about the diagnostics run previously.

To customize Remote HP PC Hardware Diagnostics UEFI settings, follow these steps:

1. Turn on or restart the computer, and when the HP logo appears, press **f10** to enter Computer Setup.
2. Select **Advanced**, and then select **Settings**.

3. Make your customization selections.
4. Select **Main**, and then **Save Changes and Exit** to save your settings.

Your changes take effect when the computer restarts.

8 Backing up, restoring, and recovering

This chapter provides information about the following processes, which are standard procedure for most products:

- **Backing up your personal information**—You can use Windows tools to back up your personal information (see [Using Windows tools on page 73](#)).
- **Creating a restore point**—You can use Windows tools to create a restore point (see [Using Windows tools on page 73](#)).
- **Creating recovery media** (select products only)—You can use HP Recovery Manager or HP Cloud Recovery Download Tool (select products only) to create recovery media (see [Creating HP Recovery media \(select products only\) on page 73](#)).
- **Restoring and recovery**—Windows offers several options for restoring from backup, refreshing the computer, and resetting the computer to its original state (see [Using Windows tools on page 73](#)).
- **Removing the Recovery Partition**—To remove the Recovery partition to reclaim hard drive space (select products only), select the **Remove Recovery Partition** option of HP Recovery Manager. For more information, see [Removing the HP Recovery partition \(select products only\) on page 77](#).

Using Windows tools

 **IMPORTANT:** Windows is the only option that allows you to back up your personal information. Schedule regular backups to avoid information loss.

You can use Windows tools to back up personal information and create system restore points and recovery media, allowing you to restore from backup, refresh the computer, and reset the computer to its original state.

 **NOTE:** If computer storage is 32 GB or less, Microsoft System Restore is disabled by default.

For more information and steps, see the Get Help app.

- ▲ Select the **Start** button, and then select the **Get Help** app.

 **NOTE:** You must be connected to the Internet to access the Get Help app.

Creating HP Recovery media (select products only)

After you have successfully set up the computer, use HP Recovery Manager to create a backup of the HP Recovery partition on the computer. This backup is called HP Recovery media. In cases where the hard drive is corrupted or has been replaced, the HP Recovery media can be used to reinstall the original operating system.

To check for the presence of the Recovery partition in addition to the Windows partition, right-click the **Start** button, select **File Explorer**, and then select **This PC**.

 **NOTE:** If your computer does not list the Recovery partition in addition to the Windows partition, contact support to obtain recovery discs. Go to <http://www.hp.com/support>, select your country or region, and then follow the on-screen instructions.

On select products, you can use the HP Cloud Recovery Download Tool to create HP Recovery media on a bootable USB flash drive. For more information, see [Using the HP Cloud Recovery Download Tool to create recovery media on page 74](#).

Using HP Recovery Manager to create recovery media

 **NOTE:** If you cannot create recovery media yourself, contact support to obtain recovery discs. Go to <http://www.hp.com/support>, select your country or region, and then follow the on-screen instructions.

Before you begin

Before you begin, note the following:

- Only one set of recovery media can be created. Handle these recovery tools carefully, and keep them in a safe place.
- HP Recovery Manager examines the computer and determines the required media storage capacity.
- To create recovery media, use one of the following options:

 **NOTE:** If the computer does not have a recovery partition, HP Recovery Manager displays the Windows Create a Recovery Drive feature. Follow the on-screen instructions to create a recovery image on a blank USB flash drive or hard drive.

- If your computer has an optical drive with DVD writer capability, be sure to use only high-quality blank DVD-R, DVD+R, DVD-R DL, or DVD+R DL discs. Do not use rewritable discs such as CD±RW, DVD±RW, double-layer DVD±RW, or BD-RE (rewritable Blu-ray) discs, which are not compatible with HP Recovery Manager software.
- If your computer does not include an integrated optical drive with DVD writer capability, you can use an external optical drive (purchased separately) to create recovery discs, as described above. If an external optical drive is used, you must connect it directly to a USB port on the computer. It cannot be connected to a USB port on an external device, such as a USB hub.
- To create a recovery flash drive, use a high-quality blank USB flash drive.
- Be sure that the computer is connected to AC power before you begin creating the recovery media.
- The creation process can take an hour or more. Do not interrupt this process.
- If necessary, you can exit the program before you have finished creating all of the recovery media. HP Recovery Manager will finish the current DVD or flash drive. The next time you start HP Recovery Manager, you will be prompted to continue.

Creating the recovery media

To create HP Recovery media using HP Recovery Manager:

 **IMPORTANT:** For a tablet with a detachable keyboard, connect the tablet to the keyboard base before beginning these steps.

1. Type `recovery` in the taskbar search box, and then select **HP Recovery Manager**.
2. Select **Create recovery media**, and then follow the on-screen instructions.

If you need to recover the system, see [Recovering using HP Recovery Manager on page 75](#).

Using the HP Cloud Recovery Download Tool to create recovery media

To create HP Recovery media using the HP Cloud Recovery Download Tool:

1. Go to <http://www.hp.com/support>.
2. Select **Software and Drivers**, and then follow the on-screen instructions.

Restoring and recovery

Restoring and recovery can be performed using one or more of the following options: Windows tools, HP Recovery Manager, or the HP Recovery partition.

 **IMPORTANT:** Not all methods are available on all products.

Restoring, resetting, and refreshing using Windows tools

Windows offers several options for restoring, resetting, and refreshing the computer. For details, see [Using Windows tools on page 73](#).

Restoring using HP Recovery Manager and the HP Recovery partition

You can use HP Recovery Manager and the HP Recovery partition (select products only) to restore the computer to the original factory state:

- **Resolving problems with preinstalled applications or drivers**—To correct a problem with a preinstalled application or driver:
 1. Type `recovery` in the taskbar search box, and then select **HP Recovery Manager**.
 2. Select **Reinstall drivers and/or applications**, and then follow the on-screen instructions.
- **Using System Recovery**—To recover the Windows partition to original factory content, select the **System Recovery** option from the HP Recovery partition (select products only) or use the HP Recovery media. For more information, see [Recovering using HP Recovery Manager on page 75](#). If you have not already created recovery media, see [Creating HP Recovery media \(select products only\) on page 73](#).
- **Using Factory Reset** (select products only)—Restores the computer to its original factory state by deleting all information from the hard drive and recreating the partitions and then reinstalling the operating system and the software that was installed at the factory (select products only). To use the **Factory Reset** option, you must use HP Recovery media. If you have not already created recovery media, see [Creating HP Recovery media \(select products only\) on page 73](#).

 **NOTE:** If you have replaced the hard drive in the computer, you can use the Factory Reset option to install the operating system and the software that was installed at the factory.

Recovering using HP Recovery Manager

You can use HP Recovery Manager software to recover the computer to its original factory state by using the HP Recovery media that you either created or that you obtained from HP, or by using the HP Recovery partition (select products only).

If you have not already created HP Recovery media, see [Creating HP Recovery media \(select products only\) on page 73](#).

 **IMPORTANT:** HP Recovery Manager does not automatically provide backups of your personal data. Before beginning recovery, back up any personal data that you want to retain. See [Using Windows tools on page 73](#).

IMPORTANT: Recovery through HP Recovery Manager should be used as a final attempt to correct computer issues.

 **NOTE:** When you start the recovery process, only the options available for your computer are displayed.

Before you begin, note the following:

- HP Recovery Manager recovers only software that was installed at the factory. For software not provided with this computer, you must either download the software from the manufacturer's website or reinstall the software from the media provided by the manufacturer.
- If the computer hard drive fails, HP Recovery media must be used. This media is created using HP Recovery Manager. See [Creating HP Recovery media \(select products only\) on page 73](#).
- If your computer does not allow the creation of HP Recovery media or if the HP Recovery media does not work, contact support to obtain recovery media. Go to <http://www.hp.com/support>, select your country or region, and then follow the on-screen instructions.

Recovering using the HP Recovery partition (select products only)

The HP Recovery partition allows you to perform a system recovery without recovery discs or a recovery USB flash drive. This type of recovery can be used only if the hard drive is still working.

The HP Recovery partition (select products only) allows System Recovery only.

To start HP Recovery Manager from the HP Recovery partition:



IMPORTANT: For a tablet with a detachable keyboard, connect the tablet to the keyboard base before beginning these steps (select products only).

1. Type `recovery` in the taskbar search box, select **HP Recovery Manager**, and then select **Windows Recovery Environment**.

– or –

For computers or tablets with keyboards attached:

- ▲ Press **f11** while the computer boots, or press and hold **f11** as you press the power button.

For tablets without keyboards:

- ▲ Turn on or restart the tablet, quickly hold down the volume up button, and then select **f11**.

2. Select **Troubleshoot** from the boot options menu.
3. Select **Recovery Manager**, and then follow the on-screen instructions.



NOTE: If your computer does not automatically restart in HP Recovery Manager, change the computer boot order, and then follow the on-screen instructions. See [Changing the computer boot order on page 77](#).

Recovering using HP Recovery media

If your computer does not have an HP Recovery partition or if the hard drive is not working properly, you can use HP Recovery media to recover the original operating system and software programs that were installed at the factory.

- ▲ Insert the HP Recovery media, and then restart the computer.



NOTE: If your computer does not automatically restart in HP Recovery Manager, change the computer boot order, and then follow the on-screen instructions. See [Changing the computer boot order on page 77](#).

Changing the computer boot order

If your computer does not restart in HP Recovery Manager, you can change the computer boot order. This is the order of devices listed in BIOS where the computer looks for startup information. You can change the selection to an optical drive or a USB flash drive, depending on the location of your HP Recovery media.

To change the boot order:

 **IMPORTANT:** For a tablet with a detachable keyboard, connect the tablet to the keyboard base before beginning these steps.

1. Insert the HP Recovery media.
2. Access the system **Startup** menu.

For computers or tablets with keyboards attached:

- ▲ Turn on or restart the computer or tablet, quickly press **esc**, and then press **f9** for boot options.

For tablets without keyboards:

- ▲ Turn on or restart the tablet, quickly hold down the volume up button, and then select **f9**.

– or –

Turn on or restart the tablet, quickly hold down the volume down button, and then select **f9**.

3. Select the optical drive or USB flash drive from which you want to boot, and then follow the on-screen instructions.

Removing the HP Recovery partition (select products only)

HP Recovery Manager software allows you to remove the HP Recovery partition (select products only) to free up hard drive space.

 **IMPORTANT:** After you remove the HP Recovery partition, you will not be able to perform System Recovery or create HP Recovery media. Before removing the Recovery partition, create HP Recovery media. See [Creating HP Recovery media \(select products only\) on page 73](#).

Follow these steps to remove the HP Recovery partition:

1. Type `recovery` in the taskbar search box, and then select **HP Recovery Manager**.
2. Select **Remove Recovery Partition**, and then follow the on-screen instructions.

9 Specifications

	Metric	U.S.
Computer dimensions		
Width	323.5 mm	12.74 in
Depth	224.2 mm	8.83 in
Height		
HD display	20.5 mm	0.81 in
FHD display	19.7 mm	0.78 in
Weight		
Full-featured models; UMA graphics; SSD models	1599 g	3.53 lbs
Full-featured models+; UMA graphics; SSD models	1647 g	3.63 lbs
Full-featured models; UMA graphics; HDD models	1689 g	3.72 lbs
Full-featured models+; UMA graphics; HDD models	1738 g	3.83 lbs
Full-featured models; discrete graphics; SSD models	1609 g	3.55 lbs
Full-featured models+; discrete graphics; SSD models	1658 g	3.66 lbs
Full-featured models; discrete graphics; HDD models	1699 g	3.75 lbs
Full-featured models+; discrete graphics; HDD models	1748 g	3.85 lbs
Temperature		
Operating	5°C to 35°C	41°F to 95°F
Nonoperating	-20°C to 60°C	-4°F to 140°F
Relative humidity (noncondensing)		
Operating	10% to 90%	
Nonoperating	5% to 95%	
Maximum altitude (unpressurized)		
Operating	-15 m to 3,048 m	-50 ft to 10,000 ft
Nonoperating	-15 m to 12,192 m	-50 ft to 40,000 ft
NOTE: Applicable product safety standards specify thermal limits for plastic surfaces. The device operates well within this range of temperatures.		

10 Power cord set requirements

The wide-range input feature of the computer permits it to operate from any line voltage from 100 to 120 volts AC, or from 220 to 240 volts AC.

The 3-conductor power cord set included with the computer meets the requirements for use in the country or region where the equipment is purchased.

Power cord sets for use in other countries and regions must meet the requirements of the country or region where the computer is used.

Requirements for all countries

The following requirements are applicable to all countries and regions:

- The length of the power cord set must be at least 1.0 m (3.3 ft) and no more than 2.0 m (6.5 ft).
- All power cord sets must be approved by an acceptable accredited agency responsible for evaluation in the country or region where the power cord set will be used.
- The power cord sets must have a minimum current capacity of 10 amps and a nominal voltage rating of 125 or 250 V AC, as required by the power system of each country or region.
- The appliance coupler must meet the mechanical configuration of an EN 60 320/IEC 320 Standard Sheet C13 connector for mating with the appliance inlet on the back of the computer. Requirements for all countries 113

Requirements for specific countries and regions

Country/region	Accredited agency	Applicable note number
Australia	EANSW	1
Austria	OVE	1
Belgium	CEBC	1
Canada	CSA	2
Denmark	DEMKO	1
Finland	FIMKO	1
France	UTE	1
Germany	VDE	1
Italy	IMQ	1
Japan	METI	3
The Netherlands	KEMA	1
Norway	NEMKO	1
The People's Republic of China	COC	5

Country/region	Accredited agency	Applicable note number
South Korea	EK	4
Sweden	CEMKO	1
Switzerland	SEV	1
Taiwan	BSMI	4
The United Kingdom	BSI	1
The United States	UL	2

1. The flexible cord must be Type H05VV-F, 3-conductor, 1.0-mm² conductor size. Power cord set fittings (appliance coupler and wall plug) must bear the certification mark of the agency responsible for evaluation in the country or region where it will be used.
2. The flexible cord must be Type SPT-3 or equivalent, No. 18 AWG, 3-conductor. The wall plug must be a two-pole grounding type with a NEMA 5-15P (15 A, 125 V) or NEMA 6-15P (15 A, 250 V) configuration.
3. The appliance coupler, flexible cord, and wall plug must bear a “T” mark and registration number in accordance with the Japanese Dentori Law. The flexible cord must be Type VCT or VCTF, 3-conductor, 1.00-mm² conductor size. The wall plug must be a two-pole grounding type with a Japanese Industrial Standard C8303 (7 A, 125 V) configuration.
4. The flexible cord must be Type RVV, 3-conductor, 0.75-mm² conductor size. Power cord set fittings (appliance coupler and wall plug) must bear the certification mark of the agency responsible for evaluation in the country or region where it will be used.
5. The flexible cord must be Type VCTF, 3-conductor, 0.75-mm² conductor size. Power cord set fittings (appliance coupler and wall plug) must bear the certification mark of the agency responsible for evaluation in the country or region where it will be used.

11 Recycling

When a non-rechargeable or rechargeable battery has reached the end of its useful life, do not dispose of the battery in general household waste. Follow the local laws and regulations in your area for battery disposal.

HP encourages customers to recycle used electronic hardware, HP original print cartridges, and rechargeable batteries. For more information about recycling programs, see the HP Web site at <http://www.hp.com/recycle>.

Index

- A**
 - AC adapter and battery light, identifying 7
 - AC adapter, spare part numbers 26
 - action keys
 - airplane mode 14
 - help 14
 - identifying 13, 14
 - keyboard backlight 14
 - mute 14
 - next track 14
 - pause 14
 - play 14
 - privacy screen 14
 - screen brightness 14
 - speaker volume 14
 - stop 14
 - switch screen image 14
 - using 14
 - airplane mode key 14
 - audio
 - adjusting volume 14
 - audio, product description 3
 - audio-out (headphone)/audio-in (microphone) combo jack, identifying 7
- B**
 - backup, creating 73
 - backups 73
 - base enclosure, spare part numbers 22
 - battery
 - removal 35
 - spare part number 20, 35
 - BIOS
 - determining version 66
 - downloading an update 67
 - starting the Setup Utility 66
 - updating 66
 - Bluetooth label 16
 - boot order, changing 77
 - bottom components 15
 - bottom cover
 - removal 33
 - spare part number 33
 - buttons
 - left TouchPad 10
 - power 7
 - right TouchPad 10
- C**
 - cables 22
 - cables, service considerations 27
 - camera
 - identifying 9, 12
 - removal 51
 - spare part number 51
 - camera light, identifying 9
 - camera, product description 2
 - caps lock light, identifying 11
 - chipset, product description 1
 - components
 - bottom 15
 - display 9
 - keyboard area 10
 - left side 7
 - right side 6
 - computer major components 18
 - connector, power 7
 - connectors, service considerations 27
- D**
 - display assembly
 - removal 52
 - spare part numbers 52
 - display components 9
 - display panel, product description 1
 - drive light, identifying 6
 - drives 23
 - precautions 28
 - preventing damage 28
- E**
 - electrostatic discharge 29
 - equipment guidelines 31
 - esc key, identifying 13
- F**
 - fan/heat sink assembly
 - removal 61
 - spare part numbers 21, 61
 - fingerprint reader board
 - removal 47
 - fingerprint reader, identifying 6
 - fn key, identifying 13
- G**
 - Get Help in Windows 10 action key 14
 - graphics, product description 1
 - grounding guidelines 29
 - guidelines
 - equipment 31
 - grounding 29
 - packaging 30
 - transporting 30
 - workstation 30
- H**
 - hard drive
 - product description 2
 - removal 40
 - spare part numbers 19, 40
 - hard drive cable
 - spare part number 40
 - hard drive foil
 - removal 42
 - spare part number 40
 - hard drive rubber sleeve
 - removal 41
 - spare part number 40
 - HDMI port
 - identifying 6
 - HDMI-to-VGA adapter, spare part number 26
 - HP PC Hardware Diagnostics UEFI
 - downloading 70
 - starting 70
 - using 69
 - HP PC Hardware Diagnostics Windows
 - downloading 68

- installing 69
- using 68
- HP Recovery Manager
 - correcting boot problems 77
 - starting 76
- HP Recovery media
 - recovery 76
 - using 74
- HP Recovery partition
 - recovery 76
 - removing 77

I
internal microphones, identifying 9

J
jacks

- audio-out (headphone)/audio-in (microphone) 7

K
keyboard

- removal 19, 65
- spare part number 19, 65

keyboard backlight action key 14
keyboard, product description 4
keys

- action 13
- airplane mode 14
- esc 13
- fn 13
- Windows 13

L
labels

- Bluetooth 16
- regulatory 16
- serial number 16
- service 16
- wireless certification 16
- WLAN 16

left side components 7
lights

- AC adapter and battery 7
- camera 9
- caps lock 11
- drive 6
- mute 11
- power 8

M
mass storage devices 23
memory cover

- removal 43
- spare part number 21

memory module

- product description 2
- removal 43
- spare part numbers 21, 43

memory module bracket

- spare part number 43

microphone

- product description 2, 3

MicroSD memory card reader, identifying 6
minimized image recovery 76
minimized image, creating 75
miscellaneous parts kit 24
model name 1
mute light, identifying 11
mute volume action key 14

N
next track action key 14

O
operating system, product description 4
Optane memory module

- removal 37
- spare part number 37
- spare part numbers 37

optical drive

- product description 2

optical drive, spare part number 26
original system recovery 75

P
packaging guidelines 30
pause action key 14
plastic parts, service considerations 27
play action key 14
ports

- HDMI 6
- product description 3
- USB SuperSpeed 6, 7
- USB Type-C 6

power button board

- removal 46
- spare part number 20, 46, 47

- power button, identifying 7
- power connector
 - identifying 7
- power connector cable
 - removal 55
 - spare part number 21, 55
- power cord
 - set requirements 79
- power lights, identifying 8
- power requirements, product description 4
- privacy screen action key 14
- privacy screen action key, identifying 14
- processor, product description 1
- product description
 - audio 3
 - camera 2
 - chipset 1
 - display panel 1
 - external memory cards 3
 - graphics 1
 - hard drive 2
 - internal card expansion 3
 - keyboard 4
 - memory module 2
 - microphone 3
 - operating system 4
 - optical drive 2
 - ports 3
 - power requirements 4
 - processors 1
 - product name 1
 - security 4
 - sensors 3
 - serviceability 5
 - solid-state drive 2
 - storage 2
 - TouchPad 4
 - wireless 3
- product name 1
- product name and number, computer 16

R
recovery 73

- discs 74, 76
- HP Recovery Manager 75
- HP Recovery partition 75
- media 76

- starting 76
 - supported discs 74
 - system 75
 - USB flash drive 76
 - using HP Recovery media 74
 - recovery media
 - creating using HP Cloud Recovery Download Tool 74
 - creating using HP Recovery Manager 74
 - creating using Windows tools 73
 - discs 74
 - HP Recovery partition 73
 - USB flash drive 74
 - using 74
 - recovery partition, removing 77
 - regulatory information
 - regulatory label 16
 - wireless certification labels 16
 - Remote HP PC Hardware Diagnostics
 - UEFI settings
 - customizing 71
 - using 71
 - removal/replacement
 - procedures 32
 - restoring 73
 - right side components 6
 - Rubber Kit, spare part number 21, 33
- S**
- screen brightness action keys 14
 - Screw Kit, spare part number 26
 - security cable slot, identifying 8
 - security, product description 4
 - sensors, product description 3
 - serial number, computer 16
 - service considerations
 - cables 27
 - connectors 27
 - plastic parts 27
 - service labels, locating 16
 - serviceability, product description 5
 - slots
 - memory card reader 6
 - security cable 8
 - solid-state drive
 - product description 2
 - removal 36
 - spare part numbers 21, 36
 - speaker volume action keys 14
 - speakers
 - identifying 12
 - removal 50
 - spare part number 21, 50
 - special keys, using 13
 - stop action key 14
 - storage, product description 2
 - stylus, spare part number 26
 - supported discs, recovery 74
 - switch screen image action key 14
 - system board
 - removal 56
 - spare part numbers 20, 56
 - system recovery 75
 - system restore point, creating 73
- T**
- tools required 27
 - top cover
 - removal 19, 65
 - spare part number 19, 65
 - TouchPad
 - removal 48
 - spare part number 19, 48
 - TouchPad bracket
 - spare part number 19, 48
 - TouchPad buttons
 - identifying 10
 - TouchPad cable
 - spare part number 19, 48
 - TouchPad zone, identifying 10
 - TouchPad, product description 4
 - transporting guidelines 30
 - traveling with the computer 16
- U**
- USB SuperSpeed port, identifying 6
 - USB Type-C port, identifying 6
 - USB-to-Gigabit RJ45 adapter, spare part number 26
 - USB/audio board
 - removal 60
 - spare part number 20, 60
 - USB-C-to-USB-A dongle, spare part number 26
- V**
- vents, identifying 7, 15
- W**
- Windows
 - backup 73
 - recovery media 73
 - system restore point 73
 - Windows key, identifying 13
 - Windows tools, using 73
 - wireless certification label 16
 - wireless, product description 3
 - WLAN antennas, identifying 9
 - WLAN device 16
 - WLAN label 16
 - WLAN module
 - removal 38
 - spare part numbers 21, 38
 - workstation guidelines 30
- volume**
- adjusting 14
 - mute 14
 - volume button, identifying 6