

ESPRIMO X913 / X913-T
FUTRO X913 / X913-T

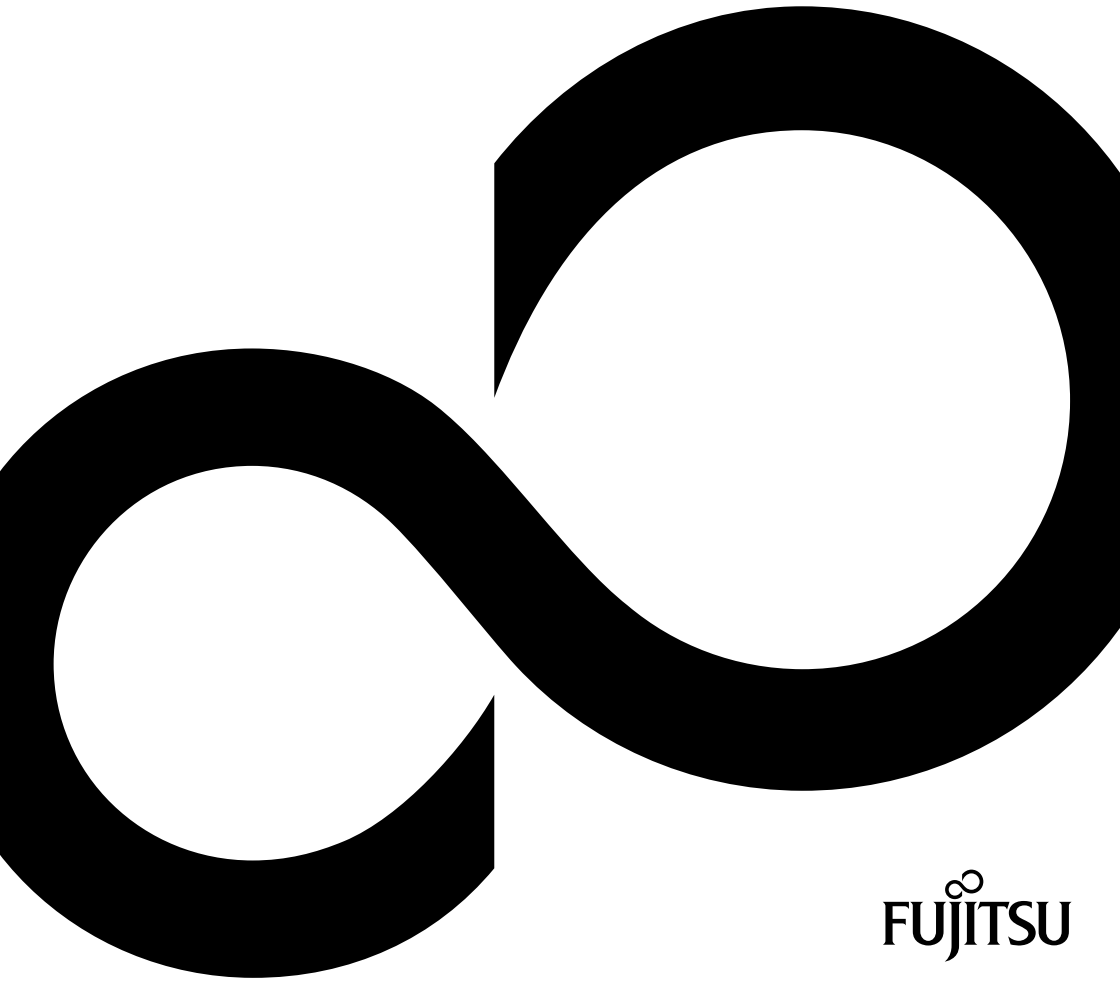

Thank you for buying an innovative product from Fujitsu.

Latest information about our products, useful tips, updates etc. is available on our website: ["http://www.fujitsu.com/fts/"](http://www.fujitsu.com/fts/)

You can find driver updates at: ["http://support.ts.fujitsu.com/download"](http://support.ts.fujitsu.com/download)

Should you have any technical questions, please contact:

- our Hotline/Service Desk (see Service Desk list or from the Internet at: ["http://support.ts.fujitsu.com/contact/servicedesk"](http://support.ts.fujitsu.com/contact/servicedesk))
- Your sales partner
- Your sales office

We hope you enjoy using your new Fujitsu system!



Published by / Contact address in the EU

Fujitsu Technology Solutions GmbH

Mies-van-der-Rohe-Straße 8

80807 Munich, Germany

["http://www.fujitsu.com/fts/"](http://www.fujitsu.com/fts/)

Copyright

© Fujitsu Technology Solutions GmbH 2013. All rights reserved.

Publication Date

05/2013

Order No.: A26361-K1065-Z320-1-7619, edition 3

ESPRIMO X913 / X913-T

FUTRO X913 / X913-T

Operating Manual

Your ESPRIMO / FUTRO	5
Ports and operating elements	7
Important notes	12
Getting started	19
Operation	31
Troubleshooting and tips	52
Technical data	58
Index	59

Remarks

Information on the product description meets the design specifications of Fujitsu and is provided for comparison purposes. Several factors may cause the actual results to differ. Technical data is subject to change without prior notification. Fujitsu rejects any responsibility with regard to technical or editorial mistakes or omissions.

Trademarks

Fujitsu, the Fujitsu logo and FUTRO are registered trademarks of Fujitsu Limited or its subsidiaries in the United States of America and other countries.

Kensington and Microsaver are registered trademarks of ACCO Brands.

Microsoft and Windows are trademarks or registered trademarks of the Microsoft Corporation in the United States and/or other countries.

This product is protected by certain intellectual property rights of Microsoft. Use or distribution of such technology outside of this product is prohibited without a license from Microsoft.

Teradici and PColP are trademarks of the Teradici Corporation in the United States of America and/or other countries.

All other trademarks specified here are the property of their respective owners.

Copyright

No part of this publication may be copied, reproduced or translated without the prior written consent of Fujitsu.

No part of this publication may be saved or transferred by any electronic means without the written approval of Fujitsu.

Contents

Your ESPRIMO / FUTRO	5
Validity of the Reference Manual	5
Further information	5
Notational conventions	6
Ports and operating elements	7
Front	7
Left side	8
Right-hand side	9
Rear side (FUTRO)	10
Rear side (ESPRIMO)	11
Important notes	12
General safety notes	12
Safety notes for the system	13
Power cable	14
Transporting the device	14
Cleaning the device	14
Energy saving, disposal and recycling	14
Explanatory information about standard ISO 9241-307	15
CE marking	16
FCC Compliance Statement	17
FCC Class B Compliance Statement	17
FCC Radiation Exposure Statement	17
Disposal and recycling	18
Getting started	19
Unpacking and checking the delivery	19
Steps for initial setup	19
Setting up the device	20
Setting up an ergonomic video workstation	20
Setting up the PC	22
Adjusting height	23
Adjusting the inclination	23
Connecting the power cable	24
Connecting external devices	25
Connecting the cables	25
Disconnecting the cables	25
Ports on the device	26
Connecting a USB mouse	27
Connecting a USB keyboard	27
Connecting external devices to the USB ports	27
Connecting an external monitor	28
Connecting external audio devices	28
Switching on for the first time: installing the software	29
Switching the device on	30
Installing the software	30
Operation	31
Switch the device on	31
Switching off the device	31
Activating power-saving mode	31

LCD screen	32
Changing the monitor settings with the buttons of the control panel	32
Changing the monitor settings using the OSD menu	34
Adjusting the brightness and contrast	35
Selecting the application mode	36
Adjusting the picture size and position	36
Setting colour temperature and colours	36
Setting functions	37
Displaying information	37
Notes on ergonomic colour adjustment	38
Preset operating modes	38
Most frequent operating modes	39
Indicators on the device	40
Keyboard	41
Important keys and keyboard shortcuts	41
Webcam module (optional)	43
Your webcam module	43
Presence sensor	45
Wireless LAN/Bluetooth radio components (optional)	46
Switching the wireless components on and off	46
Power over Ethernet module for FUTRO X913/X913-T (optional)	47
Settings in BIOS Setup Utility	48
Starting the BIOS Setup Utility	48
Operating BIOS Setup Utility	49
Exiting BIOS Setup Utility	49
Property and data protection	49
Using the Security Lock	49
BIOS Setup security functions	50
SmartCard reader (optional)	51
Troubleshooting and tips	52
Help if problems occur	52
Troubleshooting	52
Power-on indicator remains unlit after you have switched on your device	52
The device cannot be switched off with the ON/OFF switch.	53
Monitor remains blank	53
The external monitor remains blank	54
The external monitor is blank or the image is unstable	54
No mouse pointer displayed on the screen	55
Time and/or date is not correct	55
SmartCard reader is not recognised.	55
SmartCard PIN forgotten	55
SmartCard lost	56
User and/or supervisor SmartCard lost	56
Error messages on the screen	56
Installing new software	56
Restoring the hard disk contents	56
Tips	57
Technical data	58
Index	59

Your ESPRIMO / FUTRO

... is available with various configuration levels which differ in terms of hardware and software equipment.

This manual tells you how to start using your device and how to operate it in daily use. This manual applies for all configuration levels. Depending on the chosen configuration level, some of the hardware components described may not be available on your PC. Please also read the notes about your operating system.

Depending on the selected configuration, the operating system is preinstalled on your hard disk.

Further information on this device is provided:

- in the "Quick Start Guide" poster
- in the "Safety/regulations" manual
- in the "Warranty" manual
- in the operating manual for the monitor
- in the manual for the mainboard
- in your operating system documentation
- in the information files (e.g. *.PDF, *.HTML, *.DOC, *.CHM, *.TXT, *.HLP)



Some of the manuals listed can be found in electronic form on the "Drivers & Utilities" DVD.

You can access and view the required information using the *Acrobat Reader* program, which is also included on the DVD. You can of course also print out a copy of the manual if you prefer.

Validity of the Reference Manual

This Reference Manual is valid for the following systems:







- ESPRIMO X913
- ESPRIMO X913-T
- FUTRO X913
- FUTRO X913-T

Further information

For ergonomic reasons, we recommend a screen resolution of 1920 x 1080 pixels.

Because of the technology used (active matrix) an LCD monitor provides a totally flicker-free picture even with a refresh rate of 60 Hz.

Notational conventions

	Pay particular attention to text marked with this symbol. Failure to observe these warnings could pose a risk to health, damage the device or lead to loss of data. The warranty will be invalidated if the device becomes defective through failure to observe these warnings.
	Indicates important information for the proper use of the device.
	Indicates an activity that must be performed
	Indicates a result
This font	indicates data entered using the keyboard in a program dialogue or at the command line, e.g. your password (Name123) or a command used to start a program (start.exe)
This font	indicates information that is displayed on the screen by a program, e.g.: Installation is complete.
<i>This font</i>	indicates <ul style="list-style-type: none"> • terms and texts used in a software interface, e.g.: Click on <i>Save</i> • names of programs or files, e.g. <i>Windows</i> or <i>setup.exe</i>.
"This font"	indicates <ul style="list-style-type: none"> • cross-references to another section, e.g. "Safety information" • cross-references to an external source, e.g. a web address: For more information, go to "http://www.fujitsu.com/fts" • Names of CDs, DVDs and titles or designations for other materials, e.g.: "CD/DVD Drivers & Utilities" or "Safety/Regulations" manual
	indicates a key on the keyboard, e.g: 
This font	indicates terms and texts that are emphasised or highlighted, e.g.: Do not switch off the device

Ports and operating elements

This chapter presents the individual hardware components of your device. This will provide you with an overview of the ports and operating elements on the device. Please familiarise yourself with these components before starting to work with your device.

Front

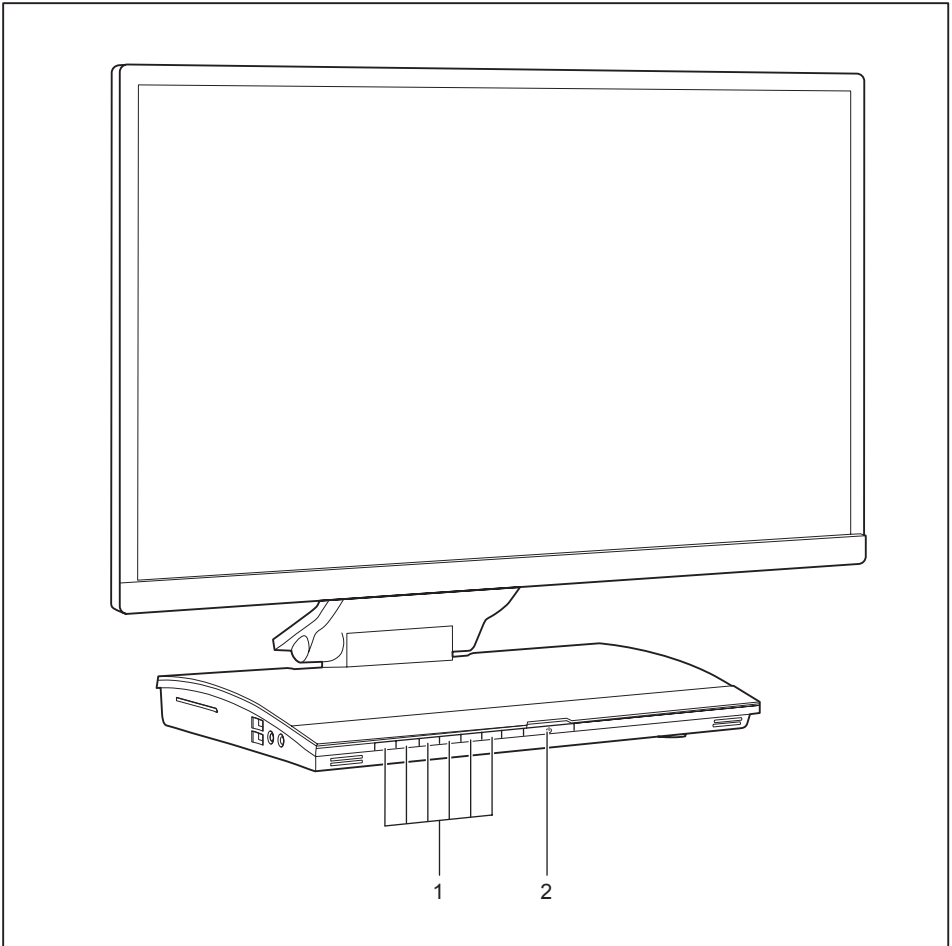

1 = Buttons for the OSD menu
(On-Screen-display)

2 = ON/OFF switch

Left side

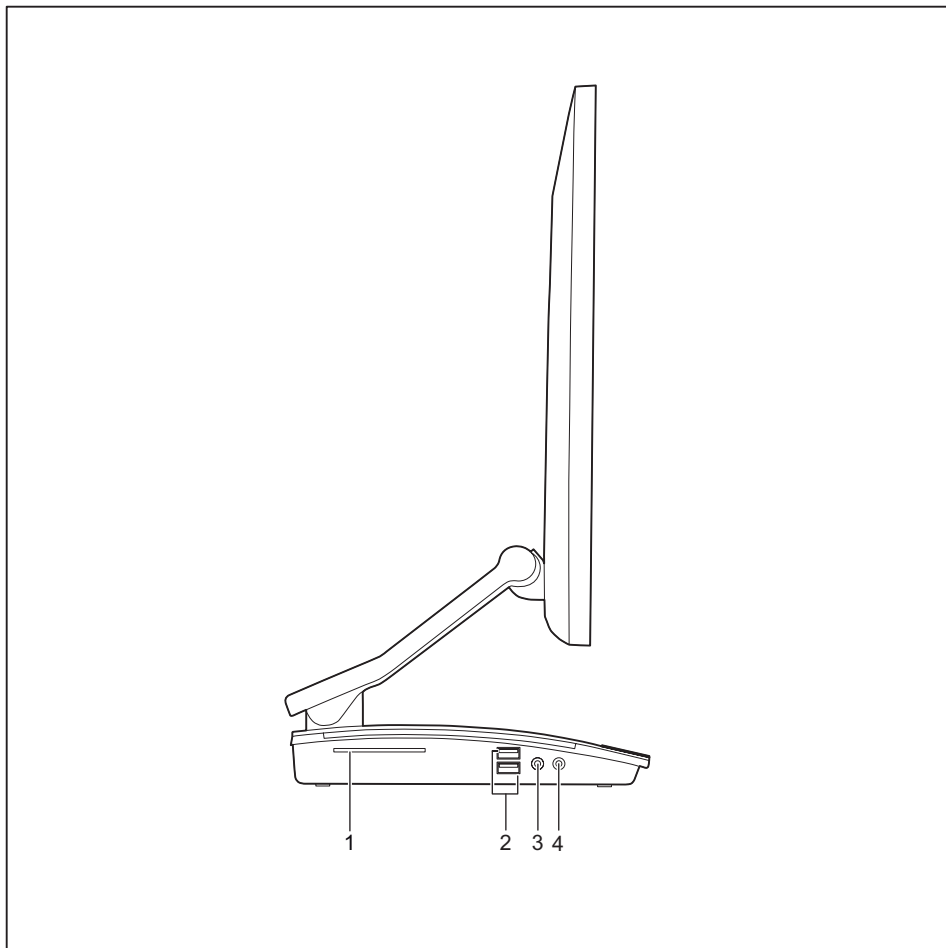

1 = SmartCard reader

2 = USB ports (ESPRIMO: USB 3.0,
FUTRO: USB 2.0)

3 = Microphone port

4 = Headphones port

Right-hand side

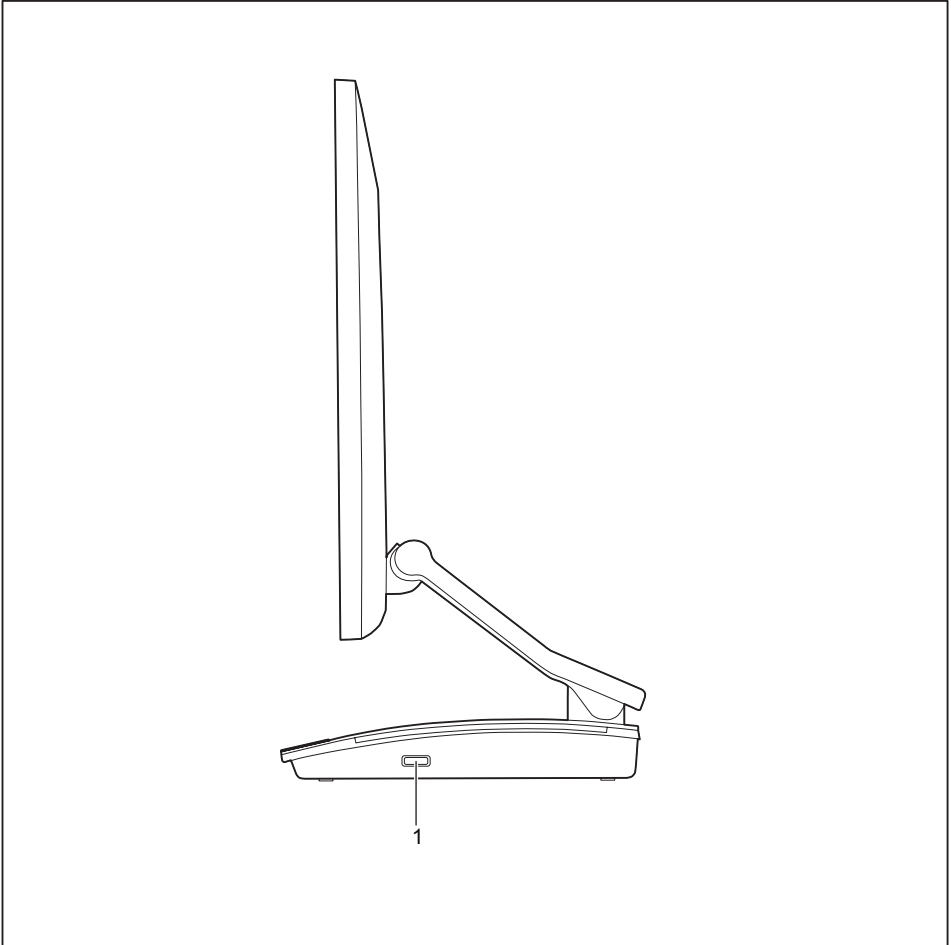

1 = Security Lock device / BIOS
Recovery button



The internal BIOS Recovery button can be actuated through the Security Lock device and protected against misuse by securing the Kensington lock.

Rear side (FUTRO)

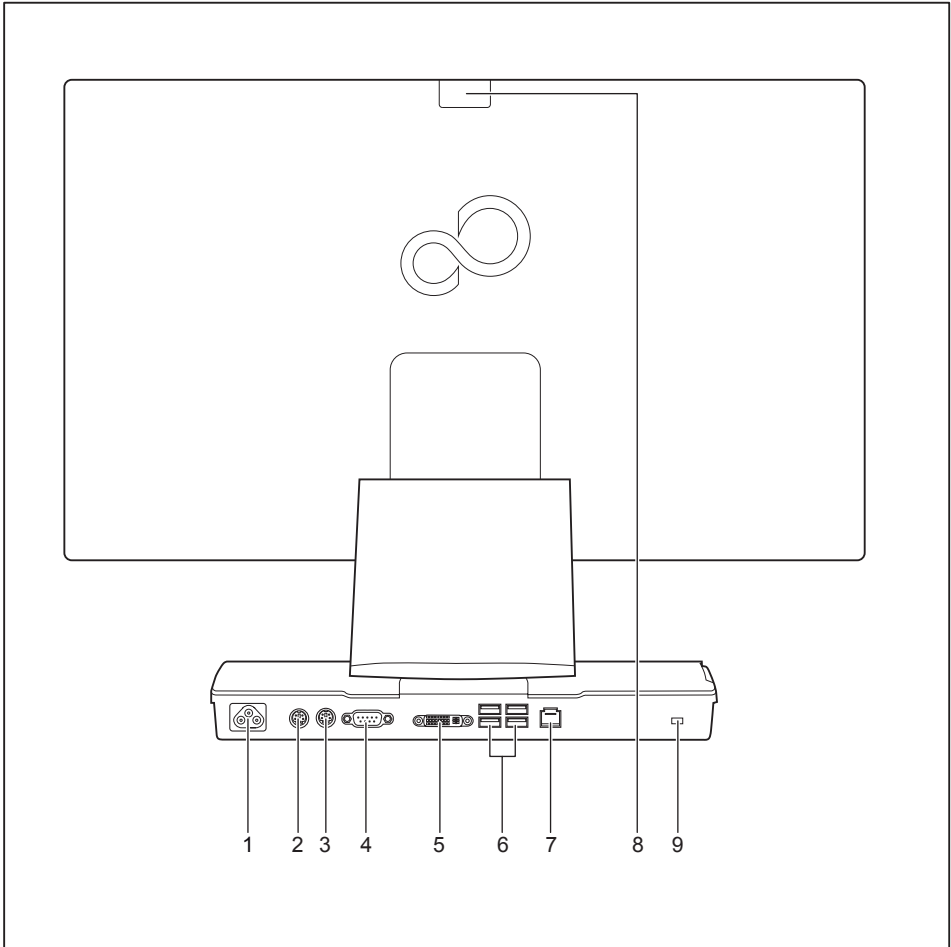

- 1 = Power connection (AC IN)
- 2 = PS/2 mouse port
- 3 = PS/2 keyboard port
- 4 = Serial port
- 5 = DVI-I monitor port

- 6 = USB ports (USB 2.0)
- 7 = LAN port
- 8 = Webcam slot device
- 9 = Security Lock device

Rear side (ESPRIMO)

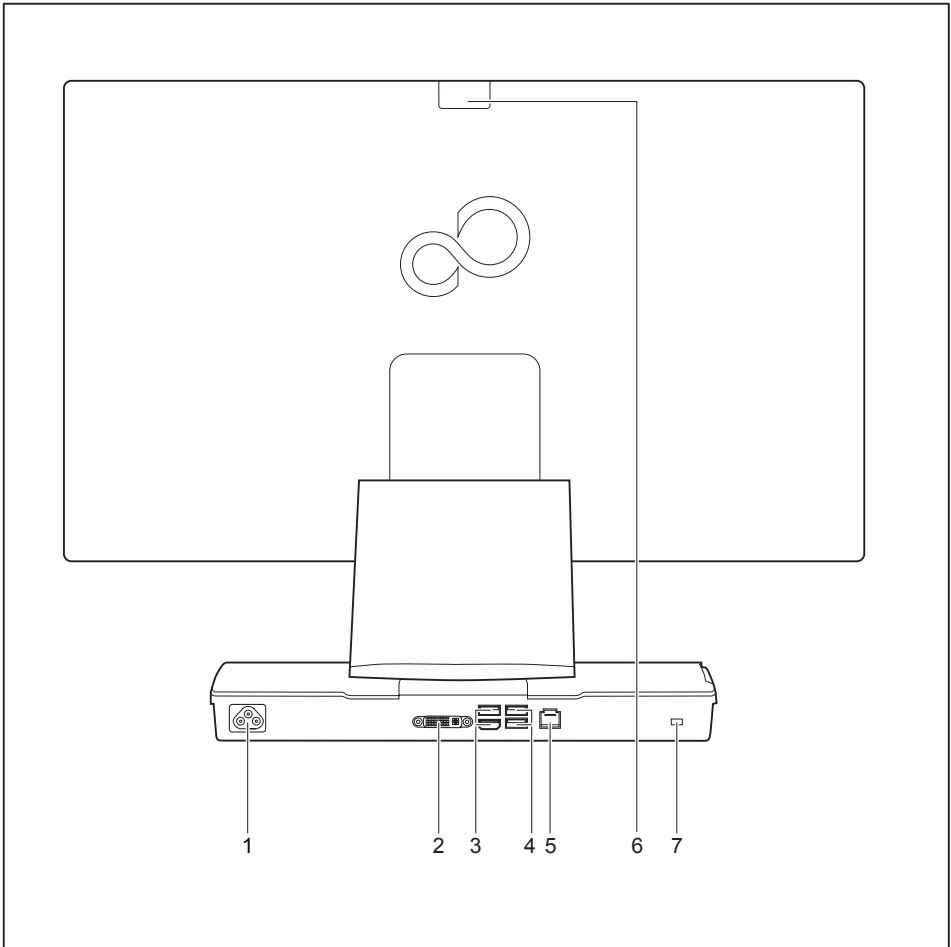

- 1 = Power connection (AC IN)
- 2 = DVI-I monitor port
- 3 = USB ports (USB 3.0)
- 4 = USB ports (USB 2.0)

- 5 = LAN port
- 6 = Webcam slot device
- 7 = Security Lock device

Important notes

In this chapter you will find information regarding safety which it is essential to take note of when working with your device.

General safety notes



Please note the information provided in the "Safety/regulations" manual and in the following safety notes.

When installing and operating the device, please observe the notes on environmental conditions in Chapter ["Technical data", Page 58](#) as well as the instructions in Chapter ["Getting started", Page 19](#).

When setting up the device, make sure there is clearance all around it so that the casing receives enough ventilation. In order to avoid overheating, do not cover the ventilation areas of the monitor or the device.

You must only operate the device if the rated voltage used by the device is set to the local mains voltage.

You must remove the power plug from the power socket so that the mains voltage is completely disconnected.

Caution, components in the system can get very hot.

The activities described in these instructions must always be performed with the greatest care.

Repairs to the device must only be performed by qualified technicians. Incorrect repairs could put the user at great risk or cause serious damage to the equipment (electric shock, risk of fire).

Only operate the device with the casing closed.

Safety notes for the system

This device complies with the relevant safety regulations for data processing equipment, including electronic office machines for use in an office environment. If you have any questions about whether the device can be used in the intended environment, please contact your sales office or our Service Desk.

- The display surface of the device is sensitive to pressure and scratches. You should therefore be careful with the display surface in order to avoid lasting damage (scratches).
- If the device is brought into the installation site from a cold environment, condensation can form. Before operating the device, wait until it is absolutely dry and has reached approximately the same temperature as the installation site.
- When installing and operating the device, please observe the notes on ambient conditions in ["Technical data", Page 58](#) and the instructions in ["Setting up an ergonomic video workstation", Page 20](#).
- To ensure sufficient ventilation, the air inlet and outlet openings of the device must be kept clear.
- The device automatically sets itself to the correct voltage within the range from 100 V to 240 V. Make sure that the local mains voltage is neither higher nor lower than this range.
- Ensure that the power socket on the device and the mains outlet are freely accessible.
- The ON/OFF switch does not disconnect the monitor from the mains voltage. To disconnect fully from the mains supply, disconnect the power plug from the socket.
- The device is equipped with a power cable that complies with safety standards.
- Use the supplied power cable only.
- Lay the cables in such a way that they do not create a hazard (danger of tripping) and cannot be damaged. When connecting the device, observe the relevant notes in chapter ["Connecting external devices", Page 25](#).
- No data transfer cables should be connected or disconnected during a thunderstorm.
- Make sure that no objects (e.g. jewellery chains, paper clips, etc.) or liquids get inside the device (danger of electric shock, short circuit).
- The device is not waterproof! Never immerse the device in water and protect it from spray water (rain, sea water).
- In an emergency (e.g. damaged casing, operation controls or cables, penetration of liquids or foreign matter), switch off the device, disconnect the power plug and contact your sales outlet or our Service Desk.
- Repairs to the device must only be performed by qualified technicians. Unauthorised opening and incorrect repair may greatly endanger the user (electric shock, fire risk).
- Only use the screen resolution settings and refresh rates specified in Chapter ["Technical data", Page 58](#). Otherwise you may damage the device. If you are in any doubt, contact your sales outlet or our Help Desk.
- Use a screen saver with moving images and activate the power management for your monitor to prevent still images from "burning in".
- We recommend that you place your device on a durable, non-slip surface. In view of the many different finishes and varnishes used on furniture, it is possible that the feet of the device may mark the surface they stand on.

Power cable

Use the supplied power cable only.

Use the following guidelines if it is necessary to replace the original cable set.

- The female/male receptacles of the cord set must meet IEC60320/CEE-22 requirements.
- The cable has to be HAR-certified or VDE-certified. The mark HAR or VDE will appear on the outer sheath.
- For devices which are mounted on a desk or table, type SVT or SJT cable sets may be used. For devices which sit on the floor, only SJT type cable sets may be used.
- The cable set must be selected according to the rated current for your device.
- If necessary, replace the original power cable with a regular grounded 3-core mains lead.

Transporting the device



Transport all parts separately in their original packaging or in a packaging which protects them from knocks and jolts, to the new site.

Do not unpack them until all transportation manoeuvres are completed.

If the device is brought from a cold environment into the room where it will be used, condensation may occur. To avoid damaging the device, wait until it has reached room temperature and is absolutely dry before initial startup.

Cleaning the device



Turn off all power and equipment switches and disconnect the power plug from the mains outlet.

Do not clean any interior parts yourself, leave this job to a service technician.

Do not use any cleaning agents that contain abrasives or may corrode plastic (alcohol, thinner or acetone).

Never clean the device with water! Water entering into the device could present a serious risk to users (e.g. electric shock).

Ensure that no liquid enters the system.

The surface of the monitor is sensitive to pressure and scratches. Clean it only using a soft, slightly moistened cloth.

The surface can be cleaned with a dry cloth. If particularly dirty, use a cloth that has been moistened in mild domestic detergent and then carefully wrung out.

Use disinfectant wipes to clean the keyboard and the mouse.

Energy saving, disposal and recycling

You can find information on these subjects in chapter "[Activating power-saving mode](#)", [Page 31](#), on the "Drivers & Utilities", the recovery DVD or on our website ("<http://www.fujitsu.com/fts/about/fts/environment-care/>").

Explanatory information about standard ISO 9241-307

Permanently unlit or lit pixels

Today's production techniques cannot guarantee an absolutely fault-free screen display. Depending on the total number of pixels (resolution), there may be a few constantly lit or unlit pixels or subpixels.

Pixel	A pixel consists of 3 subpixels, normally red, green and blue. A pixel is the smallest element that can be generated by complete functionality of the display.
Subpixel	A subpixel is a separately addressable internal structure within a pixel that enhances the pixel function.

The maximum permitted number of faulty pixels is stipulated in the international standard ISO 9241-307. In accordance with standard ISO 9241-3, LCD displays by Fujitsu comply with Class II for low resolutions and Class I for resolutions of 1680 x 1050 (1764000 pixel) and higher.

Examples:

A flat-screen monitor with a resolution of 1280 x 1024 has $1280 \times 1024 = 1310720$ pixels. Each pixel consists of three subpixels (red, green and blue), so there are almost 3.9 million subpixels in total. According to ISO 9241-3 (Class II), a maximum of 3 lit and 3 unlit pixels plus 7 lit or 13 unlit subpixels, or a corresponding combination, may be faulty (1 lit subpixel counts as two unlit subpixels).

A flat-screen monitor with a resolution of 1920 x 1080 has $1920 \times 1080 = 2073600$ pixels. Each pixel consists of three subpixels (red, green and blue), so there are almost 6.2 million subpixels in total. According to ISO 9241-3 (Class I), a maximum of 2 lit and 2 unlit pixels plus 5 lit or 10 unlit subpixels, or a corresponding combination, may be faulty (1 lit subpixel counts as two unlit subpixels).

CE marking

The shipped version of this device complies with the requirements of European Union directives 2004/108/EC "Elektromagnetische Verträglichkeit", 2006/95/EC "Niederspannungsrichtlinie" and 2009/125/EC "Ökodesign Richtlinie".

CE marking for devices with radio component

This equipment complies with the requirements of Directive 1999/5/EC of the European Parliament and Commission from 9 March, 1999 governing Radio and Telecommunications Equipment and mutual recognition of conformity.

This equipment can be used in the following countries:

Belgium	Bulgaria	Denmark	Germany
Estonia	Finland	France	Greece
UK	Ireland	Iceland	Italy
Croatia	Latvia	Liechtenstein	Lithuania
Luxembourg	Malta	Netherlands	Norway
Austria	Poland	Portugal	Rumania
Sweden	Switzerland	Slovakia	Slovenia
Spain	Czech Republic	Hungary	Cyprus
Turkey			

Contact the corresponding government office in the respective country for current information on possible operating restrictions. If your country is not included in the list, then please contact the corresponding supervisory authority as to whether the use of this product is permitted in your country.

Information on the "Ecodesign directive":

Regulation 1275/2008, based on the EU Ecodesign Directive (2009/125/EC), defines requirements for the power consumption of electrical and electronic domestic and office devices in stand-by and off mode. Please see chapter ["Activating power-saving mode", Page 31](#).

FCC Compliance Statement

If the device complies with the FCC regulations, the FCC sign can be found on the type rating plate.

FCC Class B Compliance Statement

DOC (INDUSTRY CANADA) NOTICES

Notice to Users of Radios and Television:

This class B digital apparatus complies with Canadian ICES-003.

The following statement applies to the products covered in this manual, unless otherwise specified herein. The statement for other products will appear in the accompanying documentation.

NOTE:

This equipment has been tested and found to comply with the limits for a "Class B" digital device, pursuant to Part 15 of the FCC rules and meets all requirements of the Canadian Interference-Causing Equipment Standard ICES-003 for digital apparatus. These limits are designed to provide reasonable protection against harmful interference in a residential installation. This equipment generates, uses and can radiate radio frequency energy and, if not installed and used in strict accordance with the instructions, may cause harmful interference to radio communications. However, there is no guarantee that interference will not occur in a particular installation. If this equipment does cause harmful interference to radio or television reception, which can be determined by turning the equipment off and on, the user is encouraged to try to correct the interference by one or more of the following measures:

- Reorient or relocate the receiving antenna.
- Increase the separation between equipment and the receiver.
- Connect the equipment into an outlet on a circuit different from that to which the receiver is connected.
- Consult the dealer or an experienced radio/TV technician for help.

Fujitsu is not responsible for any radio or television interference caused by unauthorized modifications of this equipment or the substitution or attachment of connecting cables and equipment other than those specified by Fujitsu. The correction of interferences caused by such unauthorized modification, substitution or attachment will be the responsibility of the user.

The use of shielded I/O cables is required when connecting this equipment to any and all optional peripheral or host devices. Failure to do so may violate FCC and ICES rules.

FCC Radiation Exposure Statement

This equipment complies with FCC radiation exposure limits set forth for an uncontrolled environment.

The transmitters in this device must not be co-located or operated in conjunction with any other antenna or transmitter.

To prevent radio interference to the licensed service, this device is intended to be operated indoors and away from windows to provide maximum shielding. Equipment (or its transmit antenna) that is installed outdoors is subject to licensing.

Users are not authorized to modify this product. Any modifications invalidate the warranty.

This equipment may not be modified, altered, or changed in any way without signed written permission from Fujitsu. Unauthorized modification will void the equipment authorization from the FCC and Industry Canada and the warranty.

Disposal and recycling

This device has been manufactured as far as possible from materials which can be recycled or disposed of in such a way that the environment is not damaged. The device may be taken back after use to be reused or recycled, provided that it is returned in a condition that befits its intended use. Any components not reclaimed will be disposed of in an environmentally acceptable manner.

The device must be disposed of in accordance with the local regulations for disposal of special waste.

If you have any questions on disposal, please contact your local sales office or our Service Desk, or contact one of the following directly:

Germany	Belgium	Switzerland
Fujitsu Technology Solutions GmbH Remarketing and Recycling D-33106 Paderborn Tel.: +49 5251 / 81 80 10 Fax: +49 5251 / 81 80 15 "http://fujitsu.com/fts/remarketing"	RECUPEL Boulevard Reyers, 80 B-1030 Brussels Tel.: +32 2 / 706 86 16 Fax: +32 2 / 706 86 13 E-Mail: info@recupel.be "http://www.recupel.be"	SWICO Schweizerischer Wirtschaftsverband der Informations-, Kommunikations- und Organisationstechnik A list of the SWICO acceptance locations can be found at: "http://www.swico.ch"
Asia	USA	
Taiwan: Environmental Protection Administration Executive Yuan R.O.C. "http://recycle.epa.gov.tw"	Fujitsu America, Inc. 1250E. Arques Avenue Sunnyvale, CA 94085 U.S.A. Phone No.: (408) 746-6000	

You can also find more information on this at ["http://www.fujitsu.com/fts/about/fts/environment-care/"](http://www.fujitsu.com/fts/about/fts/environment-care/).

Getting started



Please observe the safety information in the ["Important notes", Page 12](#) chapter.

Unpacking and checking the delivery



The display surface of the device is sensitive to pressure and scratches. Always hold the device by the casing!

It is recommended not to throw away the original packaging material! It may be required for reshipment at some later date.

The complete device package includes:

- one CD with software and documentation
- one Warranty Booklet
- one "Quick Start Guide"
- one "Safety" manual
- ▶ Unpack all the individual parts.
- ▶ Check the contents of the package for any visible damage caused during transport.
- ▶ Check whether the delivery conforms to the details in the delivery note.
- ▶ Should you discover that the delivery does not correspond to the delivery note, notify your local sales outlet immediately.

Steps for initial setup

Only a few steps are necessary to put your new device into operation for the first time:

- Select a location for device and set up device
- Check the voltage at the mains outlet and connect the device to an electrical outlet
- Switch the device on

You will learn more about the individual steps in the following sections.

External devices



If you have received other external devices in addition to your own device (e.g. a printer), do not connect these until after the initial installation. The following sections describe how to connect these external devices.

Setting up the device



When installing your device, please read the recommendations and safety notes in the "Safety/regulations" manual.

We recommend that you place your device on a surface which is not slippery. In view of the many different finishes and varnishes used on furniture, it is possible that the rubber feet will mark the surface they stand on.

Depending on the location of your device, bothersome vibrations and noises may occur. To prevent this, a distance of at least 10 mm / 0.39" should be maintained from other devices on casing sides without ventilation surfaces.

In order to avoid overheating, do not cover the ventilation areas of the monitor or the device.

A minimum distance of 200 mm / 7.87" from the device must be observed for ventilation areas.

Do not expose the device to extreme ambient conditions (see "[Technical data](#)", Page 58, section "Ambient conditions"). Protect the device against dust, humidity and heat.

When the lighting conditions are unfavourable (for instance direct sunlight), reflections may occur which can cause the displayed characters to be difficult to read. Suitable ambient lighting is necessary to avoid these kinds of reflections.

In addition, align your system according to the ambient lighting conditions, for instance by changing the position of the display (horizontal or vertical angle).

Setting up an ergonomic video workstation

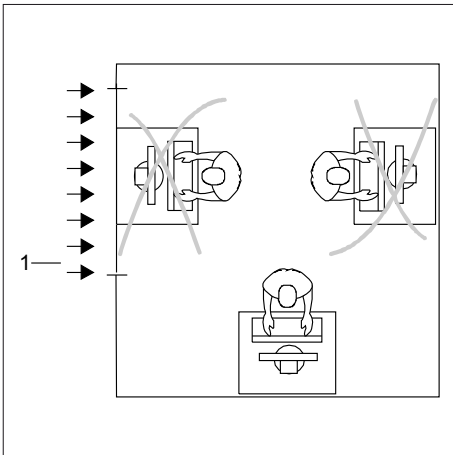

- ▶ Do not position the video workstation opposite a window (1).

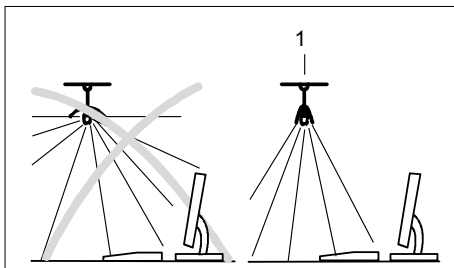

- Position the system outside the reach of a light source (1).



- Position the keyboard where it is easiest to reach (1).

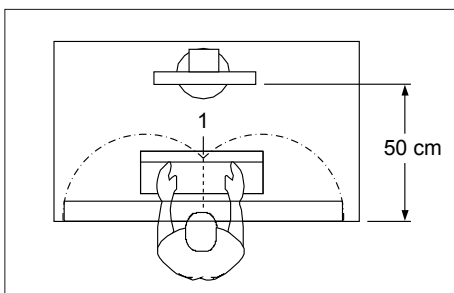

- Position the system so that the eye distance to the screen (1) is around 50 cm / 19.69".

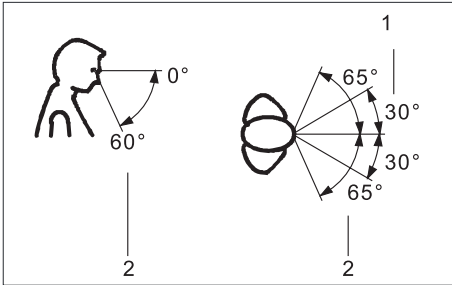

- ▶ Position the device for optimum viewing (1). The monitor should not extend beyond the acceptable viewing range (2).

Setting up the PC



After unpacking the monitor, it will still be in transport position. The monitor is set to the lowest possible position.

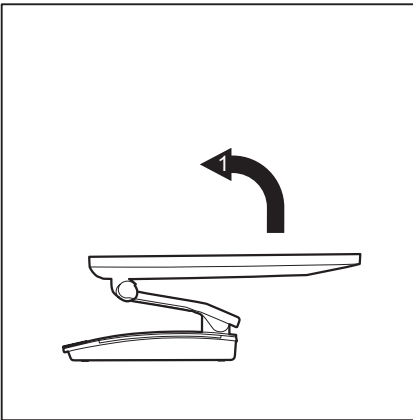

- ▶ Place the monitor on a desk.
- ▶ Hold the monitor with both hands on the left and right edges and pull it into working position in the direction of the arrow (1).

Adjusting height

i

The display is equipped with a synchronized hinge arm. This makes it possible to retain the set monitor tilt for all height settings.

The height of the monitor can be adjusted by approximately 70 mm / 19.69".

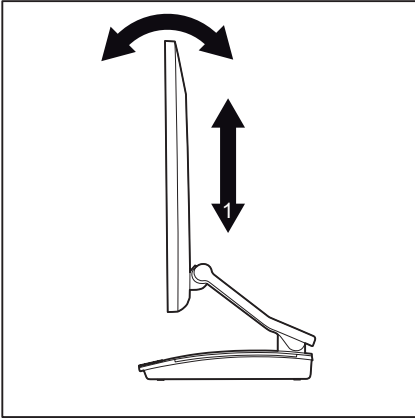

- ▶ Hold the monitor with both hands on the right and left edge of the casing and move it up or down (1).

Adjusting the inclination

The inclination of the monitor can be adjusted by 0° (forwards) and +25° (backwards) from its vertical position.

- ▶ Hold the monitor with both hands on the left and right sides of the casing and move it to the desired angle.

Connecting the power cable



Observe the safety notes in the enclosed "Safety/Regulations" manual.

The supplied power cable conforms to the requirements of the country in which you purchased your device. Make sure that the power cable is approved for use in the country in which you intend to use it.

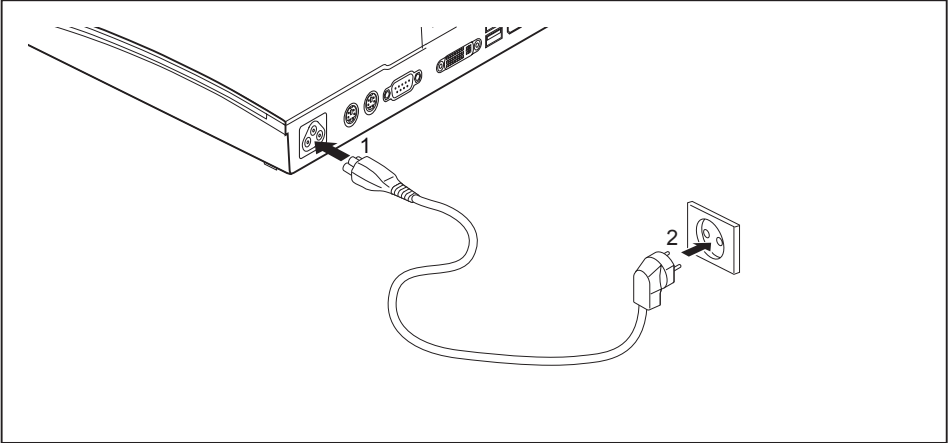

- ▶ Connect the power cable (1) to the power connection (AC IN) of the device.
- ▶ Plug the mains cable (2) into a mains outlet.

Connecting external devices



Read the documentation on the external device before connecting it.

With the exception of USB devices, always remove all power plugs before connecting external devices!

Do not connect or disconnect cables during a thunderstorm.

Always take hold of the actual plug. Never unplug a cable by pulling the cable itself.

Connect and disconnect the cables in the order described below.

Connecting the cables

- ▶ Switch off all affected devices.
- ▶ Remove all power plugs from the grounded mains outlets.
- ▶ Connect all the cables to the device and the external devices. Please make sure that you always observe the safety notes provided in ["Important notes", Page 12](#).
- ▶ Plug all data communication cables into the appropriate sockets.
- ▶ Plug all power cables into the grounded mains outlets.



USB devices are hot-pluggable. This means you can connect and disconnect USB cables while your device is switched on.

Additional information can be found in ["Connecting external devices to the USB ports", Page 27](#) and in the documentation for the USB devices.

Disconnecting the cables

- ▶ Turn off all power and equipment switches.
- ▶ Remove all power plugs from the grounded mains outlets.
- ▶ Unplug all data communication cables from the appropriate sockets.
- ▶ Disconnect all of the cables from the device and from the external devices.

Ports on the device

The ports are located on the front and rear side of the device. The ports available on your device depend on the configuration level you have selected. The standard ports are marked with the symbols shown below (or similar). Detailed information on the location of the ports is provided in the manual for the mainboard.



DVI-I monitor port, white



Audio input (Line in)



Audio output (Line Out), light green



USB 3.0 - Universal Serial Bus, blue (device-dependent)



USB 2.0 - Universal Serial Bus, black



LAN port



Serial port (device-dependent)



Some of the connected devices require special software (e.g. drivers) (refer to the documentation for the connected device and operating system).

Connecting a USB mouse

- ▶ Connect the USB mouse to one of the USB ports on the device.

Connecting a USB keyboard

Only use the keyboard cable supplied with the keyboard (not within the delivery scope of the device).

- ▶ Plug the rectangular connector of the keyboard cable into the rectangular socket on the underside or on the rear of the keyboard.
- ▶ Insert the flat rectangular USB plug of the keyboard cable into a USB port of the device.

Connecting external devices to the USB ports

You can connect a wide range of external devices to the USB ports (e.g. printer, scanner, modem or keyboard).



USB devices are hot-pluggable. This means you can connect and disconnect USB cables while your device is switched on.

Additional information can be found in the documentation for the USB devices.

- ▶ Connect the data cable to the external device.
- ▶ Connect the data cable to one of the USB ports on your device.

Device drivers



The external USB devices that you connect to one of the USB ports usually require no driver of their own, as the required software is already included in the operating system. If the device requires separate software, please note the information in the manufacturer's manual.

To ensure the USB transmission capacity, the cable from the external USB device to the USB port of your device must not be longer than 3 m.

Connecting an external monitor

It is possible to connect a digital monitor to the DVI monitor port. Screen output is limited to a maximum of two monitors at any one time (see ["Important keys and keyboard shortcuts", Page 41](#), section "Toggle screen output").

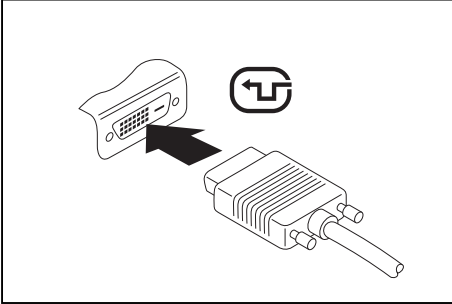

Digital DVI monitor port

- ▶ Switch off the system.
- ▶ Plug the data cable of the external monitor into the monitor port.
- ▶ First switch on the external monitor and then the system.



You can also switch back and forth between the external monitor and the LCD monitor of the system, see chapter ["Important keys and keyboard shortcuts", Page 41](#).

You can display the same picture on the external monitor and the system's LCD monitor simultaneously.

Connecting external audio devices

Microphone port/Line In

The microphone port/Line In allows you to connect an external microphone, a MiniDisc player, MP3 player, CD player or a tape deck to your system.

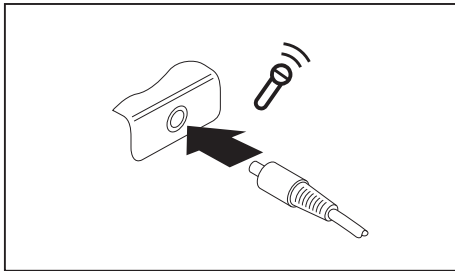

- ▶ Connect the audio cable to the external device.
- ▶ Connect the audio cable to the microphone port/Line In of the system.

Headphone port

You can connect headphones or external loudspeakers to your system via the headphone port.

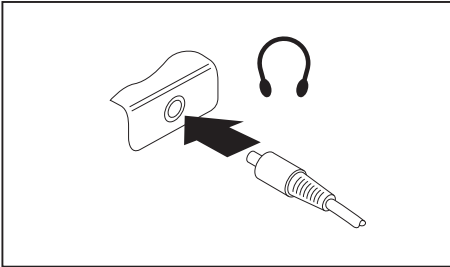

- ▶ Connect the audio cable to the external device.
- ▶ Connect the audio cable to the headphones port of the system.
- ↳ The internal loudspeakers are disabled.



If you purchase a cable from a retailer, please note the following information:

The headphones port on your system is a "3.5 mm jack socket".

If you want to connect headphones or a speaker you will need a "3.5 mm jack plug".

Switching on for the first time: installing the software



Once the installation has been started the device must not be switched off, unless the installation has been completed.

During installation, the device may only be rebooted when you are requested to do so!

The installation will otherwise not be carried out correctly and the contents of the hard disk must be completely restored.



If the device is integrated into a network, the user and server details as well as the network protocol are required during the software installation.

Contact your network administrator if you have any questions about these settings.

When you switch on the device for the first time, the supplied software is installed and configured. Plan a reasonable amount of time for this, as this process must not be interrupted.

You may need the licence number for Windows during the installation. The licence number is located on a sticker on your device.

Switching the device on



In order to avoid overheating, do not cover the ventilation areas on the monitor or the device.

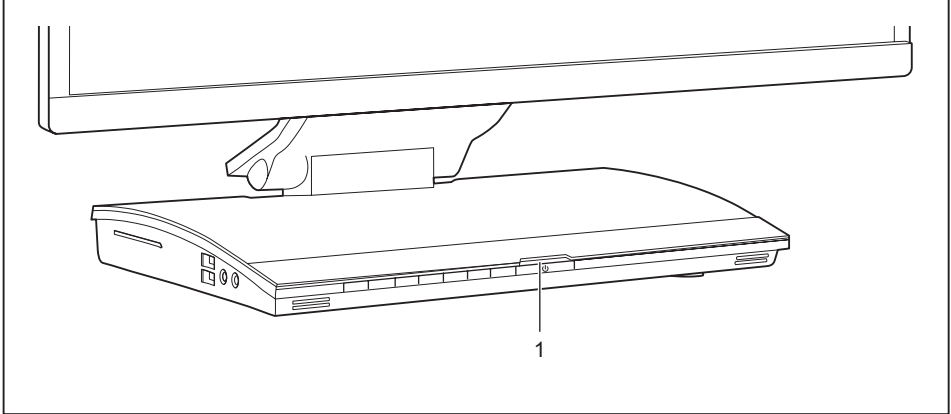

- ▶ Press the ON/OFF switch on the front of the device (1).
- ↳ The operational display will light up and the machine will start.

Installing the software

- ▶ During installation, follow the on-screen instructions.
- ▶ If anything is unclear regarding the data you are asked to input, read the online Help in your operating system.



You will find more information on the system, as well as drivers, utilities and updates on the "Drivers & Utilities" DVD and on the Internet at ["http://www.fujitsu.com/fts/support"](http://www.fujitsu.com/fts/support).

You can find information and help on the Windows operating system functions on the Internet at ["http://windows.microsoft.com"](http://windows.microsoft.com).

Operation

Switch the device on

- ▶ Press the ON/OFF switch on the front of the device.
- ↳ The power indicator glows and the device is started.

Switching off the device

- ▶ Shut down the operating system in a defined manner. In Windows: via the *Start* menu and the *Turn Off Computer* function.
- ▶ If the operating system does not automatically switch the device into energy-saving mode or switch it off, press the ON/OFF switch until the device switches off. Warning, this could lead to a loss of data!
- ↳ If the device is switched off, the device consumes a minimum of energy.



The ON/OFF switch does not disconnect the device from the mains voltage. To completely disconnect the mains voltage, remove the power plug from the power socket.

Activating power-saving mode

Due to customer requirements and requirements of the operating system, the "Wake-on-LAN" (WoL) function is set by default. The WoL function increases the idle current slightly.

In order to meet the requirements of EU Directive "COMMISSION REGULATION (EC) No 1275/2008 of 17 December 2008 implementing Directive 2005/32/EC", the default WoL settings must be changed as follows:

- ▶ To start the *BIOS Setup Utility* after system boot, press function key **F2**.
- ▶ In the *Power* sub-menu, select the *Low Power Soft Off* setting and switch it to *enabled*.
- ▶ To save the setting and exit the *BIOS Setup Utility*, press function key **F4**.
- ↳ After making this change, the system will achieve the lowest energy saving mode during shut-down.

LCD screen

High-quality TFT monitors are installed in systems from Fujitsu Technology Solutions GmbH. For technical reasons, TFT monitors are manufactured for a specific resolution. An optimal, clear picture can only be ensured with the correct resolution intended for the relevant TFT monitor. A screen resolution which differs from the specification can result in an unclear picture.

The screen resolution of the LCD monitor of your system is optimally set at the factory.



TFT monitors are operated with LED background lighting. The luminosity of the background lighting can decrease during the period of use of the system. However, you can set the brightness of your monitor individually.

Changing the monitor settings with the buttons of the control panel



The buttons of the control panel have two functions. When the OSD menu is active, the current meaning of the buttons is shown directly over the buttons on the edge of the screen (softkeys). With the OSD menu not activated, you can make the following settings directly:

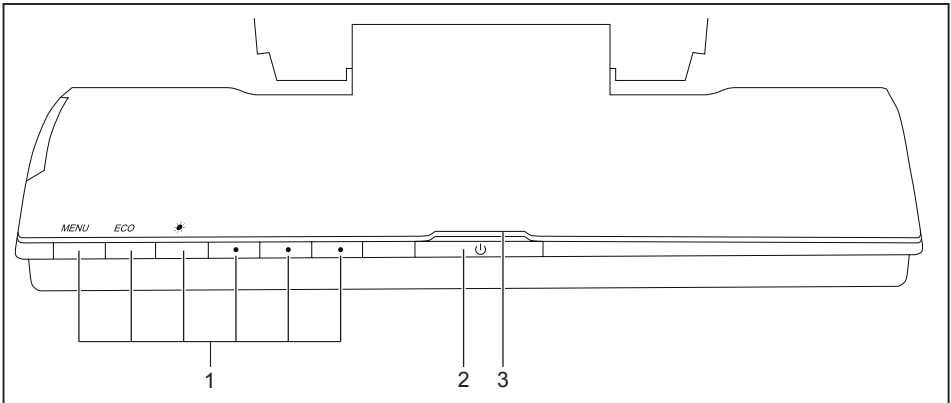

1 = Buttons for the OSD menu (On Screen Display)

3 = Power supply indicator

2 = ON/OFF switch

Select OSD language

After switching on for the first time, the language selection menu of the display is displayed:

- ▶ Press the ● (4th button from left) / △ button or the ● (5th button from left) / ▽ button, to select the desired language.
- ▶ Press the [MENU] / ✓ button to confirm.



After selecting the OSD language for the first time, you can change it at any time in the OSD.

Activating/deactivating ECO operating mode



The power consumption of the device can be decreased by reducing the brightness of the picture.

- ▶ To activate or deactivate ECO operating mode, press the [ECO] button.
- ↳ The message *ECO Mode on* or *ECO Mode off* is displayed.
If you press the [ECO] button, the brightness of the monitor is reduced to an energy saving status.
After ending ECO mode, the previously set brightness is restored.

Locking the OSD menu

The OSD menu can be locked to prevent accidental or unauthorised changes to the monitor settings.

- ▶ Press the [ECO] and ● buttons (5th button from left) simultaneously for a few seconds.
- ↳ The message *OSD locked / unlocked* is displayed.



Please proceed in the same manner to release the locked OSD menu again.

Changing the monitor settings using the OSD menu

With the buttons on the control panel, you can call up and use the integrated OSD (On-Screen Display) menu.



The English menu names are used in the following description (default setting).

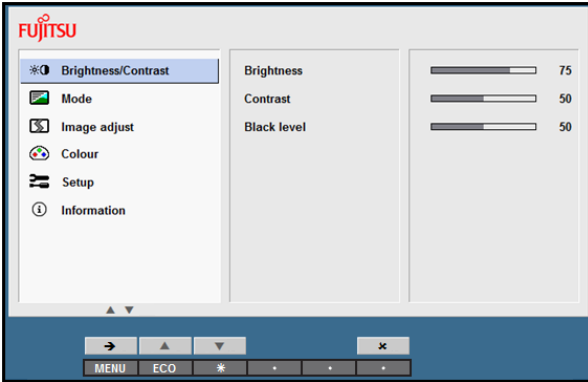

- ▶ Press the **MENU** button to activate the OSD menu.
- ↳ The main menu appears, with icons for the setting functions.
The first symbol, (*Brightness/Contrast*), is highlighted and the associated functions are visible in the right-hand menu field.
- ▶ To highlight another icon (e.g. *Image adjust*), press the **ECO** / \triangle button or the \ast / ∇ button.
- ▶ Press the **MENU** / \rightarrow button to select the highlighted icon.
- ↳ The *Image adjust* settings window is displayed.
- ▶ To exit the main menu, press the \bullet (6th button from left) / \times button.

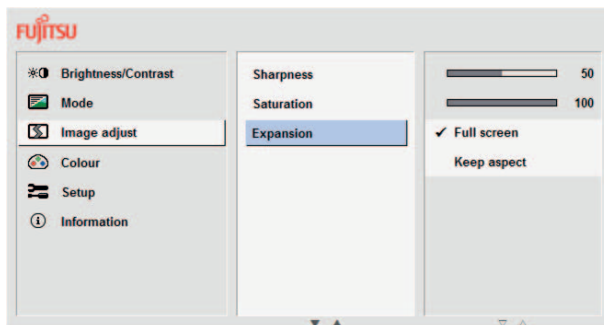

- ▶ To highlight a different function, press the **[ECO]** / Δ button or the \ast / ∇ button.
- ▶ To change the setting, press the \bullet (4th button from left) / + button or the \bullet (5th button from left) / - button.
- ▶ To highlight a different function, press the **[ECO]** / Δ button or the \ast / ∇ button,
- ▶ to save the change, press the **[MENU]** / \checkmark button or the
 - \bullet (6th button from left) / \curvearrowright button to exit the function without change.



If you want to change other settings, select the corresponding function from the OSD main menu. All possible adjustments of the main menu are described in the following.

Adjusting the brightness and contrast

	Call up the <i>Brightness/Contrast</i> setting window
<i>Brightness</i>	Set the brightness of the display With this function you change the brightness of the background lighting.
<i>Contrast</i>	Set the contrast of the display With this function you modify the contrast of bright colour tones.
<i>Black level</i>	Set the brightness of the display With this function you modify the contrast of dark colour tones.



If the contrast is set too high, bright surfaces can no longer be distinguished from very bright surfaces. If the contrast is set too low, the maximum brightness will not be achieved.

Selecting the application mode

	Call up the <i>Mode</i> setting window
<i>sRGB</i>	Predefined settings for sRGB (reduced brightness)
<i>Office</i>	Office presets (the settings for <i>colour</i> and <i>sharpness</i> can be adjusted)
<i>Photo</i>	Predefined settings for photo (<i>colour</i> , <i>sharpness</i> , <i>saturation</i>)
<i>Video</i>	Predefined settings for video (<i>colour</i> , <i>sharpness</i> , <i>saturation</i>)



ACR = Dynamic contrast (on / off)

OD = Overdrive

Adjusting the picture size and position

	Call the <i>Image adjust</i> setting window
<i>Sharpness</i>	Adjust the picture definition for <i>Office</i> , <i>Photo</i> and <i>Video</i> mode.
<i>Saturation</i>	Adjust the colour saturation for <i>Office</i> , <i>Photo</i> and <i>Video</i> mode.
<i>Expansion</i>	Adjust the picture size <i>Full screen</i> = selection of full screen mode <i>Keep aspect</i> = maximum picture size without distortion (only for PC image)

Setting colour temperature and colours

	Call the <i>Colour</i> setting window
	Select the colour temperature The "warmth" of the screen colours is set using the colour temperature. The colour temperature is measured in K (= Kelvin). You can choose between <i>sRGB</i> , <i>6500 K</i> , <i>7500 K</i> , <i>9300 K</i> , <i>Native</i> and <i>Custom Colour</i> . The options <i>sRGB</i> , <i>Native</i> and <i>Custom colour</i> are only available in the <i>Office</i> setting mode. In the user-defined setting you can change the colour ratios of the basic colours (red, green, blue) as required.

Setting functions

	Call up the <i>Setup</i> settings window
<i>Language</i>	Set the language for the OSD menu With this function you select the language for the OSD menu. The default setting is English.
<i>Camera</i> (optional)	Activate/deactivate camera <i>On</i> = Optional camera activated (default setting) <i>Off</i> = Optional camera deactivated
<i>Presence sensor</i> (optional)	Activate/deactivate presence sensor <i>On</i> = Optional presence sensor activated (default setting) <i>Off</i> = Optional presence sensor deactivated
<i>DDC-CI</i>	Activates/deactivates the DDC-CI function <i>On</i> = The DDC-CI function is activated (default setting) <i>Off</i> = The DDC-CI function is deactivated
<i>OSDTimeout</i>	Set the display duration of the OSD menu With this function you select a value from 10 to 120 seconds. If the set time expires without a setting being made, the OSD menu is automatically faded out.
<i>Factory recall</i>	Activate the factory settings With this function all settings are reset to the factory settings without prompting for confirmation. The function is executed with the ● button (5th button from left). The language selection menu appears.



The settings functions for the camera and the presence sensor are only displayed if the optional camera module is installed.

Displaying information

	Call the <i>Information</i> setting window This function displays the resolution, application mode, colour temperature, H/V frequency, ACR status and ECO mode.
--	--

Notes on ergonomic colour adjustment



If you select colours for the monitor in your application programmes, take note of the information below.

The primary colours blue and red on a dark background do not produce the minimum required contrast of 3:1 and are therefore not suitable for continuous text and data entry.

When using several colours for characters and background and giving the primary colours full modulation, you can obtain very suitable colour combinations (see the following table):

Background	Characters							
	black	white	purple	blue	cyan	green	yellow	red
black		+	+	-	+	+	+	-
white	+		+	+	-	-	-	+
purple	+	+		-	-	-	-	-
blue	-	+	-		+	-	+	-
cyan	+	-	-	+		-	-	-
green	+	-	-	+	-		-	-
yellow	+	-	+	+	-	-		+
red	-	+	-	-	-	-	+	

+ Colour combination very suitable

- Colour combination not suitable because colour hues are too close together, thin characters are not identifiable or rigorous focusing is demanded of the human eye.

Preset operating modes



The picture position and size have been set to optimum values at the factory for the operating modes listed above.

For ergonomic reasons, a screen resolution of 1920 x 1080 pixels is recommended. Because of the technology used (active matrix), an LCD monitor provides a totally flicker-free picture, even with a refresh rate of 60 Hz.

Most frequent operating modes

Horizontal frequency	Refresh rate	Screen resolution
31.5 kHz	70 Hz	720 x 400
31.5 kHz	60 Hz	640 x 480
37.5 kHz	75 Hz	640 x 480
37.9 kHz	60 Hz	800 x 600
46,9 kHz	75 Hz	800 x 600
48.4 kHz	60 Hz	1024 x 768
55,4 kHz	60 Hz	1440 x 900
60.0 kHz	75 Hz	1024 x 768
64,0 kHz	60 Hz	1280 x 1024
65.0 kHz	60 Hz	1680 x 1050
67.5 kHz	60 Hz	1920 x 1080
80.0 kHz	75 Hz	1280 x 1024

Indicators on the device

The indicators are on the front of the casing.

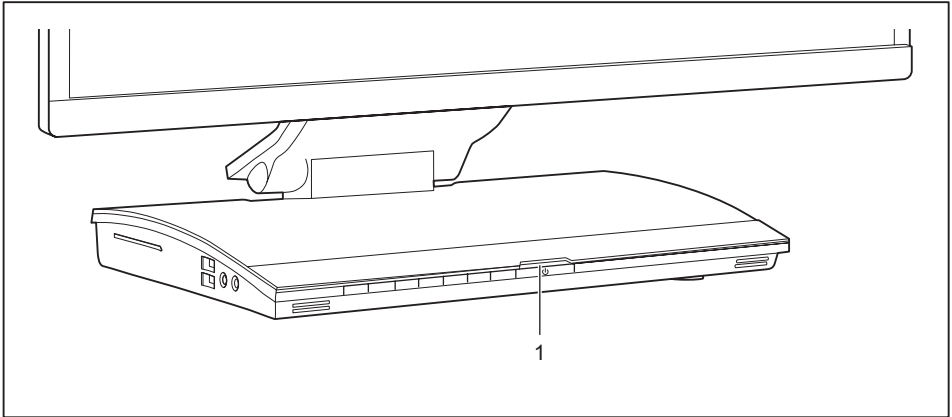

No.	indicator	Description
1	Power-on indicator	<p>Caution:In energy saving mode, the device must not be disconnected from the mains supply as this can cause loss of data.</p> <ul style="list-style-type: none"> • The indicator is illuminated: The device is switched on. • The indicator is flashing: The device is in energy-saving mode. After being switched on with the ON/OFF switch, the device powers up or returns to the state it was in before it entered energy-saving mode. • The indicator is not illuminated: The device is switched off (disconnected from the mains) or is ready to operate. If the device is ready to operate, it can be switched on with the ON/OFF switch.



In energy-saving mode the device must not be disconnected from the mains supply, as data loss may occur.

Keyboard



The illustrated keyboard is an example and may differ from the model you use.

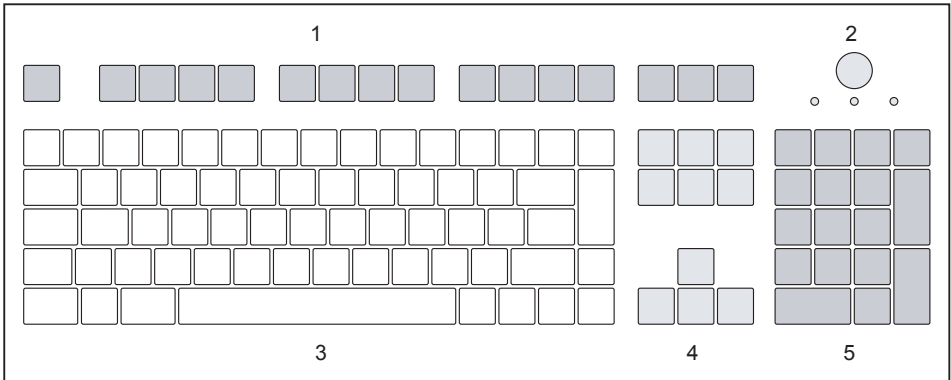

1 = Function keys

4 = Cursor keys



2 = On/off switch (optional)









5 = Numeric keypad (calculator keypad)

3 = Alphanumeric keypad

Important keys and keyboard shortcuts

The description of the following keys and keyboard shortcuts applies to Microsoft operating systems. Details of other keys and keyboard shortcuts can be found in the documentation for the relevant application program.

Key / key combination	Description
	<p>On/off switch (optional)</p> <p>Depending on the setting in the <i>BIOS Setup</i>, the device can be switched on or off with this switch. Some operating systems allow you to configure additional functions of the ON/OFF switch in the Control Panel.</p> <p>With some keyboards the ON/OFF switch can only be used with an ACPI (Advanced Configuration and Power Management Interface). Otherwise the key is inoperative. The mainboard must support this function.</p>
	<p>Enter key</p> <p>confirms the highlighted selection. The Enter key is also referred to as the "Return" key.</p>

Key / key combination	Description
	<p>Windows button</p> <p>The Windows button switches between the start screen and the last used application.</p>
	<p>Menu key</p> <p>The menu button opens the menu for the active application.</p>
	<p>Shift key</p> <p>enables upper-case letters and the upper key symbols to be displayed.</p>
	<p>Alt Gr button (device-dependent)</p> <p>produces a character shown on the bottom right of a key (e.g. the @ sign on the  key).</p>
	<p>Num Lock key</p> <p>By pressing the Num Lock key you switch between the upper- and lower-case levels of the calculator keypad.</p> <p>When the Num Lock indicator is lit the numeric keypad and arithmetic keys are active.</p> <p>When the Num Lock indicator is not lit the cursor control functions on the Numeric keypad are active.</p>
	<p>Ctrl key</p> <p>performs a special operation when pressed in conjunction with another key. The  key is also called the "Control" or "Control key".</p>
	<p>Windows security/Task-Manager</p> <p>This key combination opens the Windows Security/Task Manager window.</p>

Webcam module (optional)



Your system can be equipped with a webcam module as an option.

No forces may be exerted on the webcam module, such as those which occur during adjustment of the monitor or movement of the system.

The webcam module has the following functions:

- Webcam: for video recordings up to a resolution of 720 p
- Digital mono-microphone: for audio recordings
- Ultrasonic presence sensor

Your webcam module

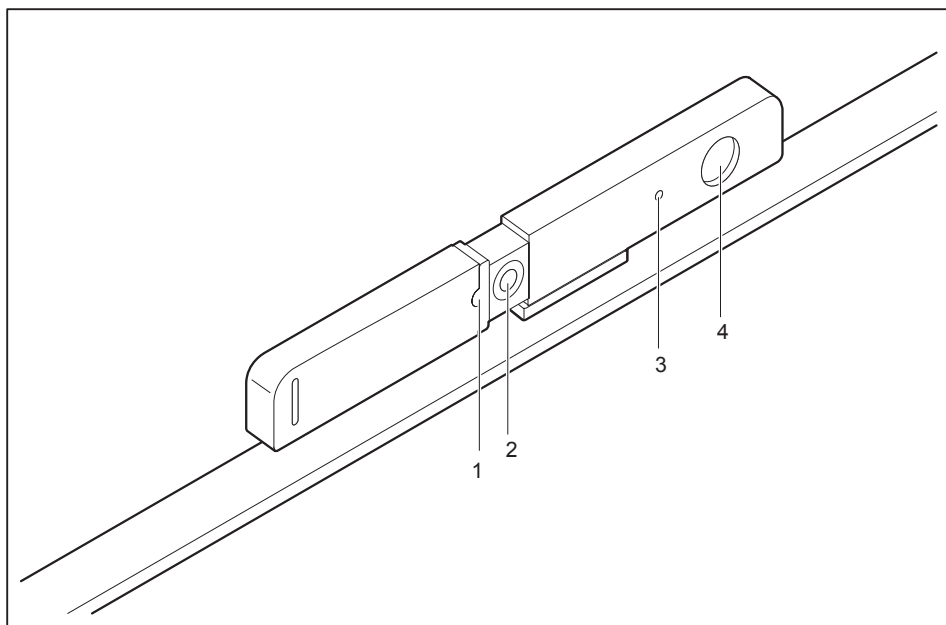

1 = LED indicators
2 = Lens

3 = Mono-microphone
4 = Ultrasonic presence sensor

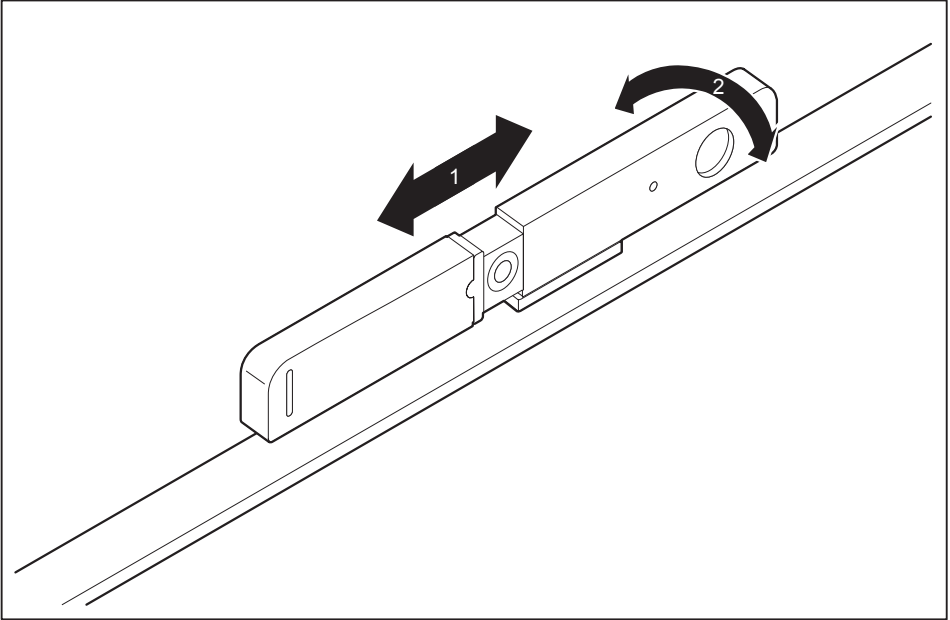

The webcam module can be activated and deactivated via the sliding mechanism (1) or adjusted upwards or downwards by tilting the viewing angle (2).



The webcam can be deregistered from the system either mechanically via the sliding mechanism or via the OSD menu.

The presence sensor can be deactivated via the OSD menu.

The digital microphone can only be deactivated via the operating system.

The sliding mechanism only influences the webcam function.

Depending on the software used, you can use this webcam module to take pictures, record video clips or take part in web chats.

The webcam module has a separate LED indicator. The LED indicator lights up when the webcam is switched on.

- The picture quality depends on the lighting conditions and the software being used.
- You can only operate the webcam module with a particular application (e.g. an Internet telephony program or a video conferencing program which supports a webcam).
- When using the webcam module, the system support (e.g. the table) should not wobble or vibrate, as this affects the picture quality.
- The webcam module automatically adjusts itself to the current light level. For this reason the LCD display may flicker while the light level is adjusted.



Further information on use of the webcam module and additional settings for your webcam module can be found in the help function of the program using the webcam.

Presence sensor

The presence sensor from Fujitsu ensures high operating comfort, good workplace security and other energy saving options. This is enabled by individual and automatic system functions.

The sensor automatically detects the presence or absence of a person. The respective detection status can be assigned various system settings.

Upon detection of the absence of a person:

- Dim or deactivate monitor
- Activate screen saver
- Secure access to the system
- Switch system to Hibernate or Standby mode

Upon detection of the presence of a person:

- Activate the monitor
- Wake up the system



The presence sensor may have to be readjusted after adjustment of the height or tilt of the monitor, in order to guarantee proper functioning.

Wireless LAN/Bluetooth radio components (optional)



The installation of radio components not approved by Fujitsu will invalidate the certifications issued for this device.



Operation of the module is not permitted in Taiwan.



The FUTRO system only has the wireless LAN radio components.

Switching the wireless components on and off



You can use the *Device Manager* program to switch the radio components on and off individually.

Pay attention to the additional safety notes for devices with radio components provided in the "Safety/Regulations" manual.

Details on using Wireless LAN can be found in the online help system included with the Wireless LAN software.

You can find more information on how to use Bluetooth on the CD you received with your Bluetooth software.

Power over Ethernet module for FUTRO X913/X913-T (optional)



Your FUTRO can be equipped with an optional Power over Ethernet module.

Using the Power over Ethernet adapter, you can operate the FUTRO via the LAN without an additional power connection. To do this, you will need a corresponding network infrastructure.

To operate the FUTRO via the Power over Ethernet adapter, midspan devices (power supply via intermediary sources, such as PoE injector) with a power output of 60 W and shielded CAT-5 network cable or higher quality cable are required. Endspan devices (direct power supply via a PoE switch) are only supported in connection with a hardware classification.

Fujitsu recommends the use of the following midspan devices:

- 1-port midspan from Microsemi PD-9501G: S26361-F1744-L10
- 12-port midspan from Microsemi PD-9512G: S26361-F1744-L20



When operating the FUTRO via the Power over Ethernet adapter, the external USB power output is limited to max. 5 watts.

Settings in BIOS Setup Utility

The *BIOS Setup Utility* allows you to set the system functions and the hardware configuration for your device.

When it is supplied, the device is set to factory default settings. You can change these settings in the *BIOS Setup Utility* menu. Any changes you make take effect as soon as you save and exit the *BIOS Setup Utility*.

The *BIOS Setup Utility* program contains the following menus:

Menu	Description
<i>Main</i>	System settings such as time and date
<i>Advanced</i>	Advanced system settings
<i>Security</i>	Password settings and security functions
<i>Power</i>	Energy saving function
<i>Event Logs</i>	Protocol settings
<i>Boot</i>	Configuration of the start-up sequence
<i>Save & Exit</i>	Exits the <i>BIOS Setup Utility</i>

The following function keys can also be used:

Key	Description
Esc	To exit the <i>BIOS Setup Utility</i> . The current settings are not saved.
F2	To reject changes and load the previous configuration of the <i>BIOS Setup Utility</i> .
F3	To load the default configuration of the <i>BIOS Setup Utility</i> .
F4	To exit the <i>BIOS Setup Utility</i> . The current settings are saved.

Starting the BIOS Setup Utility

- ▶ Reboot the device (switch off/on or reboot the operating system).
- ↳ The following or a similar display appears on the screen at start-up:
<F2> BIOS Setup <F12> Boot Menu

- ▶ Press the function key **F2**.
- ▶ If a password has been assigned, enter the password and press the Enter key.



If you have forgotten the password, contact your system administrator or contact our customer service centre.

The *BIOS Setup Utility* starts.

Operating BIOS Setup Utility



Press the **F1** key to display help on the operation of the *BIOS Setup Utility*. The description of the individual settings is shown in the right-hand window of the *BIOS Setup Utility*.

With the **F3** key you can load the default settings of the *BIOS Setup Utility*.

- ▶ Use the cursor keys **←** or **→** to select the menu you wish to access to make changes.
 - ↳ The menu is displayed on the screen.
- ▶ Select the option you want to change with the cursor keys **↑** or **↓**.
- ▶ Press the Enter key.
- ▶ Press the **ESC** key to exit the selected menu.
- ▶ For future reference, make a note of the changes you have made (for example, in this manual).

Exiting BIOS Setup Utility

You need to select the desired option in the *Save & Exit* menu and activate it by pressing the Enter key:

Save Changes and Exit - Save the changes and exit the BIOS Setup Utility

- ▶ To save the current menu settings and exit the *BIOS Setup Utility*, select *Save Changes and Exit* and *Yes*.
 - ↳ The device is rebooted and the new settings come into effect.

Discard Changes and Exit - Discard changes and exit the BIOS Setup Utility

- ▶ Select *Discard Changes and Exit* and *Yes* to discard the changes you have made.
 - ↳ The settings which applied when *BIOS Setup Utility* was called up remain effective. The *BIOS Setup Utility* is terminated and the device is rebooted.

Property and data protection

Software functions and mechanical locking offer a broad range of functions for protecting your device and your personal data from unauthorised access. You can also combine these functions.

Using the Security Lock

Your device has a Security Lock device. Using the Security Lock device and the Kensington Lock cable (steel cable, accessory) you can protect your device against theft. Consult the manual for your Kensington Lock Microsaver.



The Security Lock can also be used to protect the recovery button behind it against unauthorized actuation. The recovery button is on the right-hand side of the system behind the Security Lock device (2).

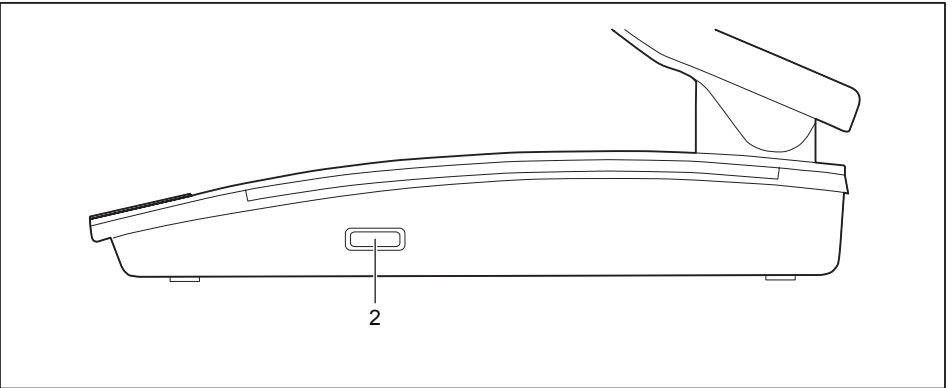
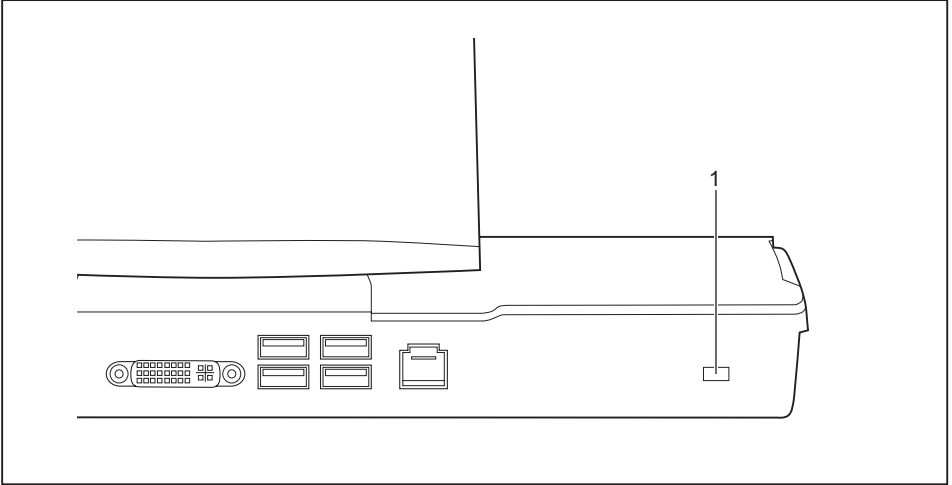

- ▶ Attach the Kensington Lock cable to the Security Lock device (1) or (2) on your device.

BIOS Setup security functions

The *Security* menu in the *BIOS Setup* offers you various options for protecting your personal data against unauthorized access, e.g.:

- Prevent unauthorised access to the system
- Prevent unauthorized access to the *BIOS Setup*



Before using the various options for password protection in the *BIOS Setup utility* to increase data security, please observe the following:

Make a note of passwords and keep them in a safe place. If you forget your supervisor password you will no longer be able to access your device. Deleting passwords is not covered by your warranty and a charge will be made for assistance.



Your password can be a maximum of 32 characters long and can consist of letters and numbers. No distinction is made between uppercase and lowercase.

SmartCard reader (optional)

SmartCards are not supplied as standard equipment. You can use all SmartCards that comply with the ISO standard 7816-1, -2 or -3. These SmartCards are available from various manufacturers.

With the appropriate software you can use your SmartCard as an alternative to password protection, but also as a digital signature, for encrypting your e-mails or for home banking.

We recommend that you always use two SmartCards. Always keep one of the SmartCards in a safe place if you are carrying the other SmartCard with you.

In order to be able to take advantage of all the security features of your system, you will need a CardOS SmartCard from Fujitsu Technology Solutions.



The SmartCard can only be used with a PIN, offering maximum protection even if you lose the SmartCard. In order to maximise your security, the CardOS SmartCard is disabled if three incorrect attempts are made to enter the PIN.

When you use the CardOS SmartCard for the first time, you will either need to enter the preset PIN "12345678" or the PIN given to you by your systems administrator.

Inserting the SmartCard



Do not use force when inserting and removing the SmartCard.

Make sure that foreign objects do not fall into the SmartCard reader.

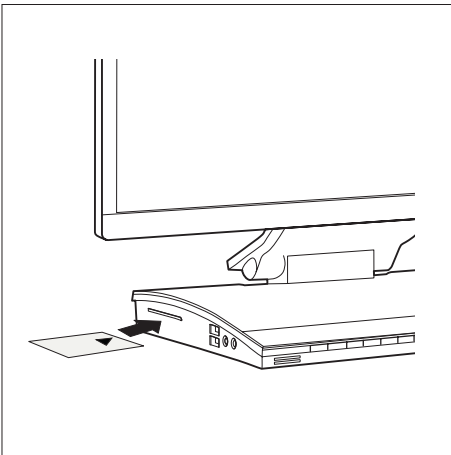

- ▶ Slide the SmartCard into the SmartCard reader with the chip facing upwards (on some variants it faces down) and to the front.

Troubleshooting and tips



Refer to the safety notes in the "Safety/regulations" manual and in the ["Getting started", Page 19](#) chapter when connecting or disconnecting cables.

If a fault occurs, try to correct it as described in the following documentation:

- in this chapter
- in the documentation for the connected devices
- in the help systems of the software used
- in the documentation for your operating system

Help if problems occur

Should you encounter a problem with your computer that you cannot resolve yourself:

- ▶ Note the ID number of your device. The ID number can be found on the type rating plate on the underside of the device.
- ▶ For further clarification of the problem, contact the Service Desk for your country (see the Service Desk list or visit the Internet at "<http://support.ts.fujitsu.com/contact/service desk>"). When you do this, please have ready the ID number and serial number of your system.

Troubleshooting

Power-on indicator remains unlit after you have switched on your device

Cause	Troubleshooting
The mains voltage supply is faulty.	<ul style="list-style-type: none">▶ Check that the power cable is properly plugged into the device and into the mains socket.
Internal power supply overloaded.	<ul style="list-style-type: none">▶ Unplug the power plug of the device from the mains socket.▶ Wait approx. 3 min.▶ Plug the power plug of the device into the mains socket again.▶ Switch the device on.

The device cannot be switched off with the ON/OFF switch.

Cause	Remedy
System crash	<ul style="list-style-type: none"> ▶ Keep the on/off switch pressed for at least 4 seconds until the machine switches off. <p>Caution: This can lead to a loss of data!</p> <p>This procedure does not allow the operating system to shut down in an orderly way. The next time the system is started there may well be error messages.</p>

Monitor remains blank

Cause	Remedy
Power saving has been activated (screen is blank)	<ul style="list-style-type: none"> ▶ Press any key on the keyboard. <p>or</p> <ul style="list-style-type: none"> ▶ Deactivate the screen saver. If necessary, enter the appropriate password. <p>or</p> <ul style="list-style-type: none"> ▶ Alter the brightness and/or contrast until you get a picture.
Brightness control is set to dark	<ul style="list-style-type: none"> ▶ Adjust the brightness control.
Wrong setting for the monitor	<ul style="list-style-type: none"> ▶ Restart the device. ▶ Press [F8] while the system is booting. ▶ Start the system in protected mode. ▶ Set the correct value for the connected monitor, as described in the operating instructions for the monitor.
The screen display becomes darker	<p>The background lighting has a limited lifetime.</p> <ul style="list-style-type: none"> ▶ If your screen display becomes too dark, contact our Service Desk. <p>With the passively cooled system variant (FUTRO X913/X913-T), the background lighting can decrease if the system environment does not guarantee adequate dissipation of heat.</p> <ul style="list-style-type: none"> ▶ Check the ambient temperature.
<p>Message:</p> <p>Frequency out of range: ## kHz / ## Hz</p> <p>Please change the display mode to 1920 x 1080 with 60 Hz</p>	<p>The input signal (horizontal frequency and refresh rate) does not correspond to the technical monitor data.</p> <ul style="list-style-type: none"> ▶ Adjust the video frequency range using the computer software (see documentation for your computer or your display adapter) ▶ Adjust a different screen resolution using the computer software (see documentation for your computer or your display adapter).

The external monitor remains blank

Cause	Troubleshooting
Monitor is switched off.	▶ Switch the external monitor on.
Power saving has been activated (monitor is blank).	▶ Press any key to continue.
Brightness is set to dark.	▶ Adjust the brightness of the monitor.
Screen output is set to the system's LCD monitor.	▶ Press the key combination to switch the screen output, see "Important keys and keyboard shortcuts", Page 41 .
The external monitor's power cable or data cable is not connected properly.	<ul style="list-style-type: none"> ▶ Switch off the external monitor and the system. ▶ Check whether the power cable is plugged properly into the external monitor and into the power socket. ▶ Check whether the data cable is properly connected to the system and the external monitor (if it is plugged in with a connector). ▶ Switch on the external monitor and the system.

The external monitor is blank or the image is unstable

Cause	Troubleshooting
The wrong external monitor has been selected or the wrong screen resolution has been set for the application program.	<ul style="list-style-type: none"> ▶ Terminate the application program in Windows by pressing [Alt] + [F4]. If the error persists after terminating the program, use the key combination for switching the screen output (see "Important keys and keyboard shortcuts", Page 41), in order to switch to the LCD monitor of the system. Change the following setting: ▶ Set the screen resolution: Set the screen resolution as described in the documentation for your operating system.

No mouse pointer displayed on the screen

Cause	Remedy
The mouse is not correctly connected.	<ul style="list-style-type: none"> ▶ Shut down your operating system in the proper manner, for instance using [Ctrl] + [Alt] + [Del]. ▶ Switch the device off. ▶ Check that the mouse cable is properly connected to the system unit. If you use an adapter or extension lead with the mouse cable, check the connections. ▶ Make sure that only one mouse is connected. ▶ Switch the device on.

Time and/or date is not correct

Cause	Remedy
Time and date are incorrect.	<ul style="list-style-type: none"> ▶ Set the correct time and date within the operating system you are using. <p>or</p> <ul style="list-style-type: none"> ▶ Set the correct time and/or date in the <i>BIOS Setup</i>.

SmartCard reader is not recognised.

Cause	Troubleshooting
Chip card inserted incorrectly.	<ul style="list-style-type: none"> ▶ Make sure you have inserted your SmartCard into the SmartCard reader with the chip facing upwards. ▶ Check whether the SmartCard you are using is supported. Your SmartCard must comply with the ISO standard 7816-1, -2, -3 and -4.

SmartCard PIN forgotten

Cause	Troubleshooting
PIN forgotten	<ul style="list-style-type: none"> ▶ If you are working in a network, contact your system administrator, who can unlock your system with a Supervisor PIN.

SmartCard lost

Cause	Troubleshooting
SmartCard lost	<ul style="list-style-type: none"> ▶ If you are working in a network, contact your system administrator, who can boot your system with a Supervisor SmartCard.

User and/or supervisor SmartCard lost

Cause	Troubleshooting
User and/or supervisor SmartCard lost	<ul style="list-style-type: none"> ▶ If you have lost your User SmartCard, you can continue working with the Supervisor SmartCard and initialise a new User SmartCard or deactivate the SystemLock function. ▶ If you have lost the Supervisor SmartCard, you can continue working, but you no longer have all your rights and can no longer initialise a Supervisor SmartCard. ▶ If you have lost both SmartCards, you can no longer boot your system. Please contact our Service Desk. You must provide proof of ownership for the device. Then the Service Desk will refer you to our service partner, who will unlock your device (for a charge).

Error messages on the screen

Error messages and their explanations are provided:

- in the technical manual for the mainboard
- in the documentation for the programs used

Installing new software

When installing programs or drivers, important files may be overwritten and modified. To be able to access the original data in the event of any problems following installation, you should backup your hard disk prior to installation.

Restoring the hard disk contents

You will find the instructions for restoring the contents of the hard disk in the "Recovery Guide" manual.

Tips

Topic	Tip
Out of system resources	<ul style="list-style-type: none"> ▶ Close unnecessary applications. <p>or</p> <ul style="list-style-type: none"> ▶ Run the applications in a different order.
Other manuals	Further manuals are provided as PDF files on the "Drivers & Utilities" DVD.

Technical data

Electrical data		
Safety standards complied with:		IEC 60950-1, EN 60950-1, UL 60950-1 CSA 22.2 No.60950-1
Protection class:		II
Rated voltage range		100–240 V
Rated frequency		50–60 Hz (AC)
Max. rated current		1.2–0.6 A
Dimensions		
Width x Depth x Height:	with non-touch monitor	533 mm x 224 mm x 419 mm / 20.98" x 8.82" x 16.50"
	with touch monitor	554 mm x 225 mm x 433 mm / 21.18" x 8.86" x 17.05"
	with touch monitor and camera	554 mm x 225 mm x 456 mm / 21.18" x 8.86" x 17.95"
Weight		
in basic configuration:		approx. 1.8 kg / 3.97 lbs
with standard monitor		6.0 kg / 13.22 lbs
with touch monitor		8.9 kg / 19.62 lbs
Ambient conditions		
Environment class 3K2		DIN EN 60721-3-3
Environment class 2K2		DIN EN 60721-3-2
Temperature		
Operation (3K2)		15 °C 35 °C / 59 °F ... 95 °F
Transportation (2K2)		–25 °C 60 °C / –13 °F ... 140 °F
The formation of condensation is not permitted while the device is in operation !		
Clearance required to ensure adequate ventilation:		
without air vents		min. 10 mm / 0.39"
with air vents		min. 200 mm / 7.87"
Maximum resolution		1920 x 1080
Pixel error class according to ISO 9241-307		Class I



The data sheets of these devices contain further technical data. You can find the data sheets on the Internet at ["http://www.fujitsu.com/fts"](http://www.fujitsu.com/fts).

Index

A

- Alphanumeric keypad 41
- Anti-theft protection 50
- Audio devices, connecting 28
- Audio input 26
- Audio output 26
- Audio ports 28–29

B

- BIOS Setup Utility
 - calling 48
 - exiting 49
 - operating 49
 - settings 48
- Button,
 - ON/OFF switch 41
- Buttons
 - Windows button 42

C

- Cable,
 - connecting 25
 - disconnecting 25
- CE marking 16
- Configuration, BIOS Setup Utility 48
- Connecting
 - USB keyboard 27
- Connecting a USB mouse 27
- Connecting audio devices 29
- Connecting headphones 29
- Contents of delivery 19
- Cord
 - see Cable 25
- Ctrl+Alt+Del 42
- Cursor keys 41

D

- Data protection 49
- Device
 - Ports 26
 - setting up 20
- Device,
 - switching off 31
 - transporting 14
- Devices,
 - connecting 27

- Disposal 14
- Drivers & Utilities DVD 14

E

- Electromagnetic compatibility 16
- Energy saving 14
- Ergonomic
 - Workstation 20
- Ethernet module 47
- ExpressCard slot 8
- External devices
 - Ports 26
- External devices,
 - connecting 27

F

- Function keys 41

G

- Getting started 19

H

- Hardware configuration 48
- Headphones port 8

I

- Important notes 12
- Installing,
 - software 29–30
 - switching on for the first time 29

K

- Keyboard 41
- keyboard shortcuts 41
- Keyboard shortcuts 42
- Keyboard,
 - alphanumeric keypad 41
 - cursor keys 41
 - function keys 41
 - numeric keypad 41
- Keys 41
 - Ctrl 42
 - Ctrl+Alt+Del 42

Keys,

- Alt Gr 42
- Control 42
- Ctrl key 42
- cursor keys 41
- Enter 41
- Enter key 41
- menu key 42
- Num Lock 42
- Return 41
- shift 42
- shift key 42

L

- LAN port 26
- LCD screen
 - notes 32
- Line out 26
- Low voltage directive 16

M

- Mechanical backup 50
- Microphone port 8
- Microphone, connecting 28
- Monitor
 - connecting 28
 - drifting display 54
 - remains blank 54
- Monitor port 26, 28
- Monitor,
 - switching off 31

N

- Note
 - safety 12
- Notes
 - CE marking 16
 - important 12
 - LCD screen 32
- Numeric keypad 41

O

- ON/OFF switch 41
- Overview
 - Device 5

P

- Packaging 19
- Packaging,
 - unpacking 19
- Password protection 50

- Ports 7, 26
- Power cable
 - connection 24
- Preparing for first use, overview 19
- Preparing for operation 24
- Preparing for use,
 - overview 19
- Presence sensor 45
- Property protection 49

R

- Recycling 14
- Retransportation 14

S

- Safety information 12
- Screen
 - no screen display 54
- Security functions
 - SystemLock 51
- Security functions,
 - SmartCard 51
- Security Lock 50
- Security Lock device 9
- Security measures 49
- Serial port 26
- Setup
 - see BIOS Setup Utility 48
- Software,
 - installing 29–30
- System configuration 48
- System settings, BIOS Setup Utility 48
- System unit, see Device 14

T

- Transportation 14

U

- Universal Serial Bus 26
- USB devices,
 - connecting 27
- USB port 8, 27
 - connecting keyboard 27
- USB port,
 - connecting devices 27
- User Documentation DVD 14
- Using the Kensington Lock Cable 50

W

- Webcam module 43
- Workstation 20

