

Dell Precision 7720

Owner's Manual



Notes, cautions, and warnings

 **NOTE:** A NOTE indicates important information that helps you make better use of your product.

 **CAUTION:** A CAUTION indicates either potential damage to hardware or loss of data and tells you how to avoid the problem.

 **WARNING:** A WARNING indicates a potential for property damage, personal injury, or death.

© 2020 Dell Inc. or its subsidiaries. All rights reserved. Dell, EMC, and other trademarks are trademarks of Dell Inc. or its subsidiaries. Other trademarks may be trademarks of their respective owners.

1 Working on your computer	8
Safety instructions.....	8
Turning Off Your Computer.....	8
Turning off your — Windows.....	9
Before working inside your computer.....	9
After working inside your computer.....	9
2 Disassembly and reassembly	11
SD card.....	11
Removing SD card.....	11
Installing SD card.....	11
Battery cover.....	11
Removing the battery cover.....	11
Installing the battery cover.....	12
Battery.....	12
Lithium-ion battery precautions.....	12
Removing the battery.....	12
Installing the battery.....	13
Hard drive.....	13
Removing the hard drive.....	13
Installing the hard drive.....	14
Hard drive cable connector.....	15
Removing the hard drive cable connector.....	15
Installing the hard drive cable connector.....	15
Keyboard lattice and Keyboard.....	16
Removing the keyboard.....	16
Installing the keyboard.....	17
Memory modules.....	17
Removing the primary memory module.....	17
Installing the primary memory module.....	18
Removing the secondary memory module.....	18
Installing the secondary memory module.....	19
Base cover.....	19
Removing the base cover.....	19
Installing the base cover.....	20
WWAN card.....	20
Removing Wireless Wide Area Network - WWAN card.....	20
Installing the WWAN card	21
WLAN card.....	21
Removing the Wireless Local Area Network - WLAN card.....	21
Installing the WLAN Card.....	22
Solid State Drive	22
Removing the M.2 Solid State Drive -SSD module.....	22
Installing the M.2 SSD module.....	23

Coin-cell battery.....	23
Removing the coin cell battery.....	23
Installing the coin cell battery.....	24
Power connector port.....	24
Removing the power connector port.....	24
Installing the power connector port.....	25
Palm rest.....	25
Removing the palmrest.....	25
Installing the palmrest.....	26
Fingerprint reader.....	27
Removing the fingerprint reader.....	27
Installing the fingerprint reader.....	28
Power switch board.....	28
Removing the power switch board.....	28
Installing the power switch board.....	29
ExpressCard Reader.....	30
Removing the expresscard.....	30
Installing the expresscard.....	30
USB board.....	31
Removing the USB board.....	31
Installing the USB board.....	31
Input-Output board.....	32
Removing the left Input-Output -IO board	32
Installing the left IO board	32
Removing the right Input-Output - IO board	33
Installing the right IO board	33
Heat sink	34
Removing the heat sink assembly.....	34
Installing the heat sink assembly.....	34
Graphics card.....	35
Removing the graphic card.....	35
Installing the graphic card.....	35
System board.....	36
Removing the system board.....	36
Installing the system board.....	37
LED board.....	38
Removing the LED board.....	38
Installing the LED board.....	39
Speaker.....	39
Removing the speakers	39
Installing the speakers.....	40
Display assembly.....	40
Removing the display assembly.....	40
Installing the display assembly.....	42
Display bezel.....	42
Removing the display bezel.....	42
Installing the display bezel.....	43
Display panel.....	43
Removing the display panel.....	43
Installing the display panel.....	45

Removing the display panel.....	45
Installing the display panel.....	47
Display bracket.....	48
Removing the display bracket.....	48
Installing the display bracket.....	48
Display hinges.....	49
Removing the display hinge.....	49
Installing the display hinge.....	49
Display cover.....	50
Replacing the display cover.....	50
eDP cable.....	51
Removing the eDP cable.....	51
Installing the eDP cable.....	52
Camera.....	52
Removing the camera.....	52
Installing the camera.....	53
3 Technology and components.....	54
Power adapter.....	54
Processors.....	54
Kaby Lake — 7th Generation Intel Core processors.....	54
USB features.....	55
HDMI 1.4.....	56
4 System specifications.....	58
System information.....	58
Processor.....	58
Memory.....	59
Graphics.....	59
Audio.....	59
Communication.....	59
Expansion bus.....	60
Ports and connectors.....	60
Display.....	60
Keyboard.....	61
Touchpad.....	61
Camera.....	62
Storage.....	62
Battery.....	62
AC adppter.....	63
Contactless smart card.....	63
Physical dimension.....	63
Environmental.....	64
5 System setup.....	65
Boot menu.....	65
Navigation keys.....	65
System setup options.....	66
General screen options.....	66

System Configuration screen options.....	66
Video screen options.....	69
Security screen options.....	69
Secure Boot screen options.....	70
Intel Software Guard Extensions screen options.....	71
Performance screen options.....	71
Power Management screen options.....	71
POST Behavior screen options.....	73
Manageability screen options.....	73
Virtualization support screen options.....	74
Wireless screen options.....	74
Maintenance screen options.....	74
System Log screen options.....	75
Updating the BIOS in Windows	75
System and setup password.....	75
Assigning a system setup password.....	76
Deleting or changing an existing system setup password.....	76

6 Software..... 77

Operating systems.....	77
Downloading drivers.....	77
Downloading the chipset driver.....	77
Chipset drivers.....	78
Intel chipset drivers.....	78
Intel management engine interface -MEI drivers.....	78
Intel dynamic platform and thermal framework drivers.....	79
Intel rapid storage technology- RST drivers.....	79
RealTek PCI-E card reader drivers.....	79
Video Drivers.....	80
UMA graphics drivers.....	80
Discrete graphics drivers.....	80
Audio Drivers.....	80
Realtek audio driver.....	80
Network Drivers.....	80
Intel ethernet controller drivers.....	80
Wireless and bluetooth drivers.....	81
4G LTE mobile broadband drivers.....	81
Input Drivers.....	81
Touchpad driver.....	81
Intel thunderbolt controller driver.....	82
Other drivers.....	82
Intel HID event filter.....	82

7 Troubleshooting..... 83

Enhanced Pre-Boot System Assessment — ePSA diagnostics.....	83
Running the ePSA Diagnostics.....	83
Diagnostic LED.....	83
Battery status lights.....	84
Real Time Clock reset.....	84

Testing memory using ePSA.....	85
8 Contacting Dell.....	86

Working on your computer

Safety instructions

Use the following safety guidelines to protect your computer from potential damage and to ensure your personal safety. Unless otherwise noted, each procedure included in this document assumes that the following conditions exist:

- You have read the safety information that shipped with your computer.
- A component can be replaced or, if purchased separately, installed by performing the removal procedure in the reverse order.

 **NOTE:** Disconnect all power sources before opening the computer cover or panels. After you finish working inside the computer, replace all covers, panels, and screws before connecting to the power source.

 **NOTE:** Before working inside your computer, read the safety information that shipped with your computer. For additional safety best practices information, see the Regulatory Compliance Homepage at www.dell.com/regulatory_compliance

 **CAUTION:** Many repairs may only be done by a certified service technician. You should only perform troubleshooting and simple repairs as authorized in your product documentation, or as directed by the online or telephone service and support team. Damage due to servicing that is not authorized by Dell is not covered by your warranty. Read and follow the safety instructions that came with the product.

 **CAUTION:** To avoid electrostatic discharge, ground yourself by using a wrist grounding strap or by periodically touching an unpainted metal surface that is grounded to ground yourself before you touch the computer to perform any disassembly tasks.



 **CAUTION:** Handle components and cards with care. Do not touch the components or contacts on a card. Hold a card by its edges or by its metal mounting bracket. Hold a component such as a processor by its edges, not by its pins.

 **CAUTION:** When you disconnect a cable, pull on its connector or on its pull-tab, not on the cable itself. Some cables have connectors with locking tabs; if you are disconnecting this type of cable, press in on the locking tabs before you disconnect the cable. As you pull connectors apart, keep them evenly aligned to avoid bending any connector pins. Also, before you connect a cable, ensure that both connectors are correctly oriented and aligned.

 **NOTE:** The color of your computer and certain components may appear differently than shown in this document.

Turning Off Your Computer

 **CAUTION:** To avoid losing data, save and close all open files and exit all open programs before you turn off your computer.

1. Shut down the operating system:
 - In Windows 8:
 - a. Using a touch-enabled device:
 - a. Swipe in from the right edge of the screen, opening the Charms menu and select **Settings**.
 - b. Select the  and then select **Shut down**
 - Using a mouse:
 - a. Point to upper-right corner of the screen and click **Settings**.
 - b. Click the  and select **Shut down**.
 - In Windows 7:

- a. Click **Start** .
- b. Click **Shut Down**.

or



- a. Click **Start** .
- b. Click the arrow in the lower-right corner of the **Start** menu as shown below, and then click **Shut Down**.



2. Ensure that the computer and all attached devices are turned off. If your computer and attached devices did not automatically turn off when you shut down your operating system, press and hold the power button for about 4 seconds to turn them off.

Turning off your — Windows

 **CAUTION:** To avoid losing data, save and close all open files and exit all open programs before you turn off your computer .

1. Click or tap .
2. Click or tap  and then click or tap **Shut down**.

 **NOTE:** Ensure that the computer and all attached devices are turned off. If your computer and attached devices did not automatically turn off when you shut down your operating system, press and hold the power button for about 6 seconds to turn them off.

Before working inside your computer

1. Ensure that your work surface is flat and clean to prevent the computer cover from being scratched.
2. Turn off your computer.
3. If the computer is connected to a docking device (docked), undock it.
4. Disconnect all network cables from the computer (if available).

 **CAUTION:** If your computer has an RJ45 port, disconnect the network cable by first unplugging the cable from your computer.

5. Disconnect your computer and all attached devices from their electrical outlets.
6. Open the display.
7. Press and hold the power button for few seconds, to ground the system board.

 **CAUTION:** To guard against electrical shock unplug your computer from the electrical outlet before performing Step # 8.

 **CAUTION:** To avoid electrostatic discharge, ground yourself by using a wrist grounding strap or by periodically touching an unpainted metal surface at the same time as touching a connector on the back of the computer.

8. Remove any installed ExpressCards or Smart Cards from the appropriate slots.

After working inside your computer

After you complete any replacement procedure, ensure that you connect external devices, cards, and cables before turning on your computer.

 **CAUTION:** To avoid damage to the computer, use only the battery designed for this particular Dell computer. Do not use batteries designed for other Dell computers.

1. Connect any external devices, such as a port replicator or media base, and replace any cards, such as an ExpressCard.
2. Connect any telephone or network cables to your computer.

 **CAUTION:** To connect a network cable, first plug the cable into the network device and then plug it into the computer.

3. Connect your computer and all attached devices to their electrical outlets.
4. Turn on your computer.

Disassembly and reassembly

SD card

Removing SD card

1. Follow the procedure in [Before working inside your computer](#).
2. Press in on the SD card to release it from the computer.



3. Remove the SD card from the computer.

Installing SD card

1. Slide the SD card into its slot until it clicks into place.
2. Follow the procedure in [After working inside your computer](#).

Battery cover

Removing the battery cover

1. Follow the procedure in [Before working inside your computer](#).
2. To remove the battery cover:
 - a) Slide the release latch towards the unlock icon to release the battery cover [1].
 - b) Slide and lift the battery cover to remove it from the computer [2].



Installing the battery cover

1. Slide the battery cover into its slot until it clicks into place.
2. Follow the procedure in [After working inside your computer](#).

Battery

Lithium-ion battery precautions

CAUTION:

- Exercise caution when handling Lithium-ion batteries.
- Discharge the battery as much as possible before removing it from the system. This can be done by disconnecting the AC adapter from the system to allow the battery to drain.
- Do not crush, drop, mutilate, or penetrate the battery with foreign objects.
- Do not expose the battery to high temperatures, or disassemble battery packs and cells.
- Do not apply pressure to the surface of the battery.
- Do not bend the battery.
- Do not use tools of any kind to pry on or against the battery.
- Ensure any screws during the servicing of this product are not lost or misplaced, to prevent accidental puncture or damage to the battery and other system components.
- If a battery gets stuck in a device as a result of swelling, do not try to free it as puncturing, bending, or crushing a Lithium-ion battery can be dangerous. In such an instance, contact for assistance and further instructions.
- If the battery gets stuck inside your computer as a result of swelling, do not try to release it as puncturing, bending, or crushing a lithium-ion battery can be dangerous. In such an instance, contact Dell technical support for assistance. See www.dell.com/contactdell.
- Always purchase genuine batteries from www.dell.com or authorized Dell partners and resellers.

Removing the battery

1. Follow the procedure in [Before working inside your computer](#).
2. Remove the [battery cover](#).
3. To remove battery:
 - a) Slide the release latch towards from the unlock icon to unlock the battery[1].
 - b) Lift and remove the battery from the computer [2].

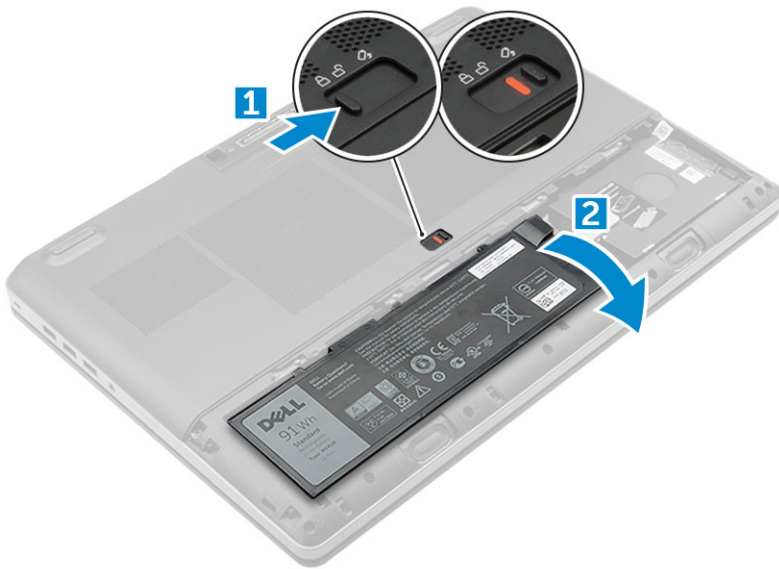

Installing the battery

1. Slide the battery into its slot until it clicks into place.
2. Install the [battery cover](#).
3. Follow the procedure in [After working inside your computer](#)

Hard drive

Removing the hard drive

1. Follow the procedure in [Before working inside your computer](#).
2. Remove the:
 - a) [battery cover](#)
 - b) [battery](#)
3. To remove hard drive:
 - a) Remove the M3.0x3.0 screws that secure the hard drive to the computer [1].
 - b) Lift the hard drive latch to release the hard drive [2].
 - c) Slide and lift the hard drive from the computer [3].

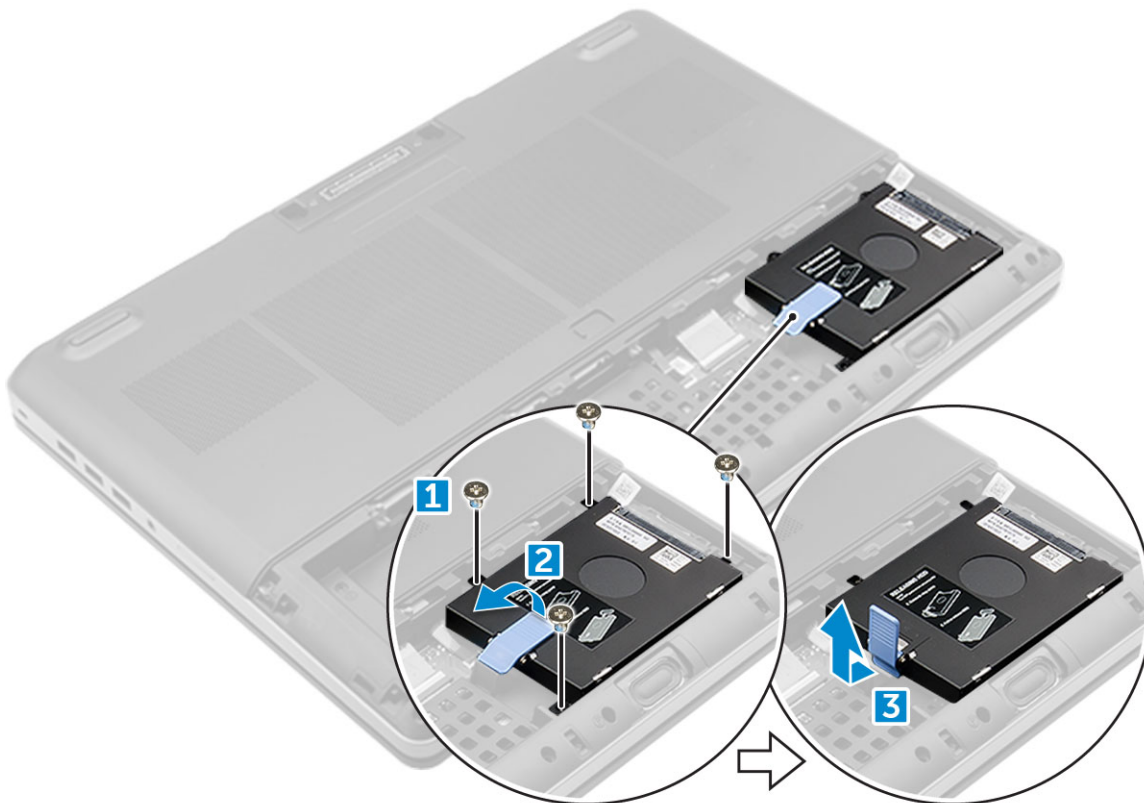

4. Remove the M3.0x3.0 screws that secure the hard drive. Lift the hard drive from the bracket.

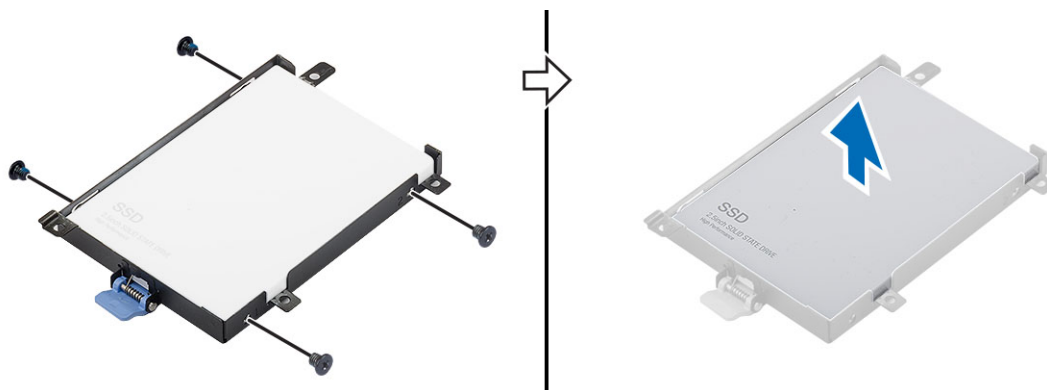

Installing the hard drive

1. Replace the M3.0x3.0 screws to secure the hard drive to the hard drive bracket.
2. Insert the hard drive into its slot in the computer.
3. Replace the M3.0x3.0 screws to secure the hard drive to the computer.
4. Install the:
 - a) [battery](#)
 - b) [battery cover](#)
5. Follow the procedure in [After working inside your computer](#).

Hard drive cable connector

Removing the hard drive cable connector

1. Follow the procedures in [Before working inside your computer.](#)
2. Remove the:
 - a) [battery cover](#)
 - b) [battery](#)
 - c) [base cover](#)
 - d) [hard drive](#)
3. To remove the hard drive cable connector:
 - a) Remove the M2.5x5.0 screws that secure the hard drive connector to the system board [1].
 - b) Remove the hard drive cable connector from the computer [2].

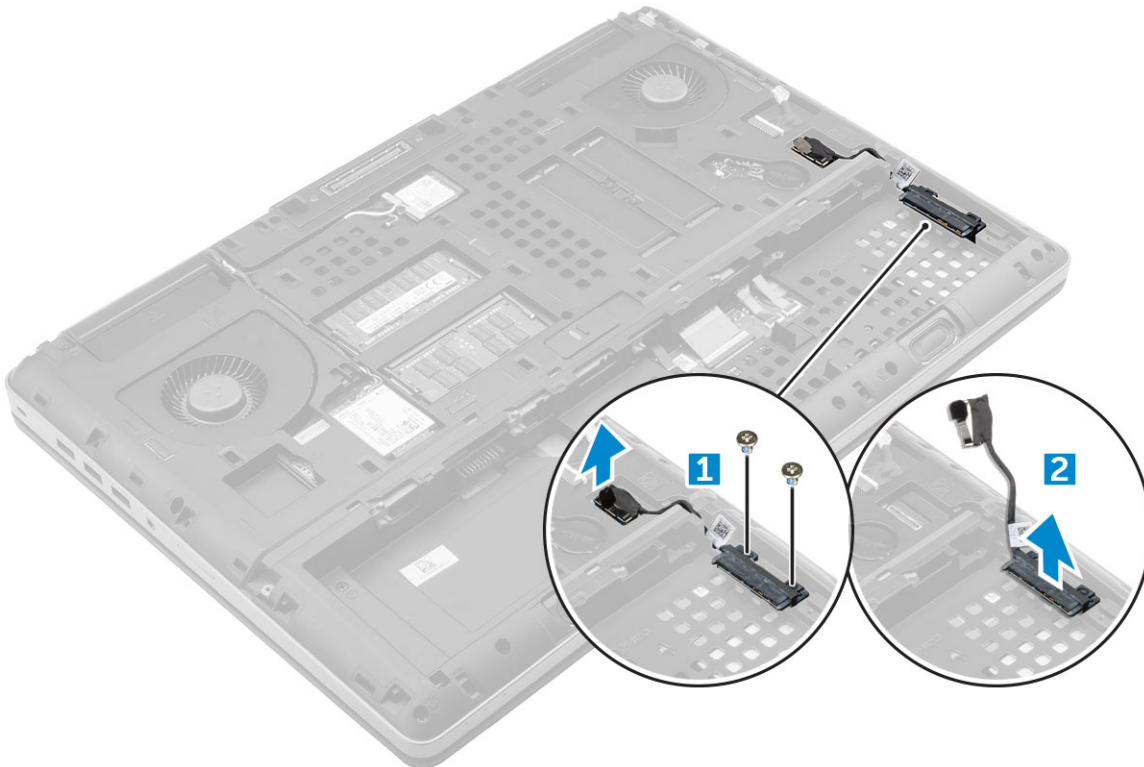

Installing the hard drive cable connector

1. Connect the hard drive cable to the system board.
2. Insert and route the cable through the routing channel.
3. Replace the M2.5x5.0 screws to secure the hard drive cable connector to the computer.
4. Install the:
 - a) [hard drive](#)
 - b) [base cover](#)
 - c) [battery](#)
 - d) [battery cover](#)
5. Follow the procedure in [After working inside your computer.](#)

Keyboard lattice and Keyboard

Removing the keyboard

1. Follow the procedures in [Before working inside your computer](#).
2. Remove the:
 - a) [battery cover](#)
 - b) [battery](#)
 - c) [hard drive](#)
3. To remove keyboard cable:

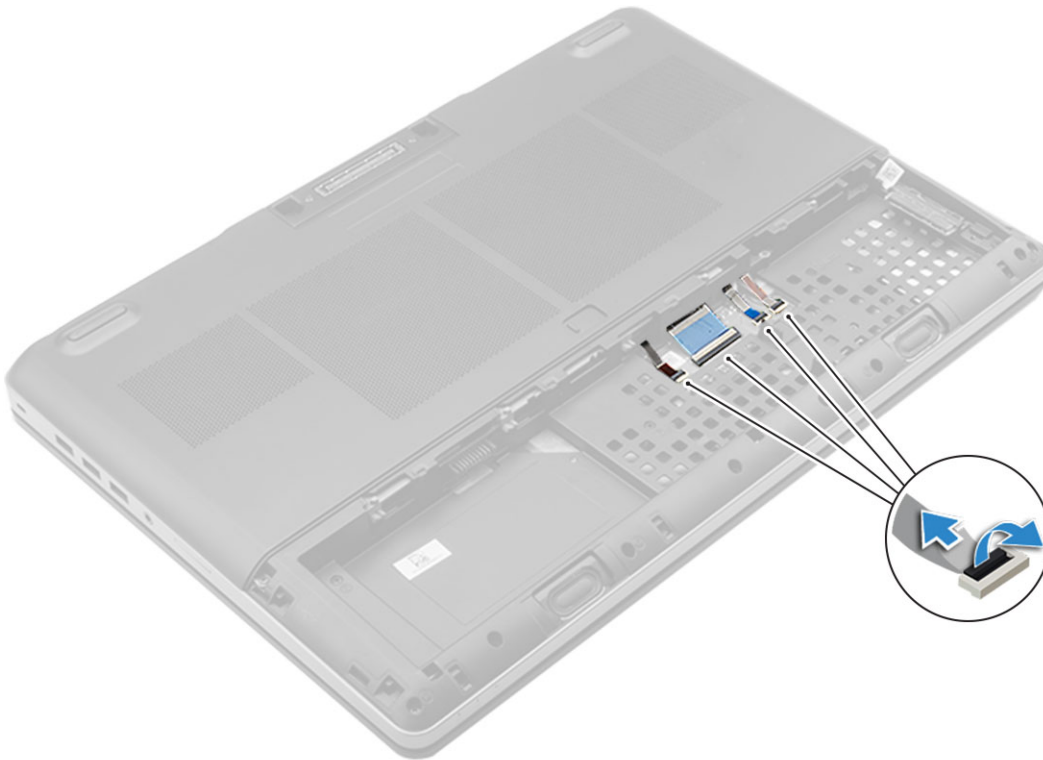

- a) Disconnect the keyboard cables from the touchpad board [1, 2]
4. Using plastic scribe pry the keyboard trim from the bottom and work along the top edge and remove it from the computer [1, 2, 3, 4].

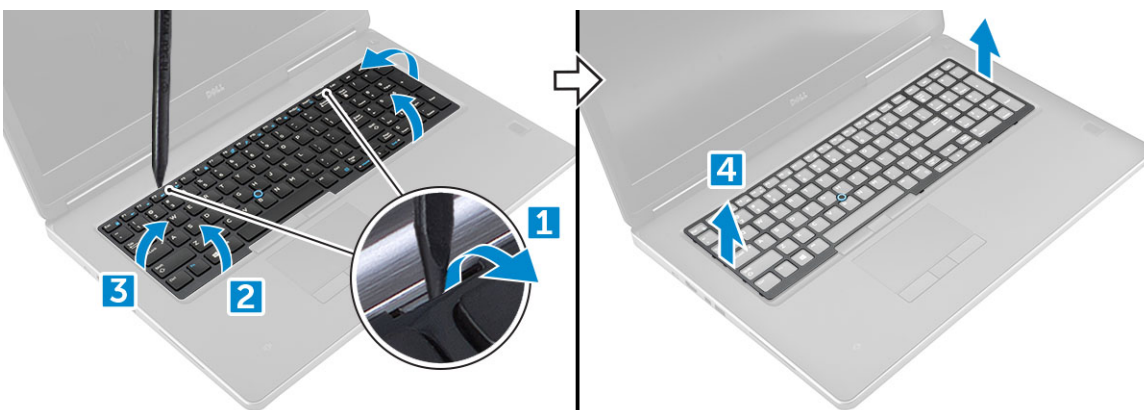

5. To remove the keyboard:
 - a) Remove the M2.0x2.5 screws that secure the keyboard to the computer [1].
 - b) Lift and slide the keyboard to remove it away from the computer [2, 3].

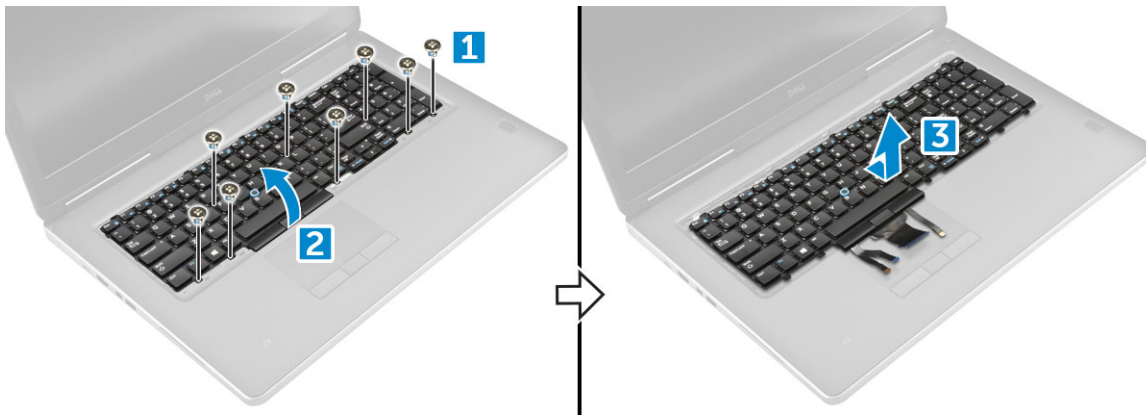

Installing the keyboard

1. Align the keyboard and route the cables back through to the bottom of the compartment.
2. Press and align the keyboard to its compartment.
3. Replace the screws to secure the keyboard to the computer.
4. Slide the keyboard trim and align it to its position on the computer. Ensure that the keyboard trim clicks into its place.
5. Connect the keyboard data cables to the touchpad board.

NOTE: Ensure that you fold the keyboard data cable in perfect alignment.

6. Install the:
 - a) [hard drive](#)
 - b) [battery](#)
 - c) [battery cover](#)
7. Follow the procedure in [After working inside your computer](#).

Memory modules

Removing the primary memory module

1. Follow the procedure in [Before working inside your computer](#).
2. Remove the:
 - a) [battery cover](#)
 - b) [battery](#)
 - c) [base cover](#)
3. To remove primary memory module:
 - a) Pry the retention clips away from the memory module until it pops up.
 - b) Lift the memory module and remove it from the computer.

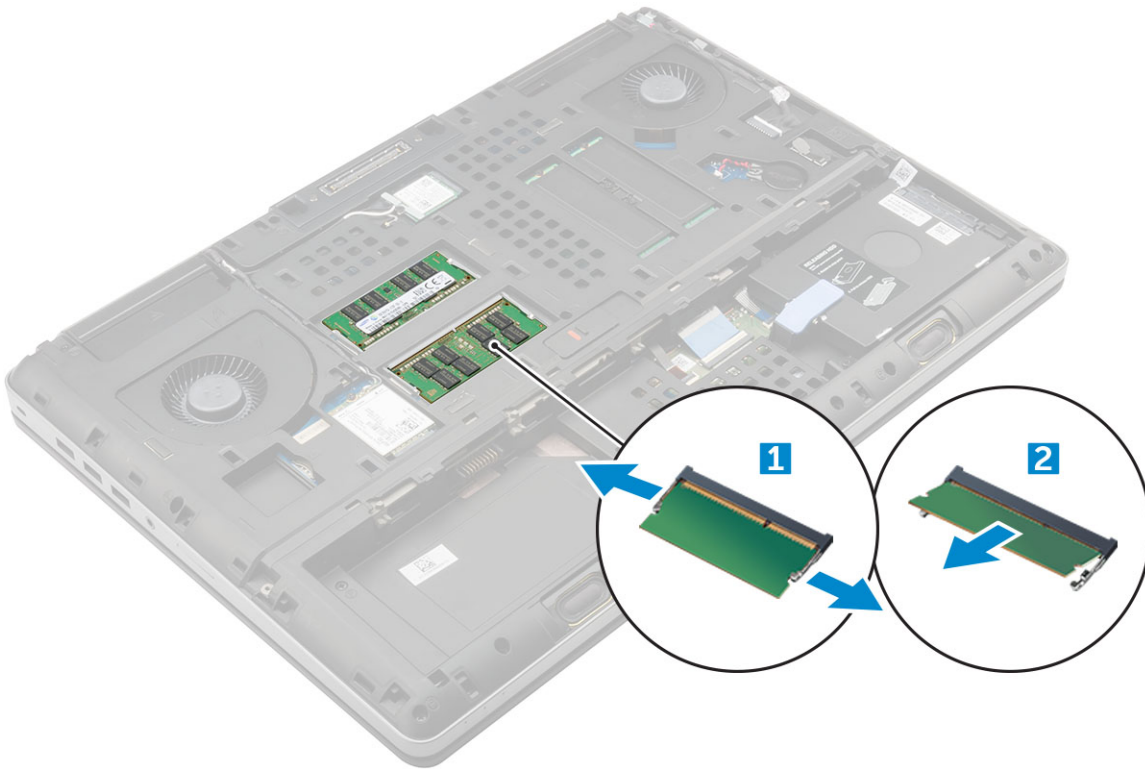

Installing the primary memory module

1. Insert the memory module into the memory socket.

i **NOTE:** Installing one or three memory modules leads to system performance issues.

2. Press the clips to secure the memory module to the system board.
3. Install the:
 - a) [base cover](#)
 - b) [battery](#)
 - c) [battery cover](#)
4. Follow the procedure in [After working inside your computer](#).

Removing the secondary memory module

1. Follow the procedure in [Before working inside your computer](#).
2. Remove the:
 - a) [battery cover](#)
 - b) [battery](#)
 - c) [hard drive](#)
 - d) [keyboard](#)
3. To remove the secondary memory module:
 - a) Remove the screw that secures the memory shield [1].
 - b) Lift and remove the memory shield from the computer [2].
 - c) Pry the retention clips away from the memory module until it pops up [3].
 - d) Lift the memory module and remove it from the computer [4].

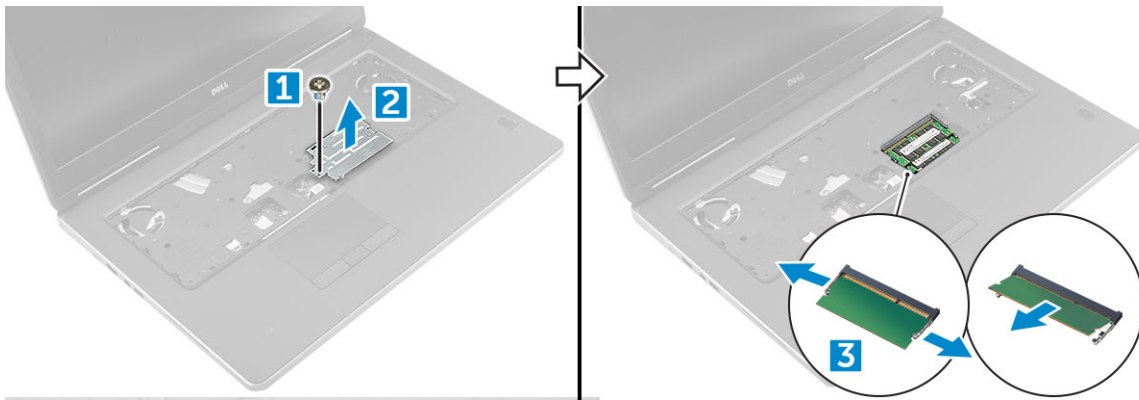

Installing the secondary memory module

1. Insert the memory module into the memory socket.
2. Press the clips to secure the memory module to the system board.
3. Place the memory shield in its original position on the memory module and tighten the screw to secure it to the computer.
4. Install the:
 - a) keyboard
 - b) hard drive
 - c) battery
 - d) battery cover
5. Follow the procedure in [After working inside your computer](#).

Base cover

Removing the base cover

1. Follow the procedure in [Before working inside your computer](#).
2. Remove the:
 - a) battery cover
 - b) battery
3. To remove base cover:
 - a) Remove the M2.5X5.0 screws that secure the base cover to the computer [1].
 - b) Slide and lift the base cover away from the computer [2].

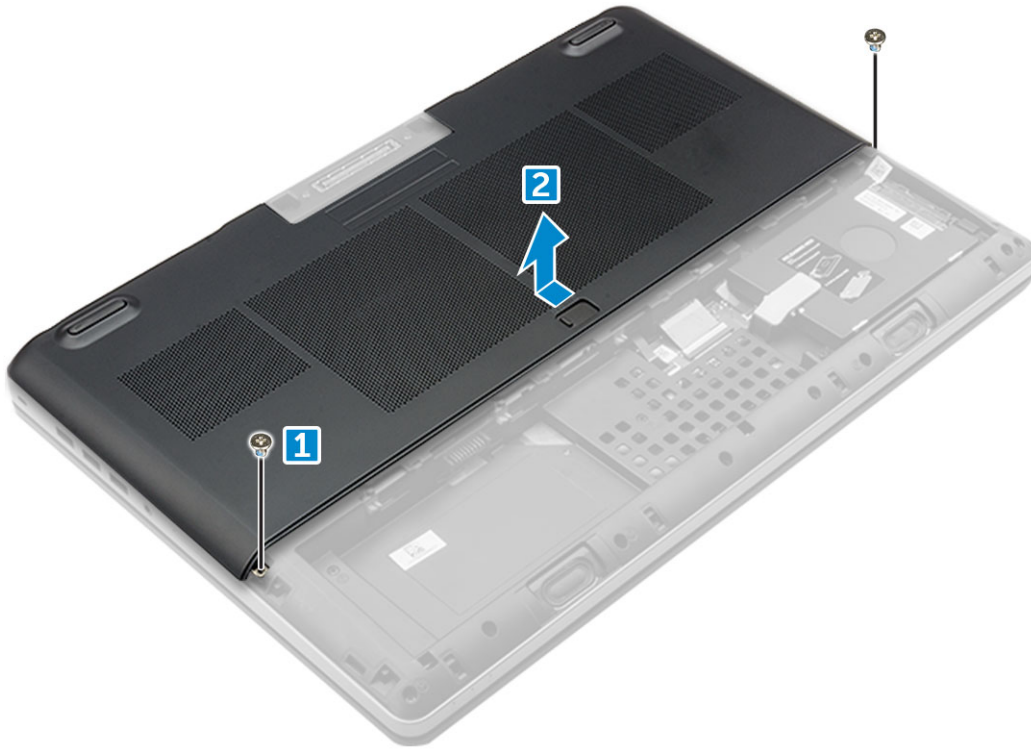

Installing the base cover

1. Slide the base cover to align with the screw holes on the computer.
2. Replace the M2.5X5.0 screws to secure the base cover to the computer.
3. Install the:
 - a) battery
 - b) battery cover
4. Follow the procedure in [After working inside your computer](#).

WWAN card

Removing Wireless Wide Area Network - WWAN card

NOTE: Depending on the configuration you choose, you may or may not have WWAN card.

1. Follow the procedure in [Before working inside your computer](#).
2. Remove the:
 - a) battery cover
 - b) battery
 - c) base cover
3. To remove the WWAN card:
 - a) Disconnect and unroute the antenna cables connected to the WWAN card [1].
 - b) Remove the M2.0x3.0 screw that secures the WWAN card to the computer [2].
 - c) Remove the WWAN card from the computer [3].

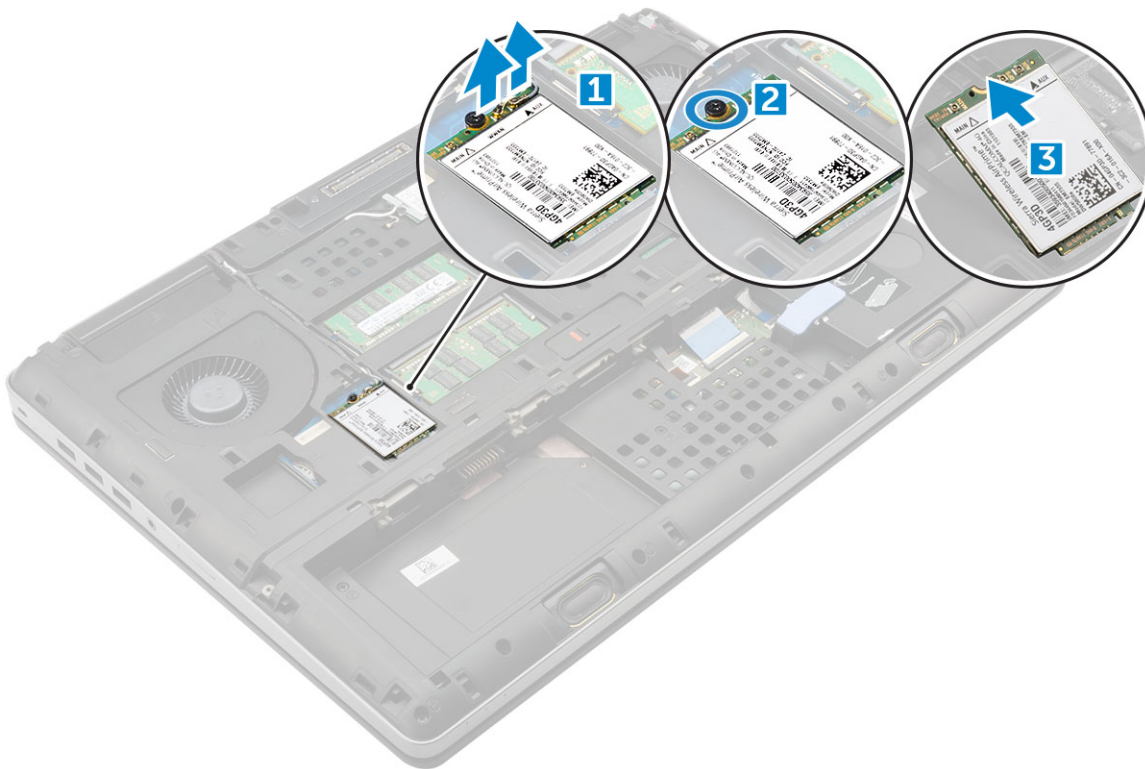

Installing the WWAN card

NOTE: Depending on the configuration you choose, you may or may not have WWAN card.

1. Slide the WWAN card to the WWAN card slot.
2. Replace the M2.0x3.0 screw to secure the WWAN card to the computer.
3. Route the antenna cables through the routing channels and connect them to the WWAN card.
4. Install the:
 - a) [base cover](#)
 - b) [battery](#)
 - c) [battery cover](#)
5. Follow the procedure in [After working inside your computer](#).

WLAN card

Removing the Wireless Local Area Network - WLAN card

1. Follow the procedure in [Before working inside your computer](#).
2. Remove the:
 - a) [battery cover](#)
 - b) [battery](#)
 - c) [base cover](#)
3. To remove the WLAN card from the computer:
 - a) Remove the M2.0x3.0 screw that secures the WLAN card to the computer [1].
 - b) Remove the shield that secures the antenna cables [2].
 - c) Disconnect and un-route the antenna cables connected to the WLAN card and remove the WLAN card from the computer [3,4].

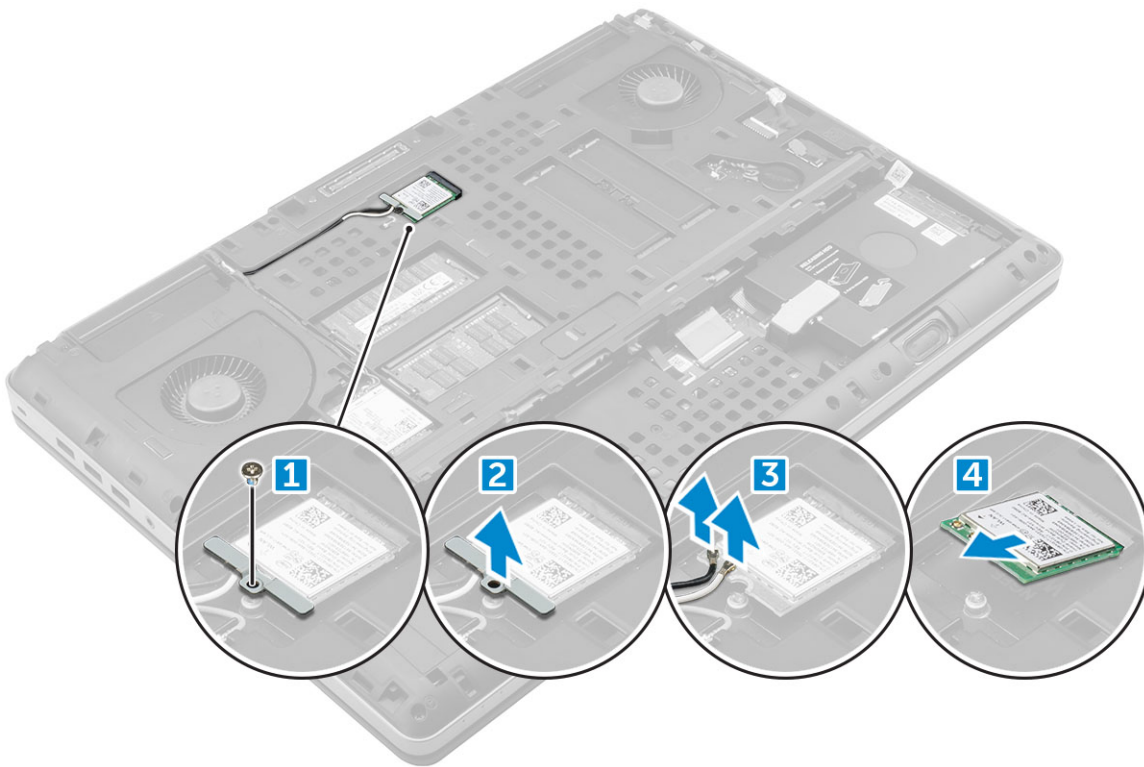

Installing the WLAN Card

1. Insert the WLAN card in its slot on the computer.
2. Route the antenna cables through the routing channel and connect them to the WLAN card.
3. Align the shield and tighten the M2.0x3.0 screw to secure the WLAN card to the computer.
4. Install the:
 - a) [base cover](#)
 - b) [battery](#)
 - c) [battery cover](#)
5. Follow the procedures in [After working inside your computer](#).

Solid State Drive

Removing the M.2 Solid State Drive -SSD module

1. Follow the procedures in [Before working inside your computer](#).
2. Remove the:
 - a) [battery cover](#)
 - b) [battery](#)
 - c) [base cover](#)
3. To remove the SSD module:
 - a) Remove the M2.0x3.0 screw that secures the thermal plate to the computer.
 - b) Remove the thermal plate from the computer.
 - c) Remove the M2.0x3.0 screw that secures the SSD to the computer.
 - d) Remove the SSD away from the computer.

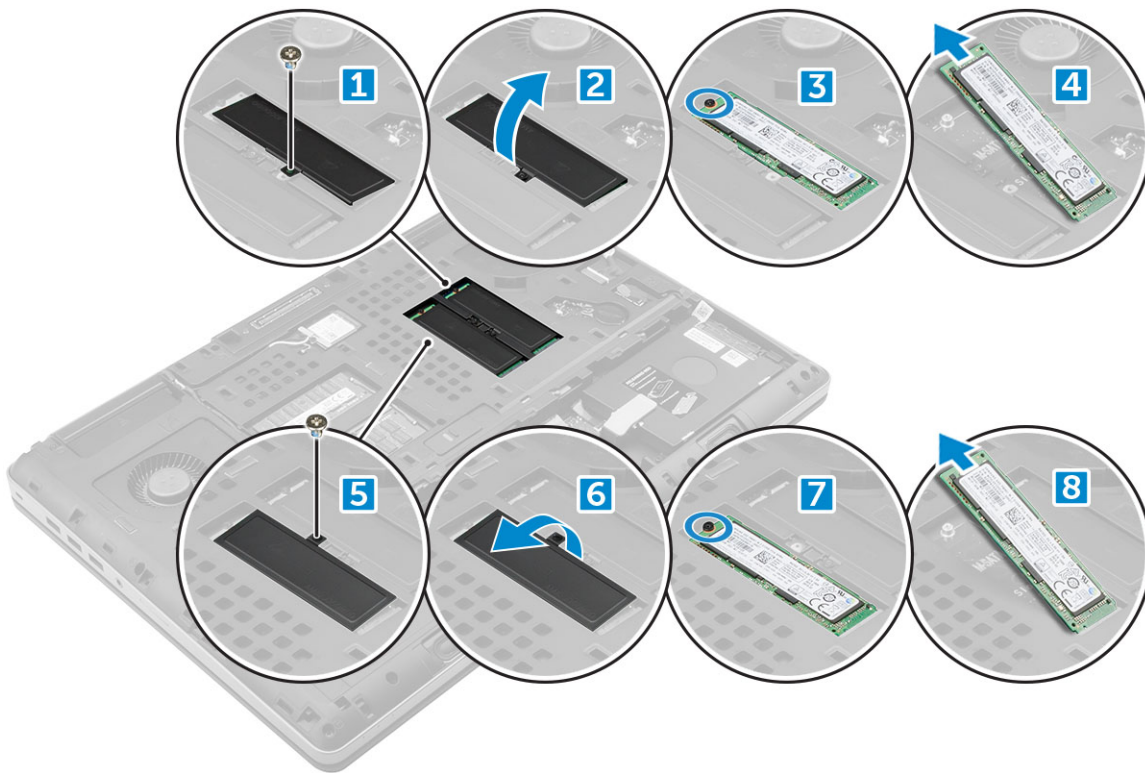

Installing the M.2 SSD module

1. Place the SSD in its slot.
2. Replace the M2.0x3.0 screw to secure the SSD to the computer.
3. Place the thermal plate on the SSD.
4. Replace the M2.0x3.0 screw to secure the thermal plate to the computer.
5. Install the:
 - a) [base cover](#)
 - b) [battery](#)
 - c) [battery cover](#)
6. Follow the procedure in [After working inside your computer](#).

Coin-cell battery

Removing the coin cell battery

1. Follow the procedures in [Before working inside your computer](#).
2. Remove the:
 - a) [battery cover](#)
 - b) [battery](#)
 - c) [base cover](#)
3. To remove coin cell battery:
 - a) Disconnect the coin cell battery cable from the computer [1].
 - b) Pry and lift the coin cell battery from the computer [2].

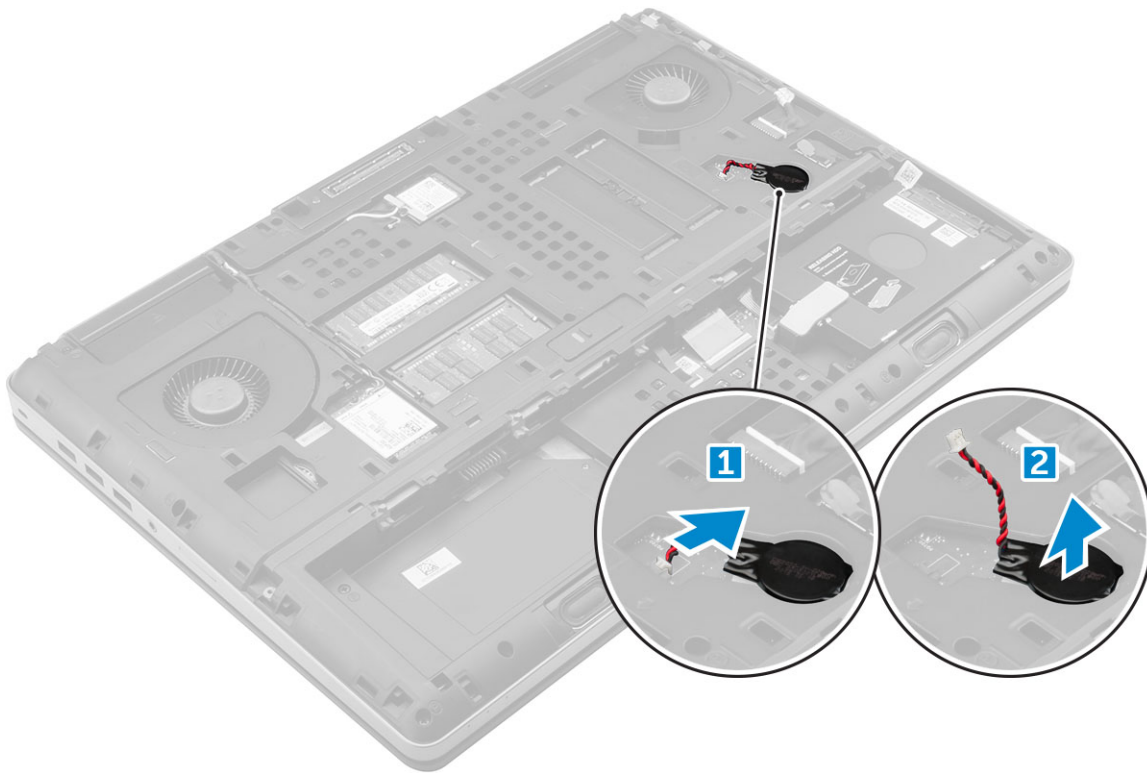

Installing the coin cell battery

1. Replace the coin cell battery in its slot on the computer.
2. Connect the coin cell battery cable to the computer.

i **NOTE:** Ensure that the coin cell battery cable does not protrude outside its compartment.

3. Install the:
 - a) [base cover](#)
 - b) [battery](#)
 - c) [battery cover](#)
4. Follow the procedure in [After working inside your computer](#).

Power connector port

Removing the power connector port

1. Follow the procedure in [Before working inside your computer](#).
2. Remove the:
 - a) [battery cover](#)
 - b) [battery](#)
 - c) [base cover](#)
3. To remove power connector port:
 - a) Disconnect the power connector cable from the computer [1].
 - b) Remove the M2.5x5.0 screw to remove the bracket from the computer [2].
 - c) Remove the bracket from the computer [3].
 - d) Lift the power connector port from the computer [4].

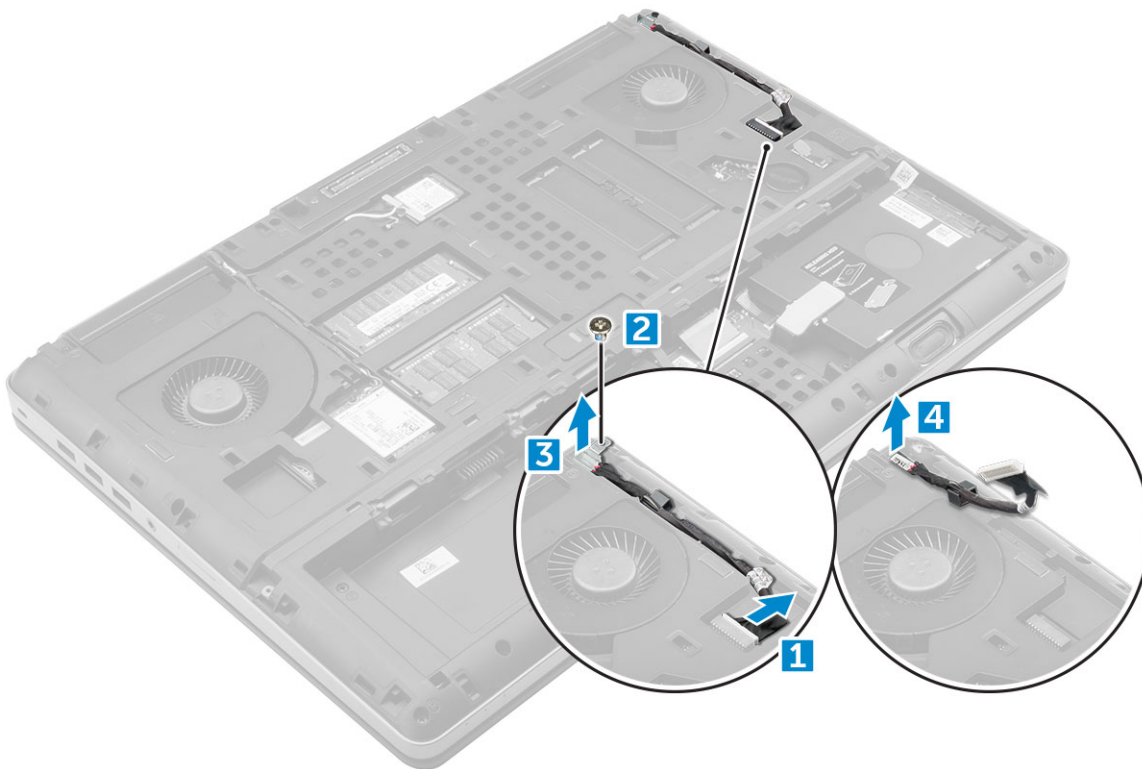

Installing the power connector port

1. Replace the power connector cable on the computer.
2. Route the cable through the routing channel
3. Replace the bracket.
4. Replace the M2.5x5.0 screw to secure the power connector port to the computer.
5. Connect the power connector cable.
6. Install the:
 - a) [base cover](#)
 - b) [battery](#)
 - c) [battery cover](#)
7. Follow the procedure in [After working inside your computer](#).

Palm rest

Removing the palmrest

1. Follow the procedure in [Before working inside your computer](#).
2. Remove the:
 - a) [battery cover](#)
 - b) [battery](#)
 - c) [base cover](#)
 - d) [hard drive](#)
 - e) [keyboard](#)
3. Remove the 15 screws (M2.5x5.0, M2.0x3.0) at the bottom of the computer which secure the palmrest to the computer .

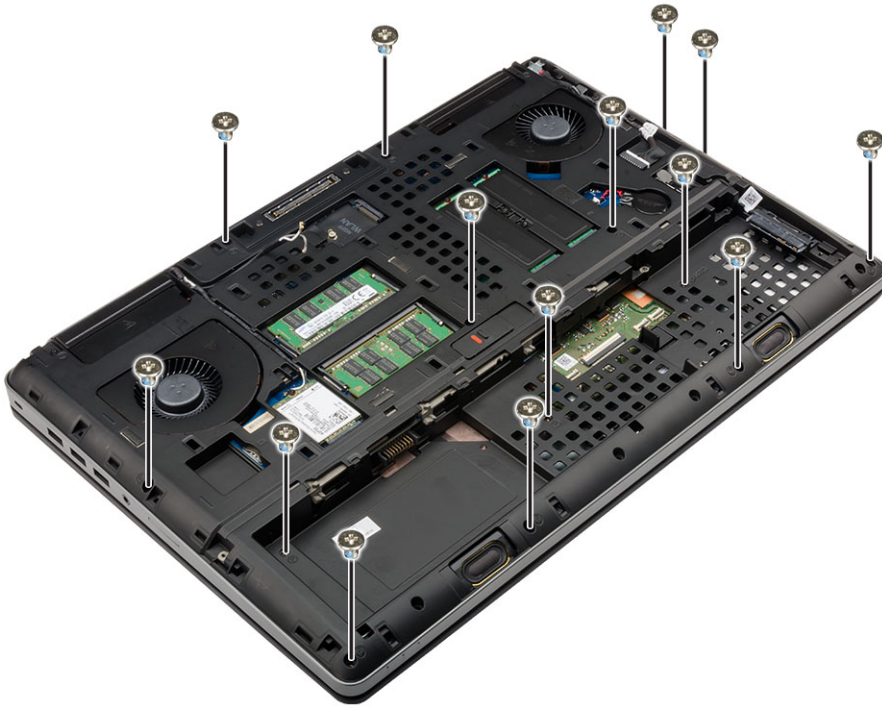

4. To remove palmrest:

- a) Lift the tab and disconnect the fan cable [1] and system board cable [2].
- b) Remove the 11 screws (M2.5x5.0)that secure the palmrest to the computer [3].
- c) By using plastic scribe release the tabs on the edges of the palmrest and remove the palmrest from the computer [4].

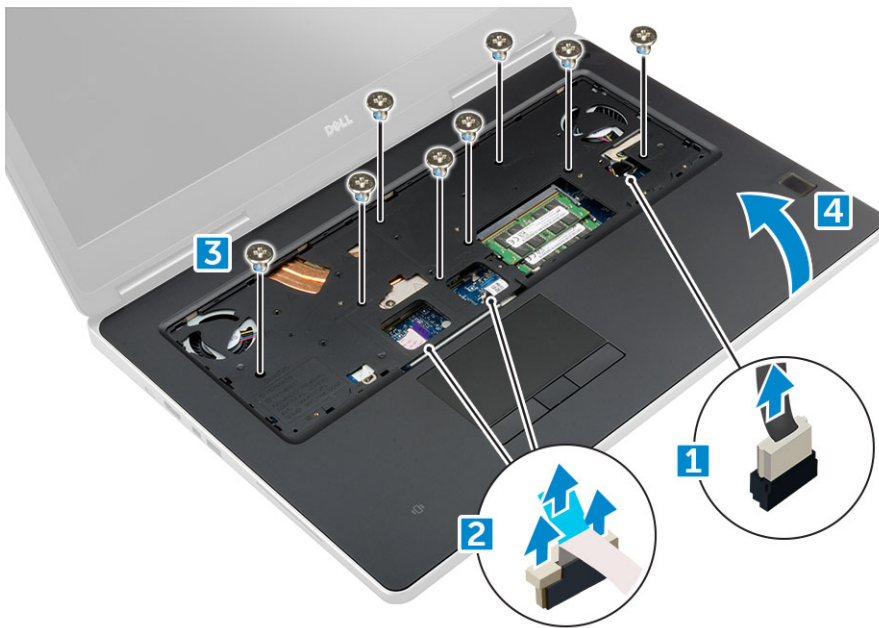

Installing the palmrest

- 1. Align the palmrest on the computer and press until it snaps in its place.
- 2. Replace the 11 screws (M2.5x5.0) that secure the palmrest to the computer.
- 3. Connect the following cables:
 - a) system board cable
 - b) fan cable

4. Flip the computer and tighten the 15 screws (M2.5x5.0, M2.0x3.0) at the bottom of the computer.
5. Install the:
 - a) keyboard
 - b) hard drive
 - c) base cover
 - d) battery
 - e) battery cover
6. Follow the procedure in [After working inside your computer](#).

Fingerprint reader

Removing the fingerprint reader

1. Follow the procedure in [Before working inside your computer](#).
2. Remove the:
 - a) SD card
 - b) battery cover
 - c) battery
 - d) base cover
 - e) hard drive
 - f) keyboard
 - g) hard drive cable
 - h) secondary memory
 - i) primary memory
 - j) WLAN card
 - k) WWAN card
 - l) M.2 SSD card
 - m) graphic card
 - n) power connector port
 - o) palmrest
3. To remove fingerprint reader:
 - a) Peel the adhesive tape that secures fingerprint reader [1].
 - b) Remove and lift the M2.0X3 screws that secure metal bracket on the chassis [2].
 - c) Disconnect the cable and lift the fingerprint reader from the chassis [3].

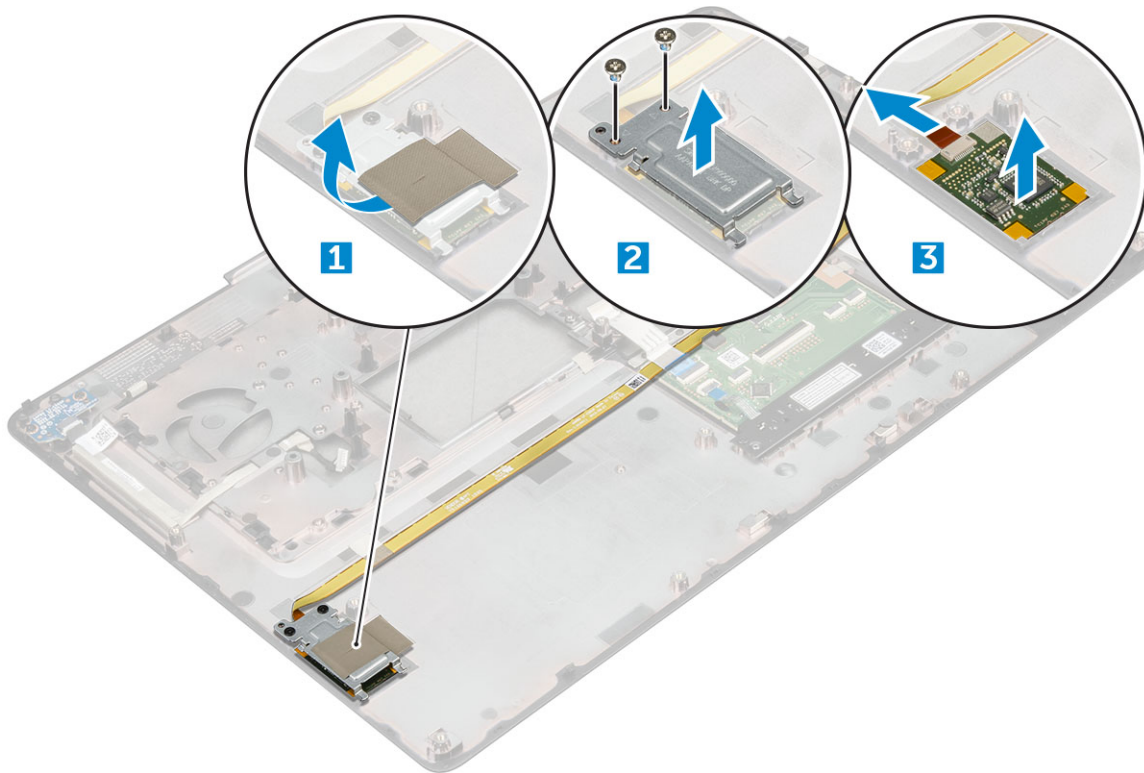

Installing the fingerprint reader

1. Align the fingerprint reader into its original position on the chassis.
2. Connect the finger print reader cable.
3. Place the metal bracket on the chassis.
4. Replace the M2.0X3 screws to secure the fingerprint reader to the chassis.
5. Affix the adhesive tape to secure the fingerprint reader.
6. Install the:
 - a) palmrest
 - b) power connector port
 - c) graphic card
 - d) M.2 SSD card
 - e) WWAN card
 - f) WLAN card
 - g) primary memory
 - h) secondary memory
 - i) HDD cable
 - j) keyboard
 - k) hard drive
 - l) base cover
 - m) battery
 - n) battery cover
 - o) SD card
7. Follow the procedure in [After working inside your computer](#).

Power switch board

Removing the power switch board

1. Follow the procedure in [Before working inside your computer](#).
2. Remove the:
 - a) [battery cover](#)
 - b) [battery](#)
 - c) [base cover](#)
 - d) [hard drive](#)
 - e) [keyboard](#)
 - f) [palmrest](#)
3. To remove power switch board:
 - a) Disconnect the power switch board cable from the computer [1].
 - b) Remove the M2.0X3 screws that secure power switch board to the computer [2].
 - c) Remove the power switch board from the computer [3].

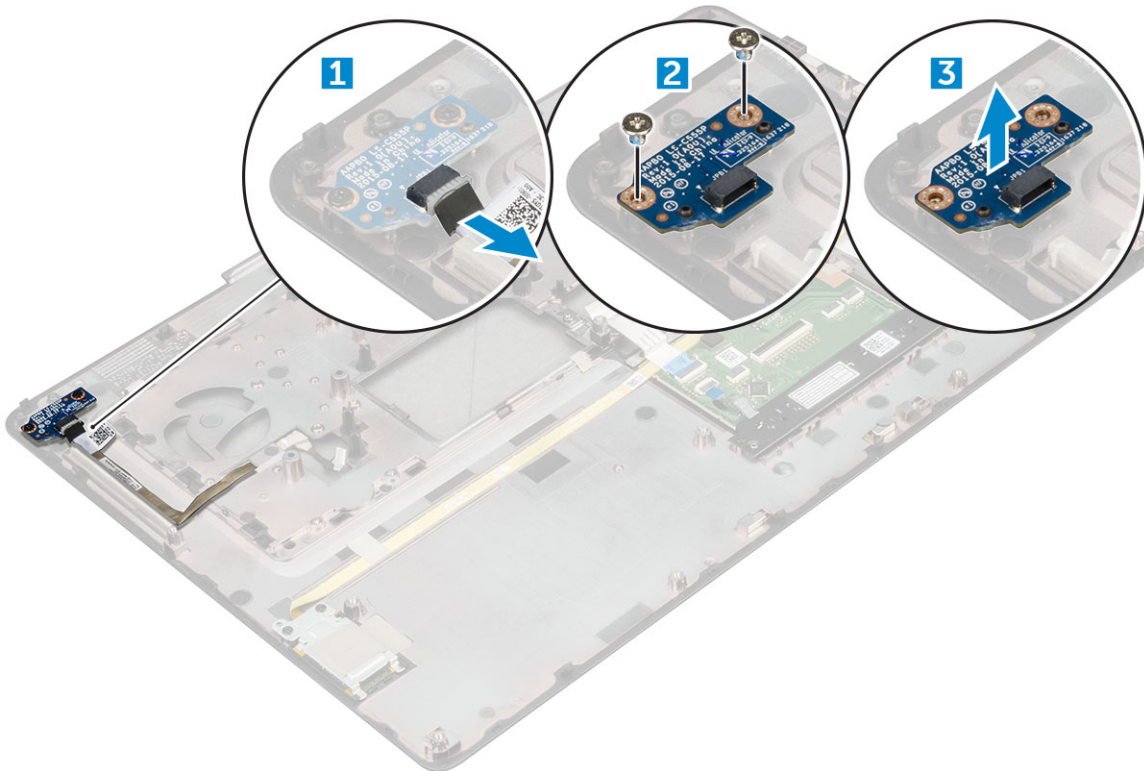

Installing the power switch board

1. Place the power switch in the slot on the computer.
2. Replace the M2.0X3 screws that secure power switch board on the computer.
3. Connect the power switch board cable on the computer.
4. Install the:
 - a) [palmrest](#)
 - b) [keyboard](#)
 - c) [hard drive](#)
 - d) [base cover](#)
 - e) [battery](#)
 - f) [battery cover](#)
5. Follow the procedure in [After working inside your computer](#).

ExpressCard Reader

Removing the expresscard

1. Follow the procedure in [Before working inside your computer](#).
2. Remove the:
 - a) [battery cover](#)
 - b) [battery](#)
 - c) [base cover](#)
 - d) [hard drive](#)
 - e) [keyboard](#)
 - f) [palmrest](#)
3. To remove expresscard:
 - a) Disconnect the expresscard cable from the computer [1].
 - b) Remove the M2.5x5.0 screws that secure expresscard to the computer [2].
 - c) Remove the expresscard board from the computer [3].

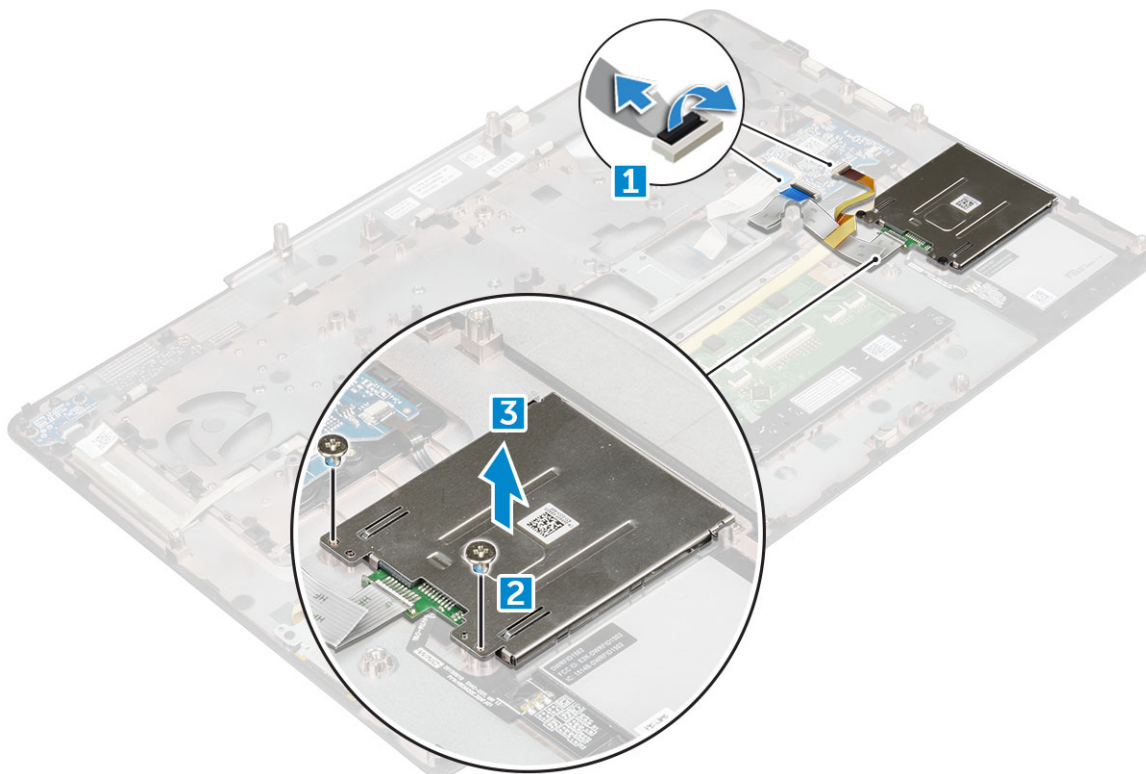

Installing the expresscard

1. Place the expresscard on the computer.
2. Replace the M2.5x5.0 screws that secure expresscard on the computer.
3. Connect the expresscard cable.
4. Install the:
 - a) [palmrest](#)
 - b) [keyboard](#)
 - c) [hard drive](#)
 - d) [base cover](#)
 - e) [battery](#)
 - f) [battery cover](#)

5. Follow the procedure in [After working inside your computer](#).

USB board

Removing the USB board

1. Follow the procedure in [Before working inside your computer](#).
2. Remove the:
 - a) [battery cover](#)
 - b) [battery](#)
 - c) [base cover](#)
 - d) [hard drive](#)
 - e) [keyboard](#)
 - f) [palmrest](#)
3. To remove USB board:
 - a) Disconnect the USB board cable from the computer [1].
 - b) Remove the adhesive tape that secures USB board to the computer [2].
 - c) Lift the USB board from the computer [3].

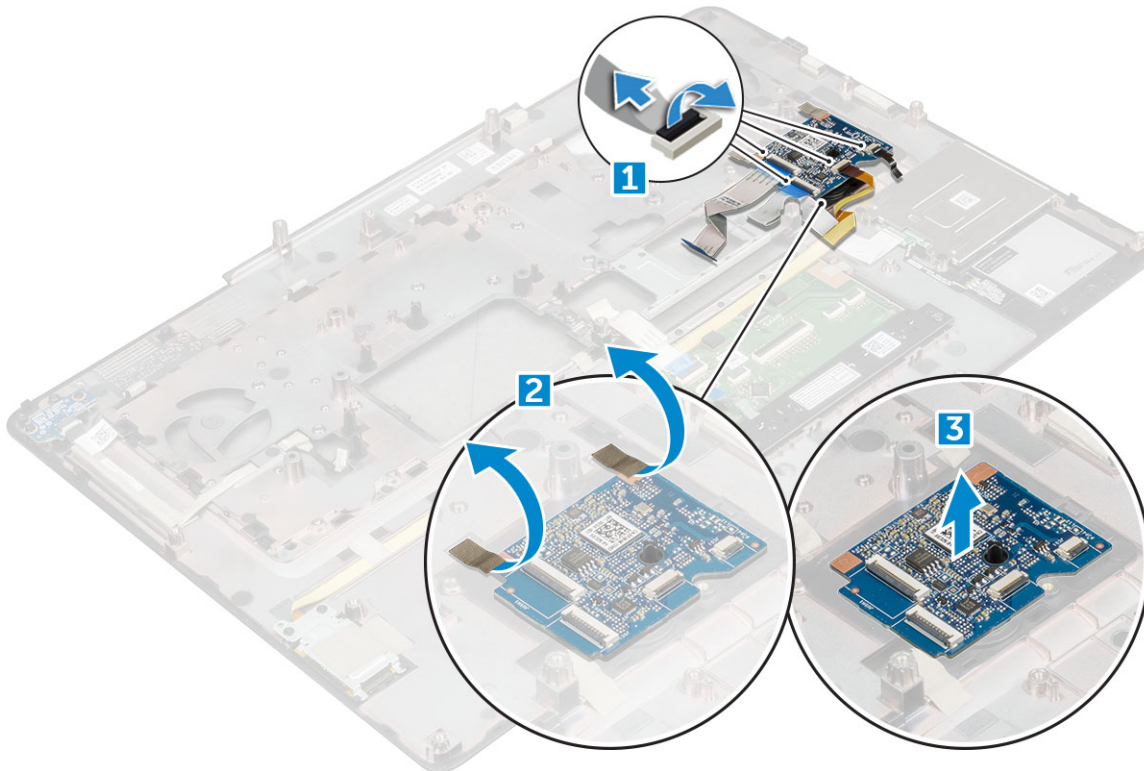

Installing the USB board

1. Place the USB board on the computer.
2. Affix the adhesive tape to secure the USB board on the computer
3. Connect the USB board cable.
4. Install the:
 - a) [palmrest](#)
 - b) [keyboard](#)
 - c) [hard drive](#)

- d) base cover
- e) battery
- f) battery cover

5. Follow the procedure in [After working inside your computer](#).

Input-Output board

Removing the left Input-Output -IO board

1. Follow the procedure in [Before working inside your computer](#).
2. Remove the:
 - a) battery cover
 - b) battery
 - c) base cover
 - d) hard drive
 - e) keyboard
 - f) palmrest
3. To remove I/O board:
 - a) Remove the M2.5x5.0 screws that secure the thunderbolt bracket to the computer [1].
 - b) Lift the bracket from the thunderbolt connector [2].
 - c) Remove the M2.5x5.0 screws that secure the I/O board to the computer [3].
 - d) Lift the I/O board upwards to and remove it from the computer.

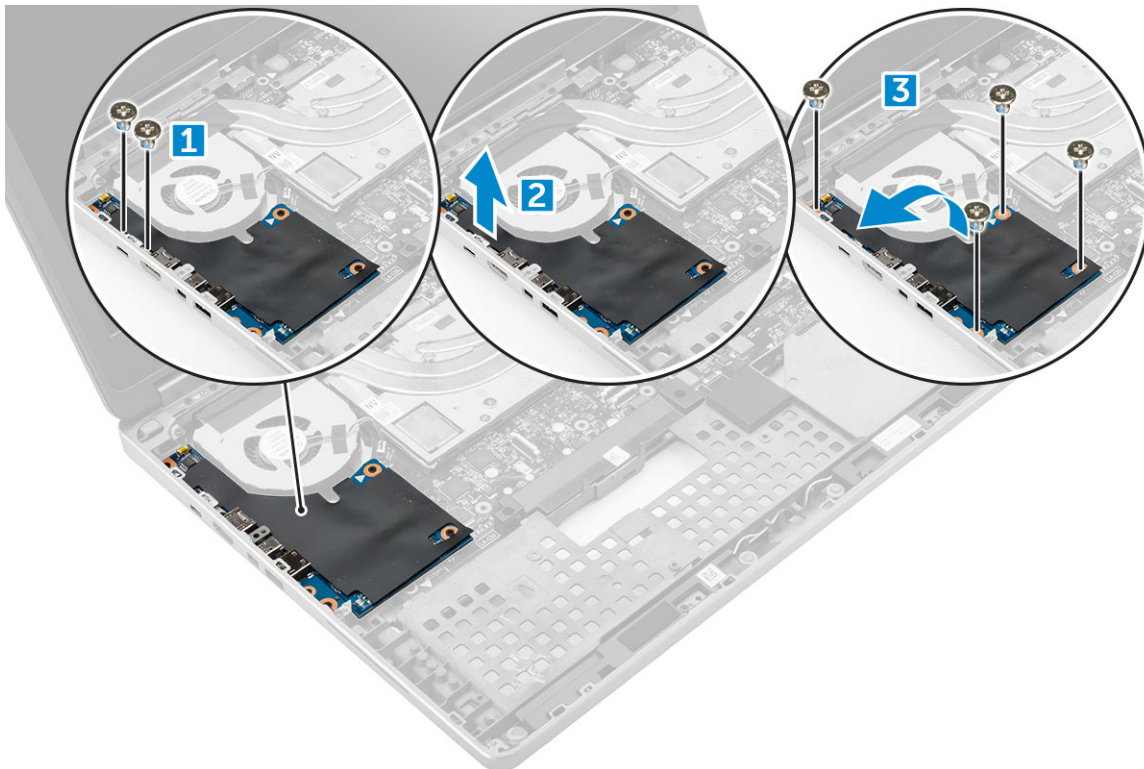

Installing the left IO board

1. Slide the I/O board into its slot on the computer.
2. Install the thunderbolt bracket.
3. Replace the M2.5x5.0 screws to secure the I/O board to the computer.
4. Install the:
 - a) palmrest

- b) keyboard
 - c) hard drive
 - d) base cover
 - e) battery
 - f) battery cover
5. Follow the procedures in [After working inside your computer](#).

Removing the right Input-Output - IO board

1. Follow the procedure in [Before working inside your computer](#).
2. Remove the:
 - a) SD card
 - b) battery cover
 - c) battery
 - d) base cover
 - e) hard drive
 - f) keyboard
 - g) palmrest
3. To remove I/O board:
 - a) Disconnect the right speaker cable from the I/O board [1].
 - b) Remove the M2.5x5.0 screws that secure the I/O board to the computer [2].
 - c) Lift the I/O board upwards to and remove it from the computer [3].

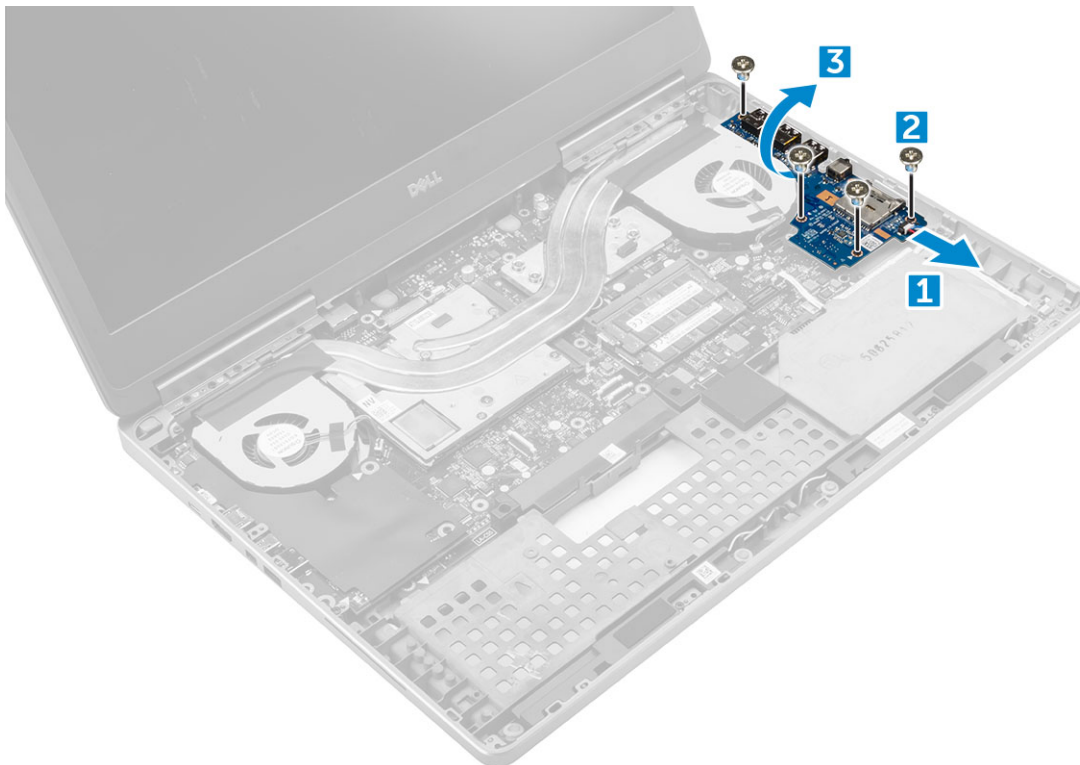

Installing the right IO board

1. Connect the I/O board connector cable and slide the I/O board into its slot on the computer.
2. Replace the M2.5x5.0 screws to secure the I/O board to the computer.
3. Connect the speaker cable to the I/O board.
4. Install the:
 - a) palmrest
 - b) keyboard

- c) hard drive
- d) base cover
- e) battery
- f) battery cover
- g) SD card

5. Follow the procedure in [After working inside your computer](#).

Heat sink

Removing the heat sink assembly

1. Follow the procedure in [Before working inside your computer](#).

2. Remove the:

- a) battery cover
- b) battery
- c) base cover
- d) hard drive
- e) keyboard
- f) palmrest

3. To remove heat sink:

- a) Disconnect the fan cables from the computer [1, 2].
- b) Loosen the captive M2.5x5.0 screws that secure the heat sink assembly to the computer [3].

NOTE: Remove the screws that secure the heat sink to the system board in the order stamped onto the heat sink next to the screws [1, 2, 3, 4, 5, 6, 7, 8].

- c) Lift and remove the heat sink assembly from the computer [4].

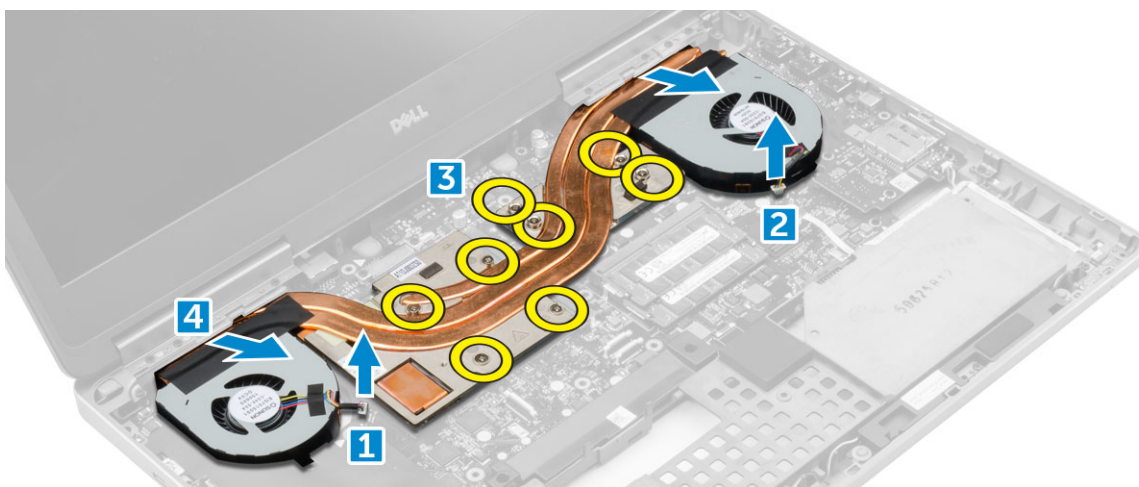

Installing the heat sink assembly

1. Insert the heat-sink assembly in its slot.

2. Tighten the captive M2.5x5.0 screws to secure the heat-sink assembly to the computer.

NOTE: Tighten the screws on the system board in the order stamped onto the heat sink next to the screws [1, 2, 3, 4, 5, 6, 7, 8].

3. Connect the fan cables to the system board.

4. Install the:

- a) palmrest
- b) keyboard
- c) hard drive
- d) base cover

- e) battery
 - f) battery cover
5. Follow the procedure in *After working inside your computer*.

Graphics card

Removing the graphic card

1. Follow the procedure in *Before working inside your computer*.
2. Remove the:
 - a) battery cover
 - b) battery
 - c) base cover
 - d) hard drive
 - e) keyboard
 - f) palmrest
 - g) heat sink
3. To remove the graphic card:
 - a) Remove the M2.0x3.0 screws that secure the graphic card to the computer [1].
 - b) Remove the graphic card from the computer [2].

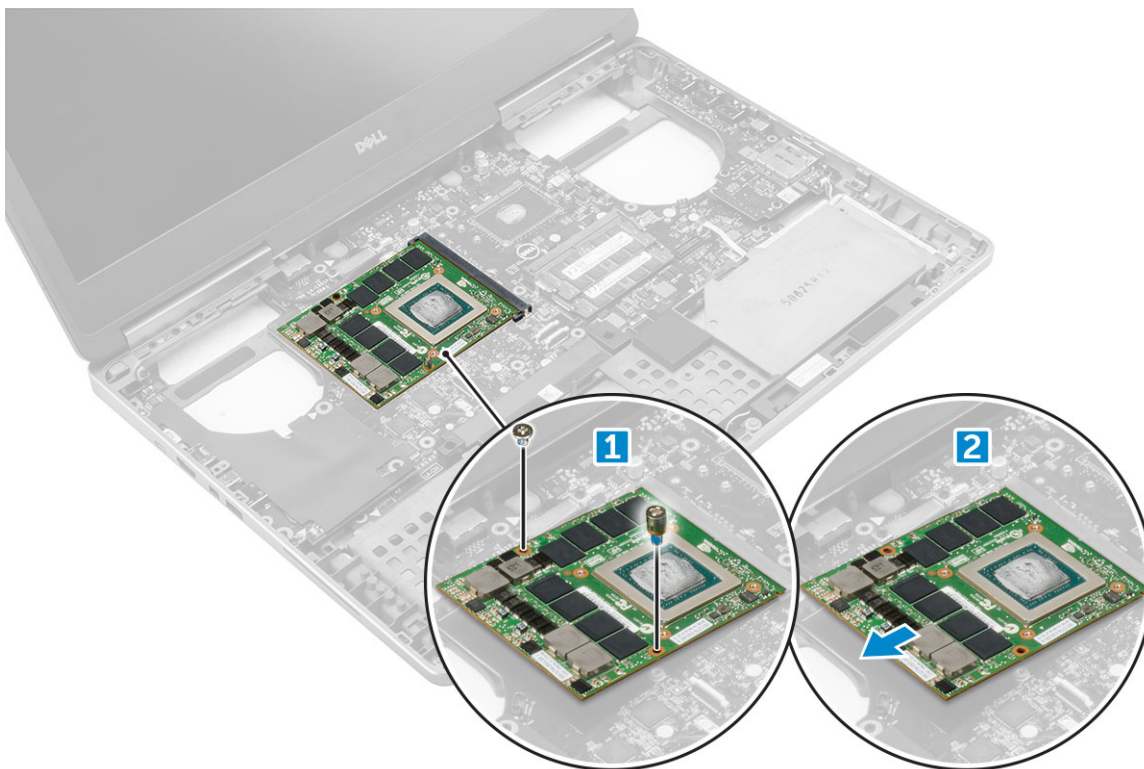

Installing the graphic card

1. Slide the graphic card into its original position in the computer.
2. Replace the M2.0x3.0 screws to secure the graphic card to the computer.
3. Install the:
 - a) heat sink
 - b) palmrest
 - c) keyboard
 - d) hard drive

- e) [base cover](#)
 - f) [battery](#)
 - g) [battery cover](#)
4. Follow the procedure in [After working inside your computer](#).

System board

Removing the system board

1. Follow the procedure in [Before working inside your computer](#).
2. Remove the:
 - a) [SD card](#)
 - b) [battery cover](#)
 - c) [battery](#)
 - d) [base cover](#)
 - e) [hard drive](#)
 - f) [keyboard](#)
 - g) [hard drive cable](#)
 - h) [secondary memory](#)
 - i) [primary memory](#)
 - j) [WLAN card](#)
 - k) [WWAN card](#)
 - l) [M.2 SSD card](#)
 - m) [graphic card](#)
 - n) [power connector port](#)
 - o) [palmrest](#)
 - p) [I/O board \(left\)](#)
 - q) [I/O board \(right\)](#)
 - r) [heat sink](#)
3. To disconnect and remove the eDP cable:
 - a) Remove the M2.5x5.0 screws that secure the shield to the system board [1].
 - b) Lift the metal shield away from the eDP cable [2].
 - c) Disconnect the eDP cable [3].
 - d) Lift the tab and disconnect the power connector cable [4].

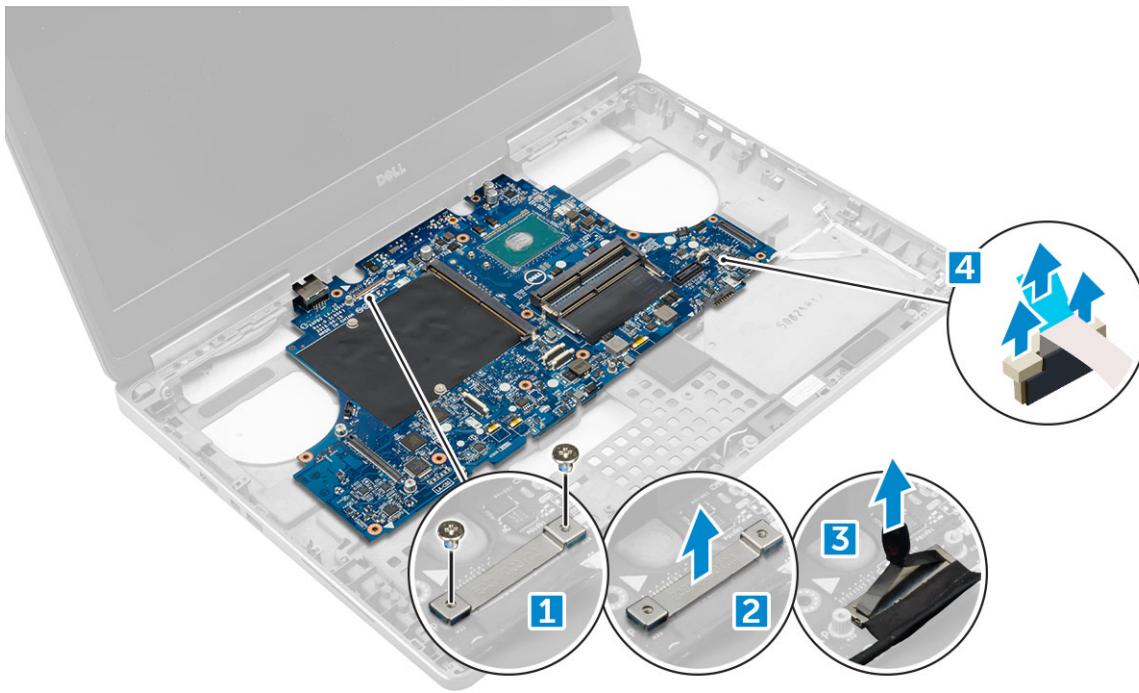

4. To remove system board:
 - a) Remove the M2.5X5.0 screws that secure the system board [1].
 - b) Slide and lift system board from the computer [2].

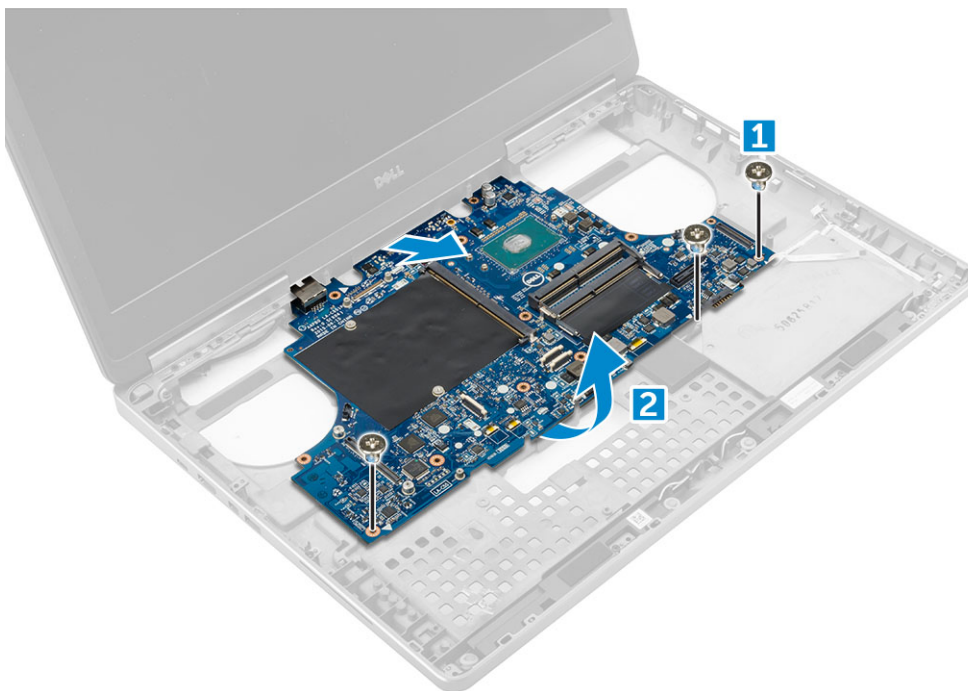

Installing the system board

1. Align the system board into its original position on the computer.
2. Replace the M2.5x5.0 screws to secure the system board to the computer.
3. Connect the following cables:
 - a) power connector
 - b) eDP
4. Place the metal bracket and tighten the M2.5x5.0 screw to secure the eDP cable to the computer.
5. Install the:

- a) heat sink
 - b) I/O board (right)
 - c) I/O board (left)
 - d) palmrest
 - e) power connector port
 - f) graphic card
 - g) M.2 SSD card
 - h) WWAN card
 - i) WLAN card
 - j) primary memory
 - k) secondary memory
 - l) HDD cable
 - m) keyboard
 - n) hard drive
 - o) base cover
 - p) battery
 - q) battery cover
 - r) SD card
6. Follow the procedure in [After working inside your computer](#).

LED board

Removing the LED board

1. Follow the procedures in [Before working inside your computer](#).
2. Remove the:
 - a) battery cover
 - b) battery
 - c) base cover
 - d) hard drive
 - e) keyboard
 - f) secondary memory
 - g) palmrest
3. To remove LED board:
 - a) Lift the tab and disconnect the LED-board cable from the LED board [1].
 - b) Remove the M2.0x3.0 screw that secures the LED board to the computer and remove it from the computer [2].

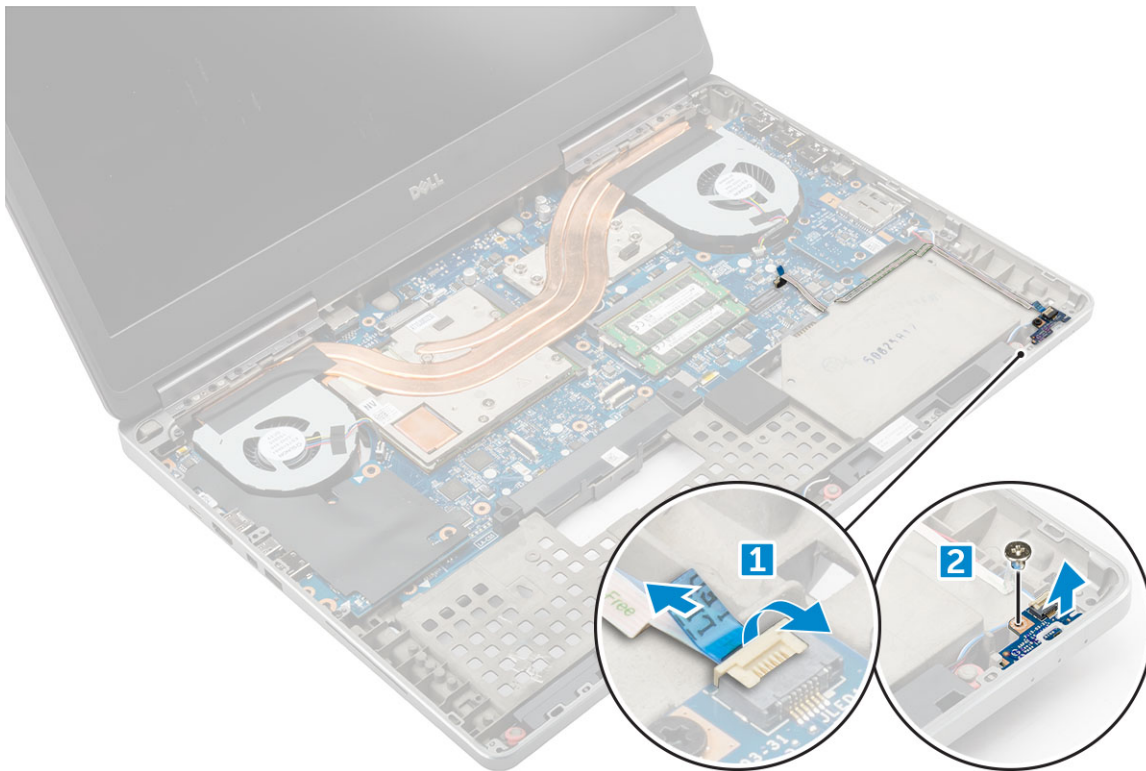

Installing the LED board

1. Align the LED board to its original position on the computer.
2. Replace the M2.0x3.0 screw to secure the LED board to the computer.
3. Connect the LED-board cable to the LED board and secure it through the routing channel.
4. Install the:
 - a) palmrest
 - b) secondary memory
 - c) keyboard
 - d) hard drive
 - e) base cover
 - f) battery
 - g) battery cover
5. Follow the procedure in [After working inside your computer](#).

Speaker

Removing the speakers

1. Follow the procedure in [Before working inside your computer](#).
2. Remove the:
 - a) battery cover
 - b) battery
 - c) base cover
 - d) hard drive
 - e) keyboard
 - f) palmrest
3. To remove the speaker:
 - a) Disconnect the speaker cable from the system board [1].

- b) Unroute the speaker cable and remove the cable from the routing tabs.
- c) Lift the speakers, along with the speaker cable and remove it away from the computer [2].



Installing the speakers

1. Align the speakers along the slots on the computer.
2. Route the speaker cable through the routing tabs on the computer.
3. Connect the speaker cable to the system board.
4. Install the:
 - a) palmrest
 - b) keyboard
 - c) hard drive
 - d) base cover
 - e) battery
 - f) battery cover
5. Follow the procedure in [After working inside your computer](#).

Display assembly

Removing the display assembly

1. Follow the procedure in [Before working inside your computer](#).
2. Remove the:
 - a) battery cover
 - b) battery
 - c) base cover
 - d) hard drive
 - e) keyboard
 - f) WLAN card
 - g) WWAN card

h) palmrest

3. To remove hinge cap:

- a) Remove the M2.5x4.0 screws that secure the hinge caps [1].
- b) Remove the hinge caps from the computer [2].

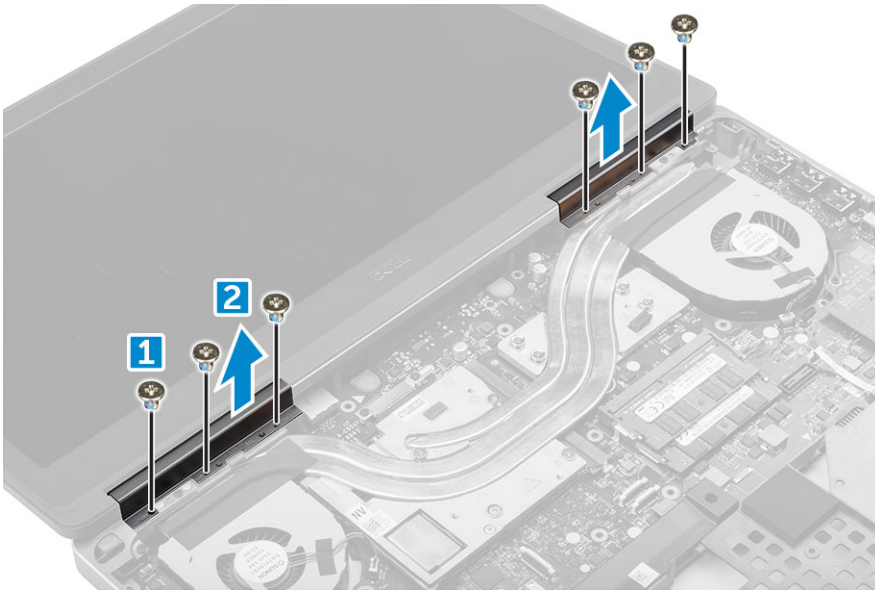

4. To disconnect antenna cables:

- a) Flip the computer and remove the M2.0X3 screws from the computer [1].
- b) Pull the antenna cables through the routing hole [2].

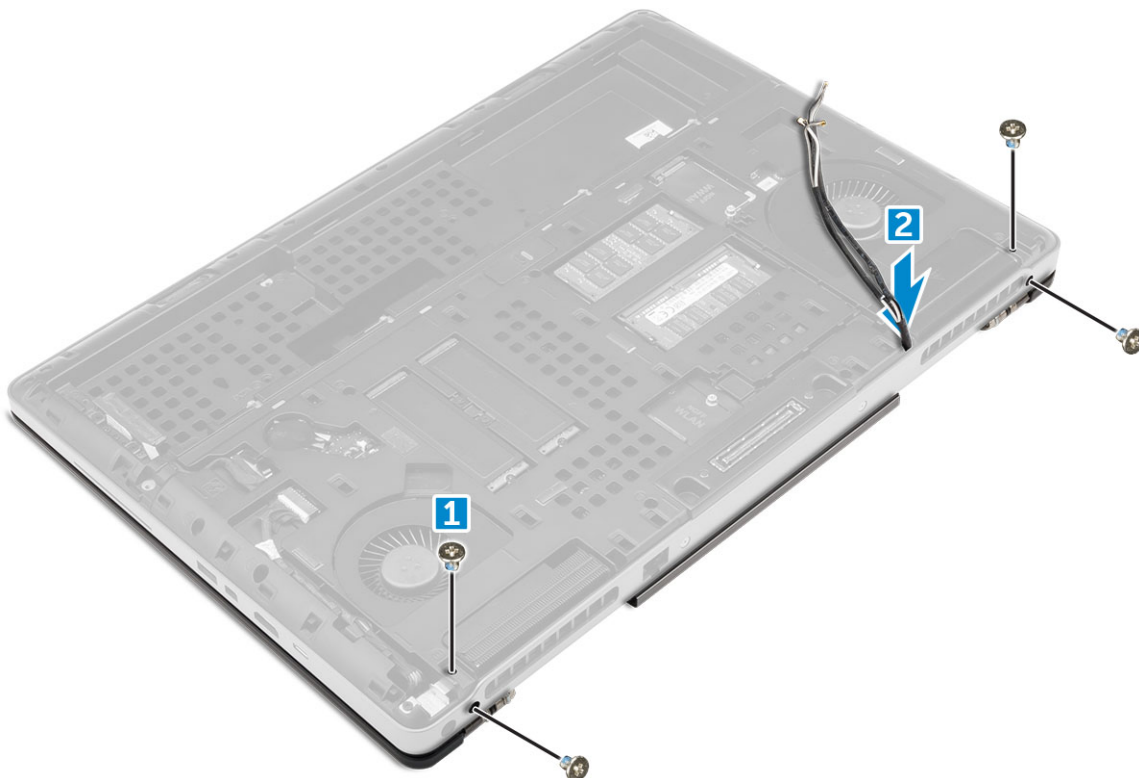

5. To remove display assembly:

- a) Flip the computer and open the display.
- b) Remove the M2.0X3 screw that secures the eDP cable bracket [1].
- c) Remove the eDP cable bracket [2].
- d) Peel off the tape on the heat sink and disconnect the eDP cable from the system board [3].
- e) Remove the M2.0X3 screws that secure the display assembly to the computer and remove it from the computer [4].

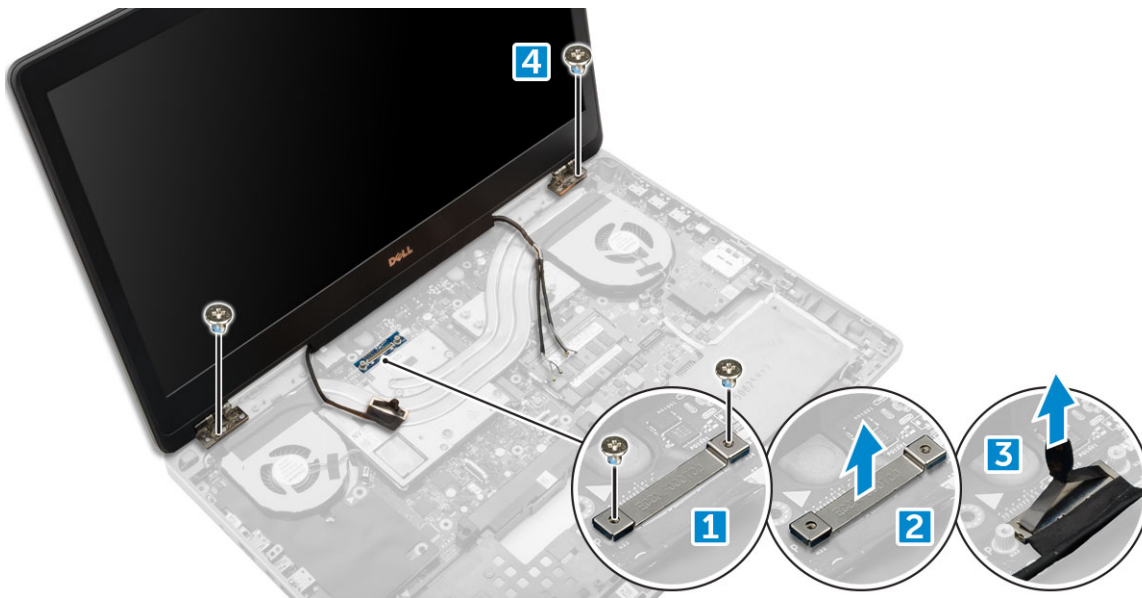

Installing the display assembly

1. Insert the display assembly into the slots on the computer.
2. Replace the M2.0X3 screws to secure the display assembly in place.
3. Affix the tape on the heat sink.
4. Connect the eDP cable to the connectors on the system board.
5. Insert the wireless antenna cables through the routing hole on the chassis.
6. Replace the display assembly M2.0X3 screws at the bottom and back of the computer.
7. Align the display hinge cap and tighten the M2.5x4.0 screws to secure it to the computer.
8. Connect the antenna cables to the connectors.
9. Install the:
 - a) [palmrest](#)
 - b) [WWAN card](#)
 - c) [WLAN card](#)
 - d) [keyboard](#)
 - e) [hard drive](#)
 - f) [base cover](#)
 - g) [battery](#)
 - h) [battery cover](#)
10. Follow the procedure in [After working inside your computer](#).

Display bezel

Removing the display bezel

1. Follow the procedure in [Before working inside your computer](#).
2. Remove the:
 - a) [battery cover](#)
 - b) [battery](#)
 - c) [base cover](#)
 - d) [hard drive](#)
 - e) [keyboard](#)
 - f) [palmrest](#)

- g) [display assembly](#)
- 3. To remove display bezel:
 - a) Pry up all the edges of the display bezel [1, 2, 3] using a plastic scribe.

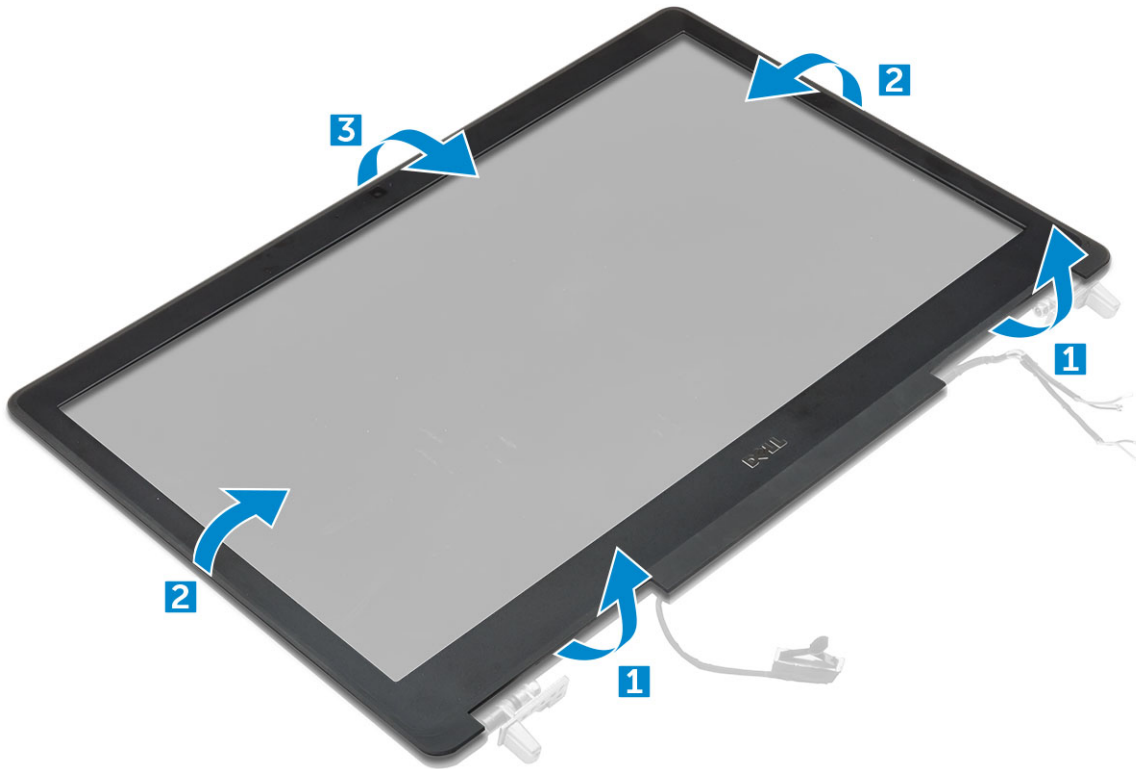

Installing the display bezel

1. Place the display bezel on the display assembly.
2. Press the edges of the display bezel until it clicks onto the display assembly.
3. Install the:
 - a) [display assembly](#)
 - b) [palmrest](#)
 - c) [keyboard](#)
 - d) [hard drive](#)
 - e) [base cover](#)
 - f) [battery](#)
 - g) [battery cover](#)
4. Follow the procedure in [After working inside your computer](#).

Display panel

Removing the display panel

1. Follow the procedure in [Before working inside your computer](#).
2. Remove the:
 - a) [battery cover](#)
 - b) [battery](#)
 - c) [base cover](#)
 - d) [hard drive](#)
 - e) [keyboard](#)

- f) palmrest
- g) display assembly
- h) display bezel

3. To remove screws from the display panel :

- a) Remove the M2.0X3 screws that secure the display panel to the display assembly [1].
- b) Lift the display panel and turn the display panel over to access the eDP cable [2].



4. To remove display panel:

- a) Peel the adhesive tape to access the eDP cable [1].
- b) Remove the blue adhesive tape [2].
- c) Lift the metal tab display panel [3].
- d) Disconnect the cable and lift the display panel.

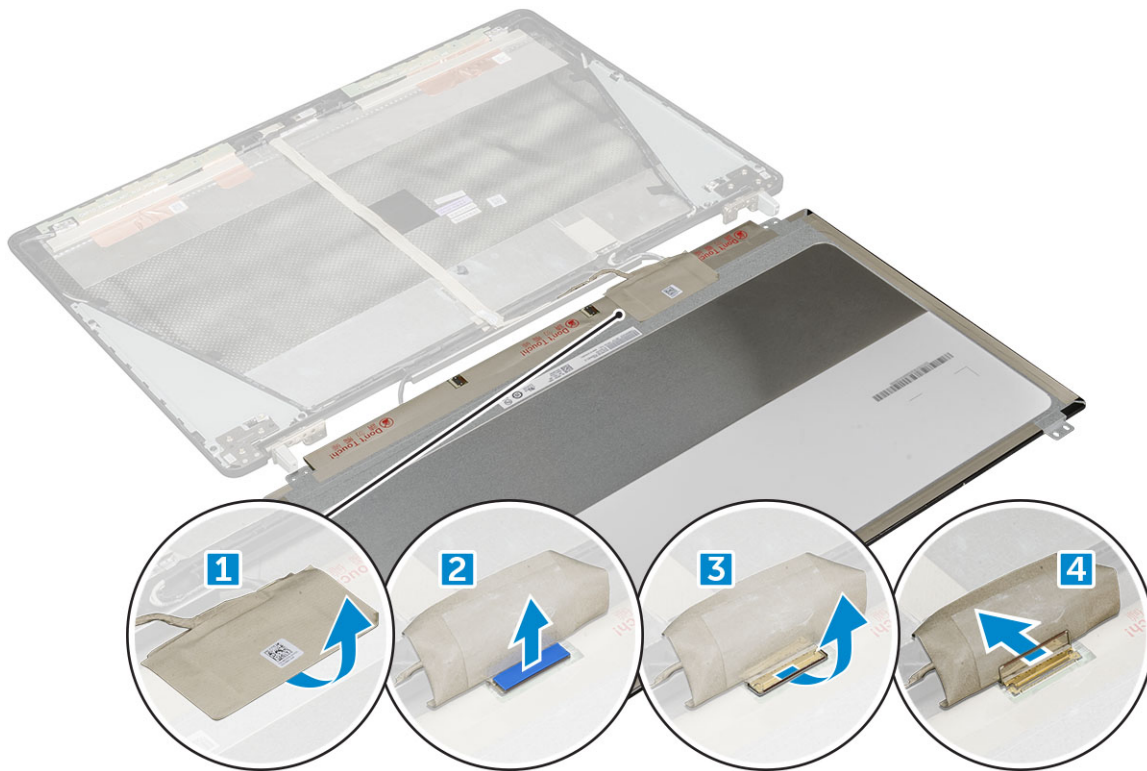

Installing the display panel

1. To install the display panel:
 - a) Connect the eDP cable to the connector on the back of the display panel and affix the adhesive tape.
 - b) Align the display panel with the tabs on the display assembly.
 - c) Replace the M2.0X3 screws to secure the display panel to the display assembly.
2. Install the:
 - a) display bezel
 - b) display assembly
 - c) palmrest
 - d) keyboard
 - e) hard drive
 - f) base cover
 - g) battery
 - h) battery cover
3. Follow the procedure in [After working inside your computer](#).

Removing the display panel

NOTE: For touch systems perform following step.

1. Follow the procedure in [Before working inside your computer](#).
2. Remove the:
 - a) battery cover
 - b) battery
 - c) base cover
 - d) hard drive
 - e) keyboard
 - f) palmrest
 - g) display assembly

h) display bezel

3. To remove the display panel:

a) Using a plastic scribe lift the edges of the display panel to disengage it from the display assembly.

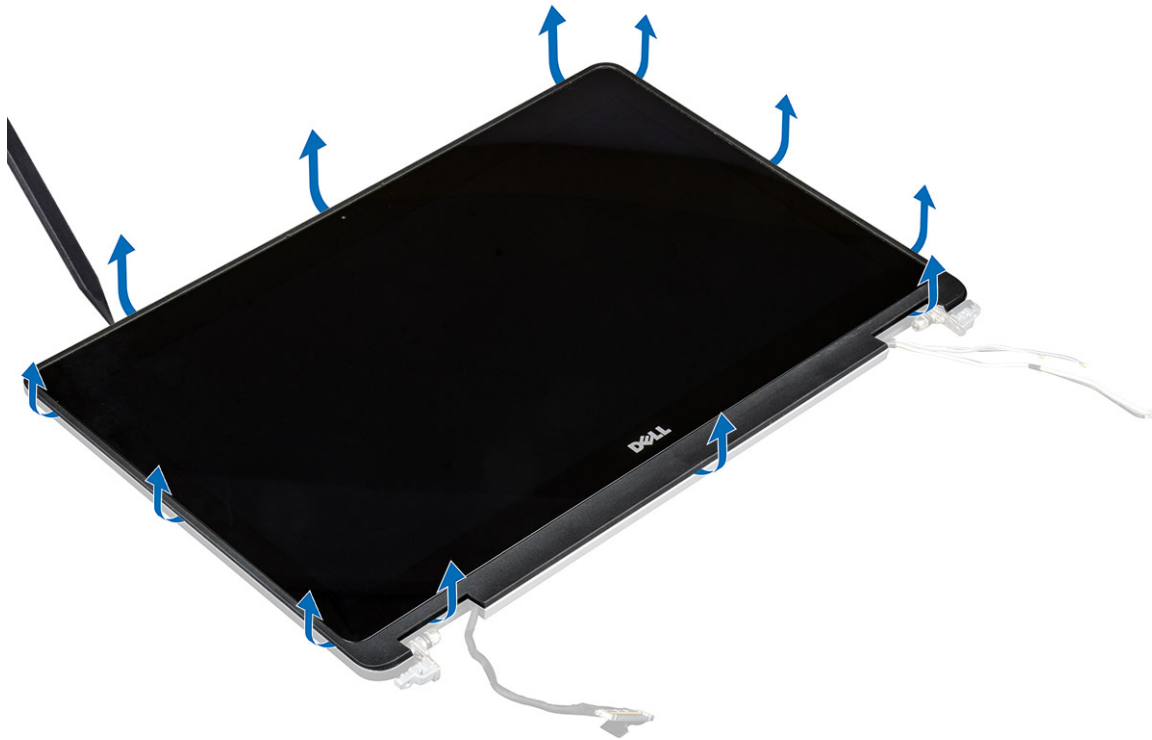

b) Lift the display panel and turn the display panel over to access the eDP and display cables.



c) Peel the adhesive tape to access the eDP cable [1, 5].

d) Disconnect the eDP and display cables from the connector on the back of the display panel [2, 3, 4, 6].



Installing the display panel

NOTE: For touch systems perform following steps.

1. To install the display panel for touch systems:
 - a) Place the display panel on a flat surface.
 - b) Connect the eDP and display cables to the connector on the back of the display panel and affix the adhesive tape.
 - c) Turn the display assembly over.
 - d) Align the display panel with the tabs on the display assembly.
 - e) Press the edges of the display panel to secure it to the display assembly.
2. Install the:
 - a) [display bezel](#)
 - b) [display assembly](#)
 - c) [palmrest](#)
 - d) [keyboard](#)
 - e) [hard drive](#)
 - f) [base cover](#)
 - g) [battery](#)
 - h) [battery cover](#)
3. Follow the procedure in [After working inside your computer](#).

Display bracket

Removing the display bracket

1. Follow the procedure in [Before working inside your computer](#).
2. Remove the:
 - a) [battery cover](#)
 - b) [battery](#)
 - c) [base cover](#)
 - d) [hard drive](#)
 - e) [keyboard](#)
 - f) [palmrest](#)
 - g) [display assembly](#)
 - h) [display bezel](#)
 - i) [display panel](#)
3. To remove display bracket:
 - a) Remove the M2.5x4.0 screws that secure display cover [1].
 - b) Remove the display brackets from the display cover [2].



Installing the display bracket

1. Place the display brackets in its slot on the display cover.
2. Replace the M2.5x4.0 screws to secure the display bracket..
3. Install the:
 - a) [display panel](#)
 - b) [display bezel](#)
 - c) [display assembly](#)
 - d) [palmrest](#)

- e) keyboard
- f) hard drive
- g) base cover
- h) battery
- i) battery cover

4. Follow the procedure in [After working inside your computer](#).

Display hinges

Removing the display hinge

1. Follow the procedure in [Before working inside your computer](#).

2. Remove the:

- a) battery cover
- b) battery
- c) base cover
- d) hard drive
- e) keyboard
- f) palmrest
- g) display assembly
- h) display bezel
- i) display panel

3. To remove display hinge:

- a) Remove the M2.5x4.0 screws that secure display hinges [1].
- b) Remove the display hinges from the display cover [2].

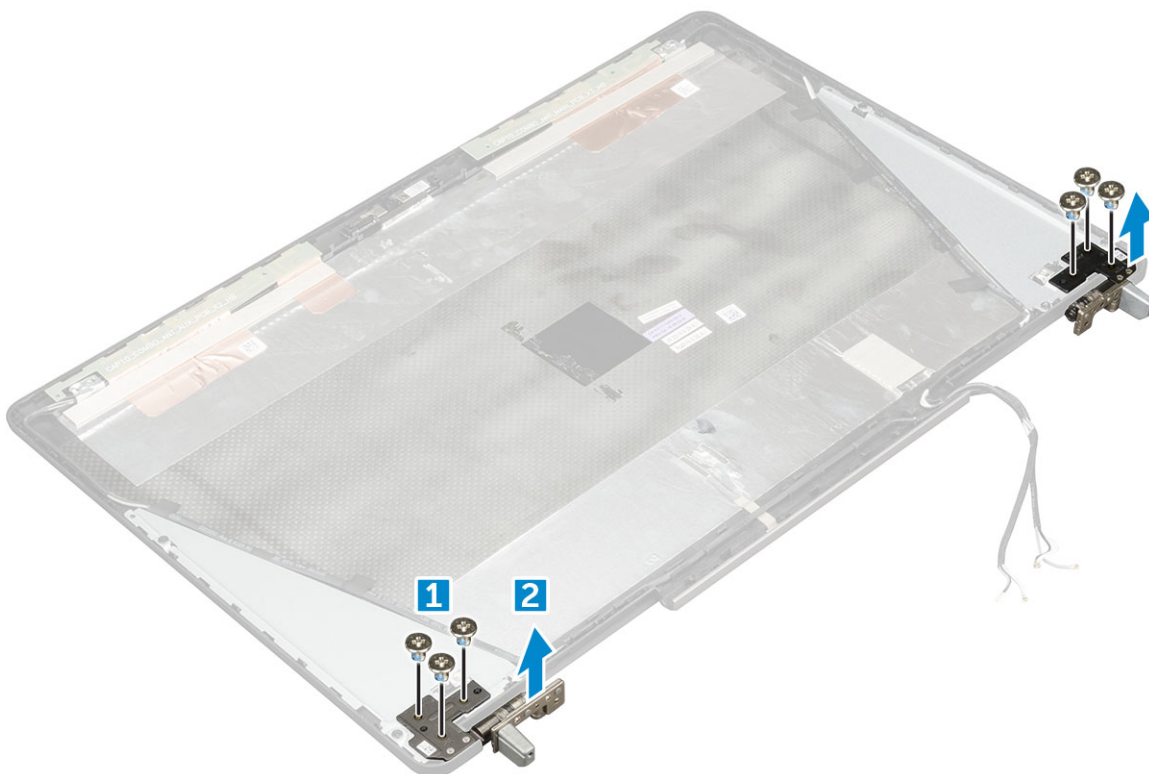

Installing the display hinge

1. Place the display hinge in its slot on the display cover.

2. Replace the M2.5x4.0 screws to secure the display hinge.
3. Install the:
 - a) display panel
 - b) display bezel
 - c) display assembly
 - d) palmrest
 - e) keyboard
 - f) hard drive
 - g) base cover
 - h) battery
 - i) battery cover
4. Follow the procedure in [After working inside your computer](#).

Display cover

Replacing the display cover

1. Follow the procedure in [Before working inside your computer](#).
2. Remove the:
 - a) battery cover
 - b) battery
 - c) base cover
 - d) hard drive
 - e) keyboard
 - f) palmrest
 - g) display assembly
 - h) display bezel
 - i) display panel
 - j) display bracket
 - k) display hinge
 - l) camera
 - m) eDP cable

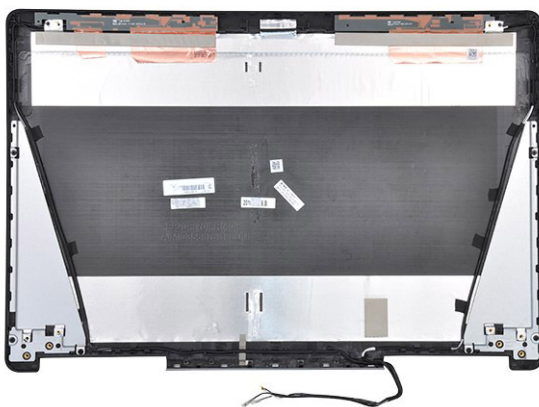

The component you are left with is the display cover.

3. Install:
 - a) eDP cable
 - b) camera
 - c) display hinge
 - d) display bracket
 - e) display panel

- f) display bezel
- g) display assembly
- h) palmrest
- i) keyboard
- j) hard drive
- k) base cover
- l) battery
- m) battery cover

4. Follow the procedure in [After working inside your computer](#).

eDP cable

Removing the eDP cable

1. Follow the procedure in [Before working inside your computer](#).
2. Remove the:
 - a) battery cover
 - b) battery
 - c) base cover
 - d) hard drive
 - e) keyboard
 - f) palmrest
 - g) display assembly
 - h) display bezel
 - i) display panel
3. To remove eDP cable:
 - a) Peel the eDP cable [1].
 - b) Unroute the eDP cable from the display cover [2, 3].

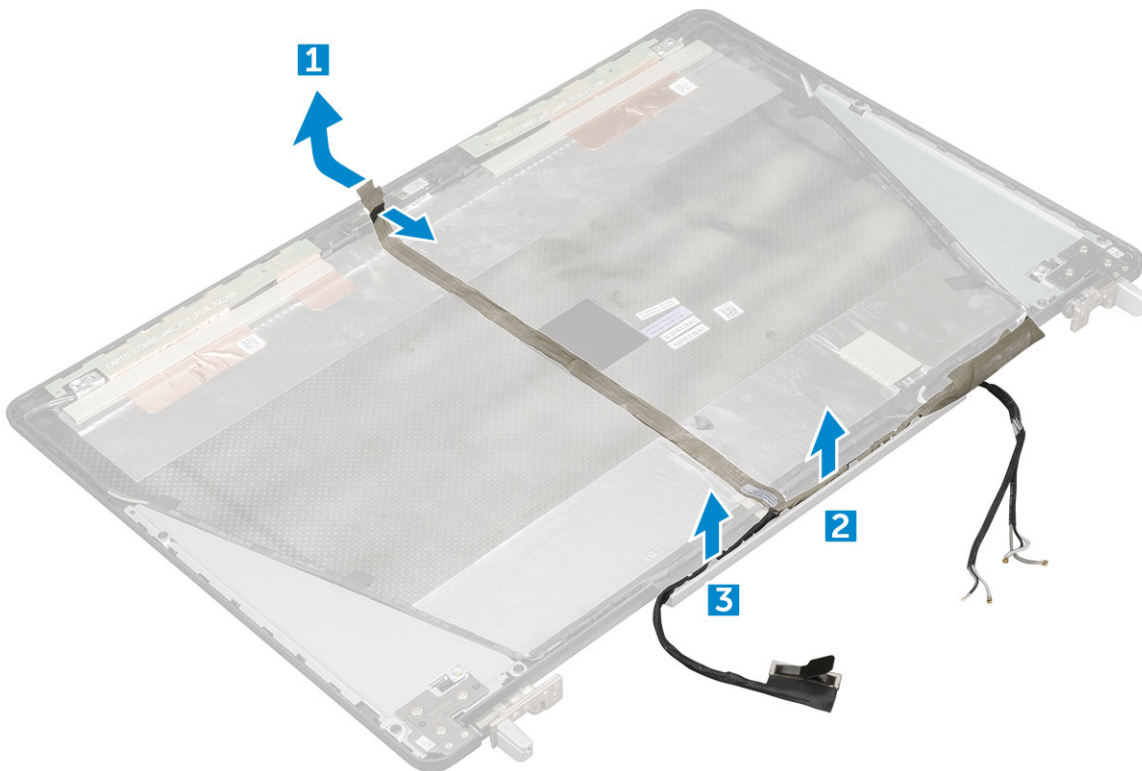

Installing the eDP cable

1. Route the eDP cable on the display cover.
2. Affix the eDP cable on the display cover.
3. Install the:
 - a) [display panel](#)
 - b) [display bezel](#)
 - c) [display assembly](#)
 - d) [palmrest](#)
 - e) [keyboard](#)
 - f) [hard drive](#)
 - g) [base cover](#)
 - h) [battery](#)
 - i) [battery cover](#)
4. Follow the procedure in [After working inside your computer](#).

Camera

Removing the camera

1. Follow the procedure in [Before working inside your computer](#).
2. Remove the:
 - a) [battery cover](#)
 - b) [battery](#)
 - c) [base cover](#)
 - d) [hard drive](#)
 - e) [keyboard](#)
 - f) [palmrest](#)
 - g) [display assembly](#)
 - h) [display bezel](#)
3. To remove camera:
 - a) Peel the eDP cable and disconnect the camera cable from the computer [1].
 - b) Lift the camera module from the computer [2].

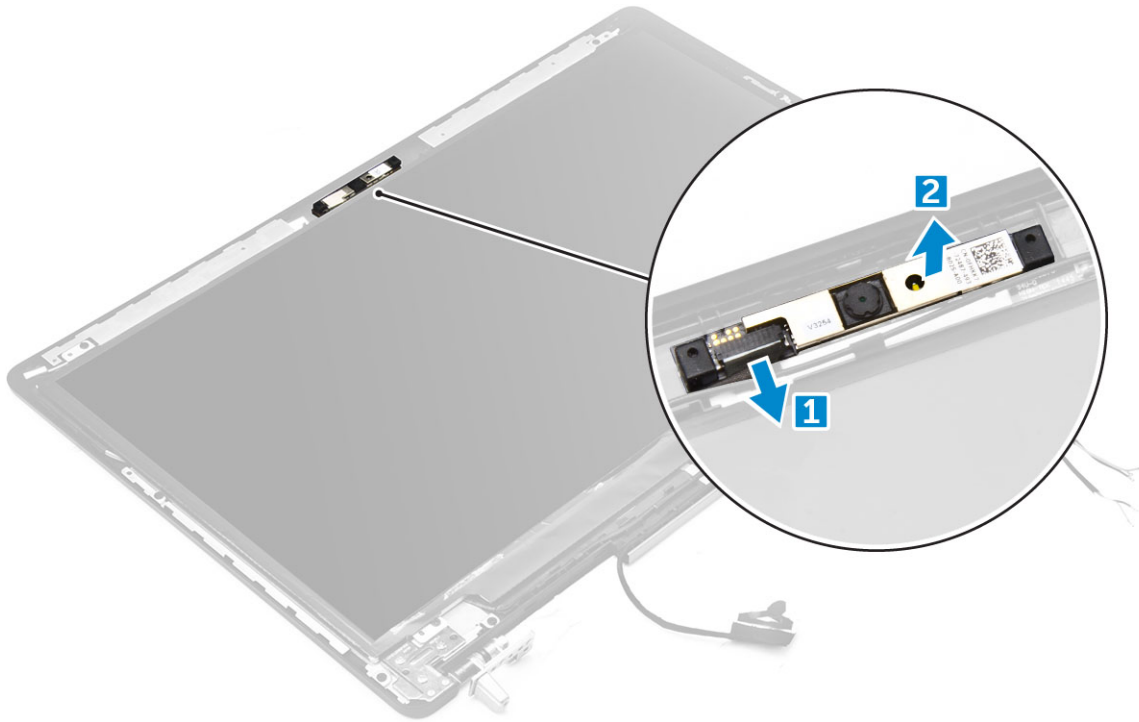

Installing the camera

1. Place the camera module in its slot on the computer.
2. Connect the camera cable.
3. Affix the eDP cable.
4. Install the:
 - a) display bezel
 - b) display assembly
 - c) palmrest
 - d) keyboard
 - e) hard drive
 - f) base cover
 - g) battery
 - h) battery cover
5. Follow the procedure in [After working inside your computer](#).

Technology and components

This chapter details the technology and components available in the system.

Topics:

- [Power adapter](#)
- [Processors](#)
- [USB features](#)
- [HDMI 1.4](#)

Power adapter

This laptop is shipped with 240 W power adapters.

⚠ WARNING: When you disconnect the power adapter cable from the laptop, grasp the connector, not the cable itself, and then pull firmly but gently to avoid damaging the cable.

⚠ WARNING: The power adapter works with electrical outlets worldwide. However, power connectors and power strips vary among countries. Using an incompatible cable or improperly connecting the cable to the power strip or electrical outlet may cause fire or equipment damage.

Processors

Latitude 7720 is shipped with any of the following processors:

7th generation processors (KabyLake)

- Intel Core Xeon E3-1535M v6 (Quad Core Xeon 3.10GHz, 4.20GHz Turbo, 8MB 45W)
- Intel Core Xeon E3-1505M v6 (Quad Core Xeon 3.00GHz, 4.00GHz Turbo, 8MB 45W)
- Intel Core i7-7920HQ (Quad Core 3.10GHz, 4.10GHz Turbo, 8MB 45W)
- Intel Core i7-7820HQ (Quad Core 2.90GHz, 3.90GHz Turbo, 8MB 45W)
- Intel Core i7-7700HQ (Quad Core 2.80GHz, 3.80GHz Turbo, 6MB 45W)- non vPro
- Intel Core i5-7440HQ (Quad Core 2.80GHz, 3.80GHz Turbo, 6MB 45W)
- Intel Core i5-7300HQ (Quad Core 2.50GHz, 3.50GHz Turbo, 6MB 45W)

6th generation processors (SkyLake)

- Intel Core Xeon E3-1575M v5 (Quad Core Xeon 3.00GHz, 3.90GHz Turbo, 8MB 45W)
- Intel Core Xeon E3-1545M v5 (Quad Core Xeon 2.90GHz, 3.80GHz Turbo, 8MB 45W)
- Intel Core i7-6920HQ (Quad Core 2.90GHz, 3.80GHz Turbo, 8MB 45W)
- Intel Core i7-6820HQ (Quad Core 2.70GHz, 3.60GHz Turbo, 8MB 45W)

i NOTE: The clock speed and performance varies depending on the workload and other variables.

Kaby Lake — 7th Generation Intel Core processors

The 7th Gen Intel Core processor (Kaby Lake) family is the successor of 6th generation processors (Skylake). It's main features include:

- Intel 14nm Manufacturing Process Technology
- Intel Turbo Boost Technology
- Intel Hyper Threading Technology
- Intel Built-in Visuals
 - Intel HD graphics - exceptional videos, editing smallest details in the videos
 - Intel Quick Sync Video - excellent video conferencing capability, quick video editing and authoring

- Intel Clear Video HD - visual quality and color fidelity enhancements for HD playback and immersing web browsing
- Integrated memory controller
- Intel Smart Cache
- Optional Intel vPro technology (on i5/i7) with Active Management Technology 11.6
- Intel Rapid Storage Technology

NOTE: Windows 7 and 8 are not supported by systems with 7th generation processors

USB features

Universal Serial Bus, or USB, was introduced in 1996. It dramatically simplified the connection between host computers and peripheral devices like mice, keyboards, external drives, and printers.

Let's take a quick look on the USB evolution referencing to the table below.

Table 1. USB evolution

Type	Data Transfer Rate	Category	Introduction Year
USB 2.0	480 Mbps	High Speed	2000
USB 3.0/USB 3.1 Gen 1	5 Gbps	Super Speed	2010
USB 3.1 Gen 2	10 Gbps	Super Speed	2013

USB 3.0/USB 3.1 Gen 1 (SuperSpeed USB)

For years, the USB 2.0 has been firmly entrenched as the de facto interface standard in the PC world with about 6 billion devices sold, and yet the need for more speed grows by ever faster computing hardware and ever greater bandwidth demands. The USB 3.0/USB 3.1 Gen 1 finally has the answer to the consumers' demands with a theoretically 10 times faster than its predecessor. In a nutshell, USB 3.1 Gen 1 features are as follows:

- Higher transfer rates (up to 5 Gbps)
- Increased maximum bus power and increased device current draw to better accommodate power-hungry devices
- New power management features
- Full-duplex data transfers and support for new transfer types
- Backward USB 2.0 compatibility
- New connectors and cable

The topics below cover some of the most commonly asked questions regarding USB 3.0/USB 3.1 Gen 1.



Speed

Currently, there are 3 speed modes defined by the latest USB 3.0/USB 3.1 Gen 1 specification. They are Super-Speed, Hi-Speed and Full-Speed. The new SuperSpeed mode has a transfer rate of 4.8Gbps. While the specification retains Hi-Speed, and Full-Speed USB mode, commonly known as USB 2.0 and 1.1 respectively, the slower modes still operate at 480Mbps and 12Mbps respectively and are kept to maintain backward compatibility.

USB 3.0/USB 3.1 Gen 1 achieves the much higher performance by the technical changes below:

- An additional physical bus that is added in parallel with the existing USB 2.0 bus (refer to the picture below).
- USB 2.0 previously had four wires (power, ground, and a pair for differential data); USB 3.0/USB 3.1 Gen 1 adds four more for two pairs of differential signals (receive and transmit) for a combined total of eight connections in the connectors and cabling.
- USB 3.0/USB 3.1 Gen 1 utilizes the bidirectional data interface, rather than USB 2.0's half-duplex arrangement. This gives a 10-fold increase in theoretical bandwidth.

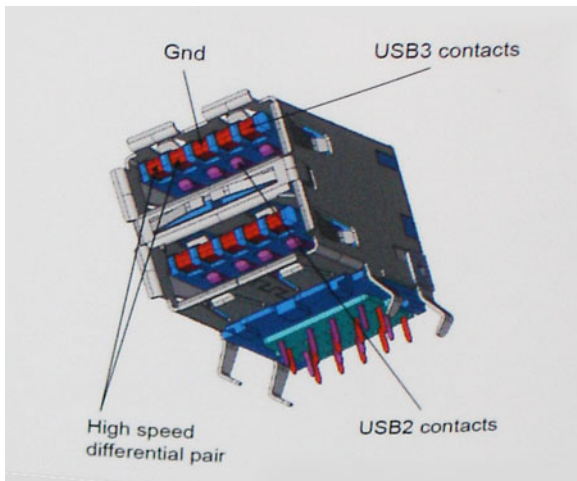

With today's ever increasing demands placed on data transfers with high-definition video content, terabyte storage devices, high megapixel count digital cameras etc., USB 2.0 may not be fast enough. Furthermore, no USB 2.0 connection could ever come close to the 480Mbps theoretical maximum throughput, making data transfer at around 320Mbps (40MB/s) — the actual real-world maximum. Similarly, USB 3.0/USB 3.1 Gen 1 connections will never achieve 4.8Gbps. We will likely see a real-world maximum rate of 400MB/s with overheads. At this speed, USB 3.0/USB 3.1 Gen 1 is a 10x improvement over USB 2.0.

Applications

USB 3.0/USB 3.1 Gen 1 opens up the laneways and provides more headroom for devices to deliver a better overall experience. Where USB video was barely tolerable previously (both from a maximum resolution, latency, and video compression perspective), it's easy to imagine that with 5-10 times the bandwidth available, USB video solutions should work that much better. Single-link DVI requires almost 2Gbps throughput. Where 480Mbps was limiting, 5Gbps is more than promising. With its promised 4.8Gbps speed, the standard will find its way into some products that previously weren't USB territory, like external RAID storage systems.

Listed below are some of the available SuperSpeed USB 3.0/USB 3.1 Gen 1 products:

- External Desktop USB 3.0/USB 3.1 Gen 1 Hard Drives
- Portable USB 3.0/USB 3.1 Gen 1 Hard Drives
- USB 3.0/USB 3.1 Gen 1 Drive Docks & Adapters
- USB 3.0/USB 3.1 Gen 1 Flash Drives & Readers
- USB 3.0/USB 3.1 Gen 1 Solid-state Drives
- USB 3.0/USB 3.1 Gen 1 RAIDs
- Optical Media Drives
- Multimedia Devices
- Networking
- USB 3.0/USB 3.1 Gen 1 Adapter Cards & Hubs

Compatibility

The good news is that USB 3.0/USB 3.1 Gen 1 has been carefully planned from the start to peacefully co-exist with USB 2.0. First of all, while USB 3.0/USB 3.1 Gen 1 specifies new physical connections and thus new cables to take advantage of the higher speed capability of the new protocol, the connector itself remains the same rectangular shape with the four USB 2.0 contacts in the exact same location as before. Five new connections to carry receive and transmitted data independently are present on USB 3.0/USB 3.1 Gen 1 cables and only come into contact when connected to a proper SuperSpeed USB connection.

HDMI 1.4

This topic explains the HDMI 1.4 and its features along with the advantages.

HDMI (High-Definition Multimedia Interface) is an industry-supported, uncompressed, all-digital audio/video interface. HDMI provides an interface between any compatible digital audio/video source, such as a DVD player, or A/V receiver and a compatible digital audio and/or video monitor, such as a digital TV (DTV). The intended applications for HDMI TVs, and DVD players. The primary advantage is cable reduction and content protection provisions. HDMI supports standard, enhanced, or high-definition video, plus multichannel digital audio on a single cable.

 **NOTE: The HDMI 1.4 will provide 5.1 channel audio support.**

HDMI 1.4 Features

- **HDMI Ethernet Channel** - Adds high-speed networking to an HDMI link, allowing users to take full advantage of their IP-enabled devices without a separate Ethernet cable
- **Audio Return Channel** - Allows an HDMI-connected TV with a built-in tuner to send audio data "upstream" to a surround audio system, eliminating the need for a separate audio cable
- **3D** - Defines input/output protocols for major 3D video formats, paving the way for true 3D gaming and 3D home theater applications
- **Content Type** - Real-time signaling of content types between display and source devices, enabling a TV to optimize picture settings based on content type
- **Additional Color Spaces** - Adds support for additional color models used in digital photography and computer graphics
- **4K Support** - Enables video resolutions far beyond 1080p, supporting next-generation displays that will rival the Digital Cinema systems used in many commercial movie theaters
- **HDMI Micro Connector** - A new, smaller connector for phones and other portable devices, supporting video resolutions up to 1080p
- **Automotive Connection System** - New cables and connectors for automotive video systems, designed to meet the unique demands of the motoring environment while delivering true HD quality

Advantages of HDMI

- Quality HDMI transfers uncompressed digital audio and video for the highest, crispest image quality.
- Low -cost HDMI provides the quality and functionality of a digital interface while also supporting uncompressed video formats in a simple, cost-effective manner
- Audio HDMI supports multiple audio formats from standard stereo to multichannel surround sound
- HDMI combines video and multichannel audio into a single cable, eliminating the cost, complexity, and confusion of multiple cables currently used in A/V systems
- HDMI supports communication between the video source (such as a DVD player) and the DTV, enabling new functionality

System specifications

NOTE: Offerings may vary by region. The following specifications are only those required by law to ship with your computer. For more information about the configuration of your computer, go to Help and Support in your Windows operating system and select the option to view information about your computer.

Topics:

- [System information](#)
- [Processor](#)
- [Memory](#)
- [Graphics](#)
- [Audio](#)
- [Communication](#)
- [Expansion bus](#)
- [Ports and connectors](#)
- [Display](#)
- [Keyboard](#)
- [Touchpad](#)
- [Camera](#)
- [Storage](#)
- [Battery](#)
- [AC adapter](#)
- [Contactless smart card](#)
- [Physical dimension](#)
- [Environmental](#)

System information

Feature	Specification
System Chipset	Intel CM238 Chipset
Interrupt Levels	Interrupt Controller <ul style="list-style-type: none"> • Supports up to eight legacy interrupt pins • Supports PCI 2.3 Message Signaled Interrupts <ul style="list-style-type: none"> • Integrated IO APIC capability with 24 interrupts • Supports Processor System Bus interrupt delivery
BIOS Chip (NVRAM)	64Mbit (8MB) & 32Mbit (4MB)

Processor

Feature	Specification
Processor type	<ul style="list-style-type: none"> • 6th generation Intel i7, Xeon processors (SkyLake) • 7th generation Intel Core i5, i7 and Xeon processors (KabyLake)
L1 cache	Up to 32 KB cache depending on processor type

L2 cache	Up to 256 KB cache depending on processor type
L3 cache	Up to 8 MB cache depending on processor type
Intel Smart cache with Last Level Cache	Up to 8 MB cache depending on processor type

Memory

Feature	Specification
Type	DDR4 SDRAM
Speed	<ul style="list-style-type: none"> 2400 MHz
Connectors	4
Capacity	8GB, 16 GB
Minimum Memory	8 GB (1 x 8 GB)
Maximum memory	64 GB

Feature	Specification
Type	DDR4 SDRAM
Speed	<ul style="list-style-type: none"> 2667 MHz (Non-ECC only)
Connectors	4
Capacity	8GB, 16 GB
Minimum Memory	8 GB (1 x 8 GB)
Maximum memory	32 GB

Graphics

Feature	Specification
Type	MXM type-B add-in card
Data bus	PCIe x16, Gen3
Video controller and memory:	<ul style="list-style-type: none"> Radeon Pro WX 4130 w/2GB GDDR5 NVIDIA Quadro M1200 w/4GB GDDR5 NVIDIA Quadro P3000 w/6GB GDDR5 Radeon Pro WX 7100 w/8GB GDDR5 NVIDIA Quadro P4000 w/8GB GDDR5 NVIDIA Quadro P5000 w/16GB GDDR5

Audio

Features	Specification
Integrated	dual-channel High-Definition audio

Communication

Feature	Specification
----------------	---------------

Ethernet adapter	network interface card capable of 10/100/1000 mb/s communication
Wireless	<p>WLAN options:</p> <ul style="list-style-type: none"> Intel WiFi Link 8265 2x2 802.11ac+BT 4.2 (vPro) Intel WiFi Link 8265 2x2 802.11ac NBT (vPro) Dell DW 1820 2x2 802.11ac+BT 4.2 US <p>Optional Mobile broadband and GPS</p> <ul style="list-style-type: none"> DW5811e (Gobi 4G/LTE - FMC)

Expansion bus

Feature	Specification
Bus Type	PCI Express 1.0, 2.0 and 3.0, SATA 1.0A, 2.0 and 3.0, USB 2.0 and 3.0
Bus Width	PCIe X16
BIOS Chip (NVRAM)	128 Mb (16 MB)

Ports and connectors

Feature	Specification
Audio	Universal audio jack connector
Network Adapter	one RJ45 connector
USB C connector with Thunderbolt	one (optional)
USB 3.1 with Gen 1 (with PowerShare)	four
Video	HDMI 1.4, mDP 1.4
Memory card reader	SD 4.0
Docking port	one
E-dock connector	one
Micro Subscriber Identity Module (Micro SIM) port	one
Smart card (optional)	one

Display

Features	Specification
Type	<ul style="list-style-type: none"> FHD (1920 x 1080) UHD (3840 x 2160) HD+ TN (1600x900)
Size	17.3 inches
Height	214.92 mm (8.42 inches)

Width	382.08 mm (15.04 inches)
Diagonal	438.38 mm (17.25 inches)
Active area (X/Y)	<ul style="list-style-type: none"> • FHD (1920 x 1080) • UHD (3840 x 2160) • HD+ TN (1600x900)
Maximum resolution	<ul style="list-style-type: none"> • FHD (1920 x 1080) • UHD (3840 x 2160) • HD+ TN (1600x900)
Maximum Brightness	<ul style="list-style-type: none"> • FHD (300 nits) • UHD (400 nits) • HD+ TN (220 nits)
Operating angle	0° (closed) to 135°
Refresh rate	60 Hz
Minimum viewing angles:	
Horizontal/\	<ul style="list-style-type: none"> • FHD (40/80) • UHD (80) • HD+ TN (40/40 degrees)
Vertical	<ul style="list-style-type: none"> • FHD (10/80) • UHD (80) • HD+ TN (10/30 degrees)

Keyboard

Features	Specification
Number of keys	<ul style="list-style-type: none"> • United States: 103 keys • United Kingdom: 104 keys • Brazil: 106 keys • Japan: 107 keys
Layout	QWERTY/AZERTY/Kanji

Touchpad

Features	Specification
X/Y position resolution	<ul style="list-style-type: none"> • X: 41.27+-4.13 counts/mm • Y: 38.75+-3.88 counts/mm • 1048/984 cpi
Size	Sensor-active area: <ul style="list-style-type: none"> • Width: 99.5mm (3.92 inches) • Height: 53mm (2.09 inches)
Multi-Touch	Configurable single finger and multi-finger gestures

Camera

Features	Specification
Type	CMOS Sensor
Still Resolution	1280 x 720 Pixels (Maximum)
Video Resolution	1280 x 720 Pixels (Maximum)
Diagonal	74 degrees

Storage

Features	Specification
Storage:	<ul style="list-style-type: none">• 500GB 2.5" 7mm SATA (7200 RPM) Hard Drive• 1TB 2.5" 7mm SATA (7200 RPM) Hard Drive• 2TB 2.5" 7mm SATA (5400 RPM) Hard Drive• 256GB 2.5" 7mm SATA Solid State Drive Class 20• 360GB 2.5" 7mm SATA Solid State Drive Class 20• 512GB 2.5" 7mm SATA Solid State Drive Class 20• 512GB 2.5" 7mm SATA SED Solid State Drive Class 20• 1TB 2.5" 7mm SATA Solid State Drive Class 20• M.2 PCIe 256GB SSD Class 40• M.2 PCIe 512GB SSD Class 40• M.2 PCIe 512GB SED SSD Class 40• M.2 PCIe 1TB SSD Class 40• M.2 PCIe 2TB SSD Class 40• M.2 PCIe 512GB SSD Class 50• M.2 PCIe 1TB SSD Class 50• M.2 PCIe 2TB SSD Class 50
Size	1 TB 5400 rpm, 128/256/512 GB SATA 3 SSD, 256 GB SATA 3 SSD, 1 TB M.2 SSD, 1 TB SATA 3 SSD

Battery

Features	Specification
Wattage	91Whr
Type	lithium ion
Dimensions (6-cell entry/ 6-cell upsell/ 6-cell long cycle life (LCL)):	1280 x 720 Pixels (Maximum)
Length	243.89 mm (9.6 inches)
Height	18.45 mm (0.73inches)
Width	71.30 mm (2.81inches)
Weight	18.45 mm (0.73inches")
Voltage	400.00 g (0.88 lb)
Life span	<ul style="list-style-type: none">• 300 discharge/charge cycles• 1000 discharge/charge cycles (LCL)
Operating	<ul style="list-style-type: none">• Charge: 0°C to 50°C (32°F to 158°F)

- Discharge: 0°C to 70°C (32°F to 122°F)

Non-Operating -20°C to 65°C (4°F to 149°F)

Coin-cell battery 3 V CR2032 lithium ion cell

AC adppter

Features	Specification
Input voltage	100 VAC to 240 VAC
Input current (maximum)	3.50 A
Input frequency	50 Hz to 60 Hz
Output power	240 W
Output current	12.31 A
Rated output voltage	19.50 VDC
Dimensions:	240 W
Height	25.40 mm (1 inch)
Width	200 mm (7.87 inches)
Depth	100 mm (3.94 inches)
Weight	0.85 kg (1.88 lb)
Temperature range:	
Operating	0°C to 40°C (32°F to 104°F)
Non-Operating	-40°C to 70°C (-40°F to 158°F)

Contactless smart card

Features	Specification
Supported Smart Cards and technologies	<ul style="list-style-type: none"> · ISO14443A — 160 kbps, 212 kbps, 424 kbps, and 848 kbps · ISO14443B — 160 kbps, 212 kbps, 424 kbps, and 848 kbps · ISO15693 · HID iClass · FIPS201 · NXP Desfire

Physical dimension

Feature	Specification
Weight (pounds/ kilograms)	7.5 lbs (3.40 kgs)
Dimensions	
Height (inches/mm)	
Front (non-touch)	1.13 inches (28.7mm)

Rear (non-touch)	1.39 inches (35.3mm)
Width (inches/mm)	16.41 inches (416.7mm)
Depth (inches/mm)	11.07 inches (281.2 mm)

Environmental

Feature	Specification
Temperature range:	
Operating	0°C to 40°C (32°F to 104°F)
Storage	-40°C to 65 °C (-40°F to 149°F)
Relative humidity (maximum):	
Operating	10 % to 90 % (non-condensing)
Storage	5 % to 95 % (non-condensing)
Maximum vibration:	
Operating	0.66 GRMS, 2 Hz — 600 Hz
Storage	0.66 GRMS, 2 Hz — 600 Hz
Maximum shock:	
Operating	140 G, 2 MS
Storage	163 G, 2 MS
Altitude:	
Storage	0 -m to 10,668 -m (0 ft to 35,000 ft)
Airborne contaminant level	G1 or lower as defined by ANSI/ISA-S71.04-1985

System setup

System setup enables you to manage your notebook hardware and specify BIOS level options. From the System setup, you can:

- Change the NVRAM settings after you add or remove hardware
- View the system hardware configuration
- Enable or disable integrated devices
- Set performance and power management thresholds
- Manage your computer security

Topics:

- [Boot menu](#)
- [Navigation keys](#)
- [System setup options](#)
- [Virtualization support screen options](#)
- [Wireless screen options](#)
- [Maintenance screen options](#)
- [System Log screen options](#)
- [Updating the BIOS in Windows](#)
- [System and setup password](#)

Boot menu

Press <F12> when the Dell logo appears to initiate a one-time boot menu with a list of the valid boot devices for the system. Diagnostics and BIOS Setup options are also included in this menu. The devices listed on the boot menu depend on the bootable devices in the system. This menu is useful when you are attempting to boot to a particular device or to bring up the diagnostics for the system. Using the boot menu does not make any changes to the boot order stored in the BIOS.

The options are:

- UEFI Boot:
 - Windows Boot Manager
- Other Options:
 - BIOS Setup
 - BIOS Flash Update
 - Diagnostics
 - Change Boot Mode Settings

Navigation keys

 **NOTE:** For most of the System Setup options, changes that you make are recorded but do not take effect until you restart the system.

Keys	Navigation
Up arrow	Moves to the previous field.
Down arrow	Moves to the next field.
Enter	Selects a value in the selected field (if applicable) or follow the link in the field.
Spacebar	Expands or collapses a drop-down list, if applicable.

Keys	Navigation
Tab	Moves to the next focus area.
Esc	Moves to the previous page until you view the main screen. Pressing Esc in the main screen displays a message that prompts you to save any unsaved changes and restarts the system.

System setup options

 **NOTE:** Depending on the laptop and its installed devices, the items listed in this section may or may not appear.

General screen options

This section lists the primary hardware features of your computer.

Option	Description
System Information	<p>This section lists the primary hardware features of your computer.</p> <ul style="list-style-type: none"> System Information: Displays BIOS Version, Service Tag, Asset Tag, Ownership Tag, Ownership Date, Manufacture Date, and the Express Service Code. Memory Information: Displays Memory Installed, Memory Available, Memory Speed, Memory Channels Mode, Memory Technology, DIMM ASize, DIMM B Size, DIMM CSize, DIMM D Size, Processor Information: Displays Processor Type, Core Count, Processor ID, Current Clock Speed, Minimum Clock Speed, Maximum Clock Speed, Processor L2 Cache, Processor L3 Cache, HT Capable, and 64-Bit Technology. Device Information: Displays Primary Hard Drive, SATA-0, M.2 PCIe SSD-0, M.2 PCIe SSD-1, Dock eSATA Device, LOM MAC Address, Passthrough MAC address, Video Controller, dGPU video controller, Video BIOS Version, Video Memory, Panel Type, Native Resolution, Audio Controller, Wi-Fi Device, Cellular Device, Bluetooth Device.
Battery Information	Displays the battery status and the type of AC adapter connected to the computer.
Boot Sequence	<p>Allows you to change the order in which the computer attempts to find an operating system.</p> <ul style="list-style-type: none"> Windows Boot Manager Boot list options: <ul style="list-style-type: none"> Legacy <ul style="list-style-type: none"> Diskette Drive Internal HDD USB Storage Device CD/DVD/CD-RW Drive Onboard NIC UEFI (selected by default)
Advanced Boot Options	<p>This option allows you the legacy option ROMs to load. By default, the Enable Legacy Option ROMs is enabled.</p> <ul style="list-style-type: none"> Enable Attempt Legacy Boot
UEFI boot path security	<ul style="list-style-type: none"> Always, except internal HDD (selected by default) Always Never
Date/Time	Allows you to change the date and time.

System Configuration screen options

Option	Description
Integrated NIC	Allows you to configure the integrated network controller. The options are:

Option	Description
	<ul style="list-style-type: none"> · Enable UEFI Network Stack · Disabled · Enabled · Enabled w/PXE: This option is enabled by default.
Parallel Port	<p>Allows you to configure the parallel port on the docking station. The options are:</p> <ul style="list-style-type: none"> · Disabled · AT: This option is enabled by default. · PS2 · ECP
Serial Port	<p>Allows you to configure the integrated serial port. The options are:</p> <ul style="list-style-type: none"> · Disabled · COM1: This option is selected by default. · COM2 · COM3 · COM4
SATA Operation	<p>Allows you to configure the internal SATA hard-drive controller. The options are:</p> <ul style="list-style-type: none"> · Disabled · AHCI · RAID On: This option is enabled by default.
Drives	<p>Allows you to configure the SATA drives on board. All drives are enabled by default. The options are:</p> <ul style="list-style-type: none"> · SATA-0 · SATA-1 · SATA-4 · M.2 PCI-e SSD-0 · M.2 PCIe SSD-1 · SATA-3
SMART Reporting	<p>This field controls whether hard drive errors for integrated drives are reported during system startup. This technology is part of the SMART (Self Monitoring Analysis and Reporting Technology) specification. This option is disabled by default.</p> <ul style="list-style-type: none"> · Enable SMART Reporting
USB Configuration	<p>This is an optional feature.</p> <p>This field configures the integrated USB controller. If Boot Support is enabled, the system is allowed to boot any type of USB Mass Storage Devices (HDD, memory key, floppy).</p> <p>If USB port is enabled, device attached to this port is enabled and available for OS.</p> <p>If USB port is disabled, the OS cannot see any device attached to this port.</p> <p>The options are:</p> <ul style="list-style-type: none"> · Enable Boot support (by default enable) · Enable Thunderbolt ports (by default enable) · Always Allow dell docks · Enable external USB ports <p>Others:</p> <ul style="list-style-type: none"> · Enable Thubderbolt Boot Support · Enable Thunderbolt (and PCIE behind TBT) Pre-boot · Security level-no security · Security level-user configuration (selected by default) · Security level-secure connect · Security level- Display port only





Option	Description
	 NOTE: USB keyboard and mouse always work in the BIOS setup irrespective of these settings.
USB PowerShare	This field configures the USB PowerShare feature behavior. This option allows you to charge external devices using the stored system battery power through the USB PowerShare port (disabled by default)..
Audio	<p>This field enables or disables the integrated audio controller. By default, the Enable Audio option is selected. The options are:</p> <ul style="list-style-type: none"> • Enable Microphone (by default enable) • Enable Internal Speaker (by default enable)
Keyboard Illumination	<p>This field lets you choose the operating mode of the keyboard illumination feature. The keyboard brightness level can be set from 0% to 100%. The options are:</p> <ul style="list-style-type: none"> • Disabled (selected by default) • Dim • Bright
Keyboard Backlight with AC	The Keyboard Backlight with AC option does not affect the main keyboard illumination feature. Keyboard Illumination will continue to support the various illumination levels. This field has an effect when the backlight is enabled (selected by default).
Keyboard Backlight Timeout on AC	<p>The Keyboard Backlight Time-out dims out with AC option. The main keyboard illumination feature is not affected. Keyboard Illumination will continue to support the various illumination levels. This field has an effect when the backlight is enabled.</p> <ul style="list-style-type: none"> • 5 sec • 10 sec (selected by default) • 15 sec • 30 sec • 1 min • 5 min • 15 min • never
Keyboard Backlight Timeout on Battery	<p>The Keyboard Backlight Time-out dims out with Battery option. The main keyboard illumination feature is not affected. Keyboard Illumination will continue to support the various illumination levels. This field has an effect when the backlight is enabled.</p> <ul style="list-style-type: none"> • 5 sec • 10 sec (selected by default) • 15 sec • 30 sec • 1 min • 5 min • 15 min • never
Unobtrusive Mode	This option, when enabled, pressing Fn+F7 turns off all light and sound emissions in the system. To resume normal operation, press Fn+F7 again. This option is disabled by default.
Miscellaneous Devices	<p>Allows you to enable or disable the following devices:</p> <ul style="list-style-type: none"> • Enable Camera —enabled by default • Enable Expresscard (selected by default) • Enable HardDrive Free Fall Protection (selected by default) • WiFi Radio (selected by default) • Enable Secure Digital (SD) Card (selected by default) • Secure Digital (SD) Card Read-Only Mode • Secure Digital (SD) Card Boot

Video screen options

Option	Description
LCD Brightness	Allows you to set the display brightness depending upon the power source. On Battery(50% is default) and On AC (100 % default).
Switchable Graphics	<ul style="list-style-type: none">· Enable Switchable Graphics (selected by default)· Enable Dock Display Port(selected by default)· Graphics Spec Mode

 **NOTE:** The video setting will be visible only when a video card is installed into the system.

Security screen options

Option	Description
Admin Password	<p>Allows you to set, change, or delete the administrator (admin) password.</p> <p> NOTE: You must set the admin password before you set the system or hard drive password. Deleting the admin password automatically deletes the system password and the hard drive password.</p> <p> NOTE: Successful password changes take effect immediately.</p> <p>Default setting: Not set</p>
System Password	<p>Allows you to set, change or delete the system password.</p> <p> NOTE: Successful password changes take effect immediately.</p> <p>Default setting: Not set</p>
Internal HDD-2 Password	<p>Allows you to set, change, or delete the administrator password.</p> <p> NOTE: Successful password changes take effect immediately.</p> <p>Default setting: Not set</p>
Strong Password	<p>Allows you to enforce the option to always set strong passwords.</p> <p>Default Setting: Enable Strong Password is not selected.</p> <p> NOTE: If Strong Password is enabled, Admin and System passwords must contain at least one uppercase character, one lowercase character and be at least 8 characters long.</p>
Password Configuration	<p>Allows you to specify the minimum and max password lengths of Administrator and System passwords.</p> <ul style="list-style-type: none">· minimum -4(by default, if you want to change you can increase the number)· maximum -32 (you can decrease the number)
Password Bypass	<p>Allows you to enable or disable the permission to bypass the System and the Internal HDD password, when they are set. The options are:</p> <ul style="list-style-type: none">· Disabled· Reboot bypass <p>Default setting: Disabled</p>
Password Change	<p>Allows you to enable the disable permission to the System and Hard Drive passwords when the admin password is set.</p> <p>Default setting: Allow Non-Admin Password Changes is selected.</p>
Non-Admin Setup Changes	<p>Allows you to determine whether changes to the setup options are allowed when an Administrator Password is set. If disabled the setup options are locked by the admin password.</p> <ul style="list-style-type: none">· allow wireless switch changes

Option	Description
UEFI Capsule Firmware Updates	Allows you to enable or disable. This option controls whether this system allows BIOS updated via UEFI capsule update packages. The options are: <ul style="list-style-type: none"> · Enable UEFI Capsule Firmware—enabled by default
Computrace	Allows you to activate or disable the optional Computrace software. The options are: <ul style="list-style-type: none"> · Deactivate · Disable · Activate (selected by default) <p>NOTE: The Activate and Disable options will permanently activate or disable the feature and no further changes will be allowed</p>
CPU XD Support	Allows you to enable the Execute Disable mode of the processor. Enable CPU XD Support (default)
OROM Keyboard Access	Allows you to set an option to enter the Option ROM Configuration screens using hotkeys during boot. The options are: <ul style="list-style-type: none"> · Enable · One Time Enable · Disable Default setting: Enable
Admin Setup Lockout	Allows you to prevent users from entering Setup when an Administrator password is set. Default Setting: Disabled
Master password lockout	This option is not selected by default

Secure Boot screen options

Option	Description
Secure Boot Enable	This option enables or disables the Secure Boot feature. <ul style="list-style-type: none"> · Disabled · Enabled Default setting: Enabled.
Expert Key Management	Allows you to manipulate the security key databases only if the system is in Custom Mode. The Enable Custom Mode option is disabled by default. The options are: <ul style="list-style-type: none"> · PK—enabled by default · KEK · db · dbx <p>If you enable the Custom Mode, the relevant options for PK, KEK, db, and dbx appear. The options are:</p> <ul style="list-style-type: none"> · Save to File—Saves the key to a user-selected file · Replace from File—Replaces the current key with a key from a user-selected file · Append from File—Adds a key to the current database from a user-selected file · Delete—Deletes the selected key · Reset All Keys—Resets to default setting · Delete All Keys—Deletes all the keys <p>NOTE: If you disable the Custom Mode, all the changes made are erased and the keys restore to default settings.</p>

Intel Software Guard Extensions screen options

Option	Description
Intel SGX Enable	This field specifies you to provide a secured environment for running code/storing sensitive information in the context of the main OS. The options are: <ul style="list-style-type: none">• Disabled• Enabled• Software controlled (default)
Enclave Memory Size	This option sets SGX Enclave Reserve Memory Size . The options are: <ul style="list-style-type: none">• 32 MB• 64 MB• 128 MB (default)

Performance screen options

Option	Description
Multi Core Support	This field specifies whether the process has one or all cores enabled. The performance of some applications improves with the additional cores. This option is enabled by default. Allows you to enable or disable multi-core support for the processor. The installed processor supports two cores. If you enable Multi Core Support, two cores are enabled. If you disable Multi Core Support, one core is enabled. <ul style="list-style-type: none">• All (selected by default)• 1• 2• 3
Intel SpeedStep	Allows you to enable or disable the Intel SpeedStep feature. <ul style="list-style-type: none">• Enable Intel SpeedStep Default setting: The option is enabled.
C-States Control	Allows you to enable or disable the additional processor sleep states. <ul style="list-style-type: none">• C states Default setting: The option is enabled.
Intel TurboBoost	Allows you to enable or disable the Intel TurboBoost mode of the processor. <ul style="list-style-type: none">• Enable Intel TurboBoost Default setting: The option is enabled.
Hyper-Thread Control	Allows you to enable or disable the Hyper-Threading in the processor. <ul style="list-style-type: none">• Disabled• Enabled Default setting: Enabled.

Power Management screen options

Option	Description
AC Behavior	Allows you to enable or disable the computer from turning on automatically when an AC adapter is connected. Default setting: Wake on AC is not selected.
Auto On Time	Allows you to set the time at which the computer must turn on automatically. The options are:

Option	Description
Deep Sleep Control	<ul style="list-style-type: none"> • Disabled • Every Day • Weekdays • Select Days <p>Default setting: Disabled</p> <ul style="list-style-type: none"> • Disabled (selected by default) • Enabled in S5 only • Enabled in S4 and S5
USB Wake Support	<p>Allows you to enable USB devices to wake the system from Standby.</p> <p>i NOTE: This feature is only functional when the AC power adapter is connected. If the AC power adapter is removed during Standby, the system setup removes power from all the USB ports to conserve battery power.</p> <ul style="list-style-type: none"> • Enable USB Wake Support • Wake on Dell USB-C dock
Wireless Radio Control	<p>Allows you to enable or disable the feature that automatically switches from wired or wireless networks without depending on the physical connection.</p> <ul style="list-style-type: none"> • Control WLAN Radio • Control WWAN Radio
Wake on LAN/WLAN	<p>Allows you to enable or disable the feature that powers on the computer from the Off state when triggered by a LAN signal.</p> <ul style="list-style-type: none"> • Disabled • LAN Only • WLAN Only • LAN or WLAN <p>Default setting: Disabled</p>
Peak Shift	<p>This option enables you to minimize the AC power consumption during the peak power times of day. After you enable this option, your system runs only in battery even if the AC is attached.</p> <ul style="list-style-type: none"> • Enable peak shift (disabled) • Set battery threshold
Advanced Battery Charge Configuration	<p>This option enables you to maximize the battery health. By enabling this option, your system uses the standard charging algorithm and other techniques, during the non-work hours to improve the battery health.</p>
Primary Battery Charge Configuration	<p>Allows you to select the charging mode for the battery. The options are:</p> <ul style="list-style-type: none"> • Adaptive (default) • Standard — Fully charges your battery at a standard rate. • ExpressCharge — The battery charges over a shorter period of time using Dell’s fast charging technology. This option is enabled by default. • Primarily AC use • Custom <p>If Custom Charge is selected, you can also configure Custom Charge Start and Custom Charge Stop.</p> <p>i NOTE: All charging mode may not be available for all the batteries. To enable this option, disable the Advanced Battery Charge Configuration option.</p>
Type-C connector power	<ul style="list-style-type: none"> • 7.5 Watts(selected by default) • 15 Watts

POST Behavior screen options

Option	Description
Adapter Warnings	Allows you to enable or disable the system setup (BIOS) warning messages when you use certain power adapters. Default setting: Enable Adapter Warnings
Keypad (Embedded)	Allows you to choose one of two methods to enable the keypad that is embedded in the internal keyboard. <ul style="list-style-type: none">· Fn Key Only: This option is enabled by default.· By Numlock <p> NOTE: When setup is running, this option has no effect. Setup works in Fn Key Only mode.</p>
Mouse/Touchpad	Allows you to define how the system handles mouse and touch pad input. The options are: <ul style="list-style-type: none">· Serial Mouse· PS2 Mouse· Touchpad/PS-2 Mouse: This option is enabled by default.
Numlock Enable	Allows you to enable the Numlock option when the computer boots. Enable Numlock. This option is enabled by default.
Fn Key Emulation	Allows you to set the option where the Scroll Lock key is used to simulate the Fn key feature. Enable Fn Key Emulation (selected by default)
Fn Lock Options	Allows you to let hot key combinations Fn + Esc toggle the primary behavior of F1–F12, between their standard and secondary functions. If you disable this option, you cannot toggle dynamically the primary behavior of these keys. The available options are: <ul style="list-style-type: none">· Fn Lock. This option is selected by default.· Lock Mode Disable/Standard (selected by default.)· Lock Mode Enable/Secondary

Manageability screen options

Option	Description
MEBx Hotkey	Allows you to specify whether the MEBx Hotkey function should enable, during the system boot. Default Setting: Enable MEBx Hotkey
Fastboot	Allows you to speed up the boot process by bypassing some of the compatibility steps. The options are: <ul style="list-style-type: none">· Minimal (default)· Thorough· Auto
Extended BIOS POST Time	Allows you to create an additional preboot delay. The options are: <ul style="list-style-type: none">· 0 seconds. This option is enabled by default.· 5 seconds· 10 seconds
Full Screen Log	Allows you to specify whether the Full Screen Log (disabled by default).
Warnings and errors option	<ul style="list-style-type: none">· Prompt on warnings and errors (selected by default)· Continue on warnings· Continue on warnings and errors

Virtualization support screen options

Option	Description
Virtualization	Allows you to enable or disable the Intel Virtualization Technology. Enable Intel Virtualization Technology (default).
VT for Direct I/O	Enables or disables the Virtual Machine Monitor (VMM) from utilizing the additional hardware capabilities provided by Intel® Virtualization technology for direct I/O. Enable VT for Direct I/O - enabled by default.

Wireless screen options

Option	Description
Wireless Switch	Allows to set the wireless devices that can be controlled by the wireless switch. The options are: <ul style="list-style-type: none">· WWAN· GPS (on WWAN Module)· WLAN· Bluetooth All the options are enabled by default.  NOTE: For WLAN and WiGig enable or disable controls are tied together and they cannot be enabled or disabled independently.
Wireless Device Enable	Allows you to enable or disable the internal wireless devices. <ul style="list-style-type: none">· WWAN/GPS· WLAN· Bluetooth All the options are enabled by default.

Maintenance screen options

Option	Description
Service Tag	Displays the Service Tag of your computer.
Asset Tag	Allows you to create a system asset tag if an asset tag is not already set. This option is not set by default.
BIOS Downgrade	This controls flashing of the system firmware to previous revisions (selected by default).
Data Wipe	This field allows users to erase the data securely from all internal storage devices. The following is list of devices affected: <ul style="list-style-type: none">· Wwipe on next boot (disabled)· Internal SATA HDD/SSD· Internal M.2 SATA SDD· Internal M.2 PCIe SSD· Internal eMMC
BIOS Recovery	This field allows you to recover from certain corrupted BIOS conditions from a recover file on the user primary hard drive or an external USB key. <ul style="list-style-type: none">· BIOS Recovery from Hard Drive (enabled by default)· BIOS Auto-Recovery· Always perform integrity check (disabled by default)

System Log screen options

Option	Description
BIOS Events	Allows you to view and clear the System Setup (BIOS) POST events.
Thermal Events	Allows you to view and clear the System Setup (Thermal) events.
Power Events	Allows you to view and clear the System Setup (Power) events.

Updating the BIOS in Windows

It is recommended to update your BIOS (System Setup), when you replace the system board or if an update is available. For laptops, ensure that your computer battery is fully charged and connected to a power outlet.

 **NOTE: If BitLocker is enabled, it must be suspended prior to updating the system BIOS, and then re-enabled after the BIOS update is completed.**

1. Restart the computer.
2. Go to **Dell.com/support**.
 - Enter the **Service Tag** or **Express Service Code** and click **Submit**.
 - Click **Detect Product** and follow the instructions on screen.
3. If you are unable to detect or find the Service Tag, click **Choose from all products**.
4. Choose the **Products** category from the list.

 **NOTE: Choose the appropriate category to reach the product page**

5. Select your computer model and the **Product Support** page of your computer appears.
6. Click **Get drivers** and click **Drivers and Downloads**.
The Drivers and Downloads section opens.
7. Click **Find it myself**.
8. Click **BIOS** to view the BIOS versions.
9. Identify the latest BIOS file and click **Download**.
10. Select your preferred download method in the **Please select your download method below** window, click **Download File**.
The **File Download** window appears.
11. Click **Save** to save the file on your computer.
12. Click **Run** to install the updated BIOS settings on your computer.
Follow the instructions on the screen.

System and setup password

Table 2. System and setup password

Password type	Description
System password	Password that you must enter to log on to your system.
Setup password	Password that you must enter to access and make changes to the BIOS settings of your computer.

You can create a system password and a setup password to secure your computer.

 **CAUTION: The password features provide a basic level of security for the data on your computer.**

 **CAUTION: Anyone can access the data stored on your computer if it is not locked and left unattended.**

 **NOTE: System and setup password feature is disabled.**

Assigning a system setup password

You can assign a new **System or Admin Password** only when the status is in **Not Set**.

To enter the system setup, press F2 immediately after a power-on or re-boot.

1. In the **System BIOS** or **System Setup** screen, select **Security** and press Enter.
The **Security** screen is displayed.
2. Select **System/Admin Password** and create a password in the **Enter the new password** field.
Use the following guidelines to assign the system password:
 - A password can have up to 32 characters.
 - The password can contain the numbers 0 through 9.
 - Only lower case letters are valid, upper case letters are not allowed.
 - Only the following special characters are allowed: space, ("), (+), (,), (-), (.), (/), (:), ([), (\), (]), (').
3. Type the system password that you entered earlier in the **Confirm new password** field and click **OK**.
4. Press Esc and a message prompts you to save the changes.
5. Press Y to save the changes.
The computer reboots.

Deleting or changing an existing system setup password

Ensure that the **Password Status** is Unlocked (in the System Setup) before attempting to delete or change the existing System and/or Setup password. You cannot delete or change an existing System or Setup password, if the **Password Status** is Locked.

To enter the System Setup, press F2 immediately after a power-on or reboot.

1. In the **System BIOS** or **System Setup** screen, select **System Security** and press Enter.
The **System Security** screen is displayed.
2. In the **System Security** screen, verify that **Password Status** is **Unlocked**.
3. Select **System Password**, alter or delete the existing system password and press Enter or Tab.
4. Select **Setup Password**, alter or delete the existing setup password and press Enter or Tab.
 **NOTE: If you change the System and/or Setup password, re-enter the new password when prompted. If you delete the System and/or Setup password, confirm the deletion when prompted.**
5. Press Esc and a message prompts you to save the changes.
6. Press Y to save the changes and exit from System Setup.
The computer reboot.

Software

This chapter details the supported operating systems along with instructions on how to install the drivers.

Topics:

- [Operating systems](#)
- [Downloading drivers](#)
- [Downloading the chipset driver](#)
- [Chipset drivers](#)
- [Video Drivers](#)
- [Audio Drivers](#)
- [Network Drivers](#)
- [Input Drivers](#)
- [Other drivers](#)

Operating systems

Table 3. Operating systems

Microsoft Windows	<ul style="list-style-type: none"> • Factory installed Windows 10 Pro–64 bit • Factory installed Windows 10 Home 64 • Factory installed Windows 8.1 Pro 64 DGR (6th generation processor-SkyLake) • Factory installed Windows 7 64 DGR (6th generation processor-SkyLake)
Ubuntu 16.04	Factory installed
Neokylin v6.0 64 bit	Factory installed
RHEL 7.3	Factory installed  NOTE: RHEL operating system is not offered with Intel 6th generation processors.

Downloading drivers

1. Turn on the notebook.
2. Go to **Dell.com/support**.
3. Click **Product Support**, enter the Service Tag of your notebook, and then click **Submit**.

 **NOTE: If you do not have the Service Tag, use the auto detect feature or manually browse for your notebook model.**

4. Click **Drivers and Downloads**.
5. Select the operating system installed on your notebook.
6. Scroll down the page and select the driver to install.
7. Click **Download File** to download the driver for your notebook.
8. After the download is complete, navigate to the folder where you saved the driver file.
9. Double-click the driver file icon and follow the instructions on the screen.

Downloading the chipset driver

1. Turn on the computer.
2. Go to **Dell.com/support**.
3. Click **Product Support**, enter the Service Tag of your computer, and then click **Submit**.

 **NOTE:** If you do not have the Service Tag, use the autodetect feature or manually browse for your computer model.

4. Click **Drivers and Downloads**.
5. Select the operating system installed in your computer.
6. Scroll down the page, expand **Chipset**, and select your chipset driver.
7. Click **Download File** to download the latest version of the chipset driver for your computer.
8. After the download is complete, navigate to the folder where you saved the driver file.
9. Double-click the chipset driver file icon and follow the instructions on the screen.

Chipset drivers

Intel chipset drivers

Verify if the Intel chipset drivers are already installed in the laptop.

Table 4. Intel chipset drivers

Before installation

- System devices
 - ACPI Fixed Feature Button
 - ACPI Lid
 - ACPI Power Button
 - ACPI Processor Aggregator
 - ACPI Sleep Button
 - ACPI Thermal Zone
 - Composite Bus Enumerator
 - High Definition Audio Controller
 - High precision event timer
 - Intel(R) Power Engine Plug-in
 - Intel(R) Serial IO I2C Host Controller - 9D60
 - Intel(R) Serial IO I2C Host Controller - 9D61
 - Intel(R) Serial IO I2C Host Controller - 9D62
 - Intel(R) Serial IO I2C Host Controller - 9D64
 - Legacy device
 - Microsoft ACPI-Compliant Embedded Controller
 - Microsoft ACPI-Compliant System
 - Microsoft System Management BIOS Driver
 - Microsoft UEFI-Compliant System
 - Microsoft Virtual Drive Enumerator
 - Microsoft Windows Management Interface for ACPI
 - Microsoft Windows Management Interface for ACPI
 - NDIS Virtual Network Adapter Enumerator
 - PCI Express Root Complex
 - PCI standard host CPU bridge
 - PCI standard ISA bridge
 - PCI-to-PCI Bridge
 - PCI-to-PCI Bridge
 - PCI-to-PCI Bridge
 - Plug and Play Software Device Enumerator
 - Programmable interrupt controller
 - Remote Desktop Device Redirector Bus
 - System CMOS/real time clock
 - System timer
 - UMBus Root Bus Enumerator

After installation

- System devices
 - ACPI Fixed Feature Button
 - ACPI Lid
 - ACPI Power Button
 - ACPI Processor Aggregator
 - ACPI Sleep Button
 - ACPI Thermal Zone
 - Composite Bus Enumerator
 - Dell Diag Control Device
 - Dell System Analyzer Control Device
 - High Definition Audio Controller
 - High precision event timer
 - Intel(R) 100 Series/C230 Series Chipset Family LPC Controller (CM238) - A154
 - Intel(R) 100 Series/C230 Series Chipset Family PCI Express Root Port #3 - A112
 - Intel(R) 100 Series/C230 Series Chipset Family PCI Express Root Port #5 - A114
 - Intel(R) 100 Series/C230 Series Chipset Family PCI Express Root Port #2 - A111
 - Intel(R) 100 Series/C230 Series Chipset Family PMC - A121
 - Intel(R) 100 Series/C230 Series Chipset Family SMBus - A123
 - Intel(R) 100 Series/C230 Series Chipset Family Thermal subsystem - A131
 - Intel(R) Management Engine Interface
 - Intel(R) Power Engine Plug-in
 - Intel(R) Serial IO I2C Host Controller - A160
 - Intel(R) Serial IO I2C Host Controller - A161
 - Intel(R) Xeon(R) E3 - 1200 v6/7th Gen Intel(R) Core(TM) Host Bridge/DRAM Registers - 5910
 - Intel(R) Xeon(R) E3 - 1200/1500 v5/6th Gen Intel(R) Core(TM) PCIe Controller (x16) - 1901
 - IWD Bus Enumerator
 - Legacy device
 - Microsoft ACPI-Compliant Embedded Controller
 - Microsoft ACPI-Compliant System
 - Microsoft System Management BIOS Driver
 - Microsoft UEFI-Compliant System
 - Microsoft Virtual Drive Enumerator
 - Microsoft Windows Management Interface for ACPI
 - Microsoft Windows Management Interface for ACPI
 - NDIS Virtual Network Adapter Enumerator
 - NFC USB Bus Driver
 - Numeric data processor
 - Pci Bus
 - Plug and Play Software Device Enumerator

Intel management engine interface -MEI drivers

Verify if the Intel management engine interface (MEI) drivers are already installed in the laptop.

Table 5. Intel management engine interface (MEI) drivers

Before installation	After installation
<ul style="list-style-type: none"> Other devices <ul style="list-style-type: none"> Broadcom NFP Broadcom USH w/touch sensor Network Controller PCI Data Acquisition and Signal Processing Controller PCI Data Acquisition and Signal Processing Controller PCI Device PCI Memory Controller PCI Serial Port PCI Simple Communications Controller SM Bus Controller 	<ul style="list-style-type: none"> System devices <ul style="list-style-type: none"> ACPI Fixed Feature Button ACPI Lid ACPI Power Button ACPI Processor Aggregator ACPI Sleep Button ACPI Thermal Zone Composite Bus Enumerator Dell Diag Control Device Dell System Analyzer Control Device High Definition Audio Controller High precision event timer Intel(R) 100 Series/C230 Series Chipset Family LPC Controller (CM238) - A154 Intel(R) 100 Series/C230 Series Chipset Family PCI Express Root Port #3 - A112 Intel(R) 100 Series/C230 Series Chipset Family PCI Express Root Port #5 - A114 Intel(R) 100 Series/C230 Series Chipset Family PCI Express Root Port #2 - A111 Intel(R) 100 Series/C230 Series Chipset Family PMC - A121 Intel(R) 100 Series/C230 Series Chipset Family SMBus - A123 Intel(R) 100 Series/C230 Series Chipset Family Thermal subsystem - A131 Intel(R) Management Engine Interface Intel(R) Power Engine Plug-in Intel(R) Serial IO I2C Host Controller - A160 Intel(R) Serial IO I2C Host Controller - A161 Intel(R) Xeon(R) E3 - 1200 v6/7th Gen Intel(R) Core(TM) Host Bridge/DRAM Registers - 5910 Intel(R) Xeon(R) E3 - 1200/1500 v5/6th Gen Intel(R) Core(TM) PCIe Controller (x16) - 1901

Intel dynamic platform and thermal framework drivers

Verify if the Intel dynamic platform and thermal framework drivers are already installed in the laptop.

Table 6. Intel dynamic platform and thermal framework drivers

Before installation	After installation
<ul style="list-style-type: none"> Other devices <ul style="list-style-type: none"> Network Controller PCI Data Acquisition and Signal Processing Controller PCI Device PCI Device Unknown device Unknown device Unknown device Unknown device Unknown device Unknown device Unknown device Unknown device 	<ul style="list-style-type: none"> Intel(R) Dynamic Platform and Thermal Framework <ul style="list-style-type: none"> Intel(R) Dynamic Platform and Thermal Framework Generic Participant Intel(R) Dynamic Platform and Thermal Framework Generic Participant Intel(R) Dynamic Platform and Thermal Framework Generic Participant Intel(R) Dynamic Platform and Thermal Framework Generic Participant Intel(R) Dynamic Platform and Thermal Framework Generic Participant Intel(R) Dynamic Platform and Thermal Framework Manager Intel(R) Dynamic Platform and Thermal Framework Processor Participant

Intel rapid storage technology- RST drivers

Verify if the Intel rapid storage technology (RST) drivers are already installed in the laptop.

Table 7. Intel rapid storage technology (RST) drivers

Before installation	After installation
<ul style="list-style-type: none"> Storage controllers <ul style="list-style-type: none"> Intel(R) Mobile Express Chipset SATA RAID Controller Microsoft Storage Spaces Controller 	<ul style="list-style-type: none"> Storage controllers <ul style="list-style-type: none"> Intel Chipset SATA RAID Controller Microsoft Storage Spaces Controller

RealTek PCI-E card reader drivers

Verify if the RealTek PCI-E card reader drivers are already installed in the laptop.

Table 8. RealTek PCI-E card reader drivers

Before installation	After installation
<ul style="list-style-type: none"> Other devices <ul style="list-style-type: none"> Network Controller PCI Device PCI Device Unknown device Unknown device 	<ul style="list-style-type: none"> Memory technology devices <ul style="list-style-type: none"> Realtek PCIe CardReader

Video Drivers

UMA graphics drivers

Verify if the UMA graphics drivers are already installed in the laptop.

Table 9. UMA graphics drivers

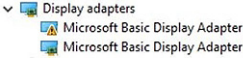
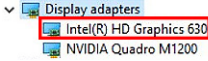
Before installation	After installation
	

NOTE: For Precision 7520/7720, based on the specifications of the system, one of the following Intel HD Graphics drivers will be displayed after installation: P630, 630, P530 or 530.

Discrete graphics drivers

Verify if the Discrete graphics drivers are already installed in the laptop.

Table 10. Discrete graphics drivers

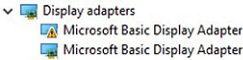
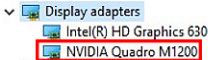
Before installation	After installation
	

NOTE: For Precision 7720, based on the specifications of the system, one of the following graphics drivers will be displayed after installation: AMD Radeon Pro WX 4130, AMD Radeon Pro WX 7100, NVIDIA Quadro M1200, NVIDIA Quadro P3000, NVIDIA Quadro P4000 or NVIDIA Quadro P5000.

Audio Drivers

Realtek audio driver

Verify if the Realtek audio driver are already installed in the laptop.

Table 11. Realtek audio driver

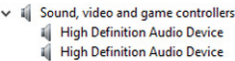
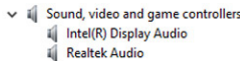
Before installation	After installation
	

Network Drivers

Intel ethernet controller drivers

Verify if the Intel ethernet controller drivers are already installed in the laptop.

Table 12. Intel ethernet controller drivers

Before installation	After installation
<ul style="list-style-type: none">Network adapters<ul style="list-style-type: none">DW5811e Snapdragon™ X7 LTEIntel(R) Ethernet Connection (4) I219-LM	<ul style="list-style-type: none">Network adapters<ul style="list-style-type: none">Intel(R) Dual Band Wireless-AC 8265Bluetooth<ul style="list-style-type: none">Intel(R) Wireless Bluetooth(R)Microsoft Bluetooth EnumeratorMicrosoft Bluetooth LE Enumerator

Wireless and bluetooth drivers

Verify if the Wireless and bluetooth drivers are already installed in the laptop.

- Intel Dual Band Wireless-AC 8265
- Qualcomm Dual Band QCA61X4A

Table 13. Intel Dual Band Wireless-AC 8265 wireless network adapter driver

Before installation	After installation
<ul style="list-style-type: none">Other devices<ul style="list-style-type: none">Network ControllerBluetooth<ul style="list-style-type: none">Generic Bluetooth AdapterMicrosoft Bluetooth EnumeratorMicrosoft Bluetooth LE Enumerator	<ul style="list-style-type: none">Network adapters<ul style="list-style-type: none">Intel(R) Dual Band Wireless-AC 8265Bluetooth<ul style="list-style-type: none">Intel(R) Wireless Bluetooth(R)Microsoft Bluetooth EnumeratorMicrosoft Bluetooth LE Enumerator

Table 14. Qualcomm Dual Band QCA61X4A wireless network adapter driver

Before installation	After installation
<ul style="list-style-type: none">Other devices<ul style="list-style-type: none">Network ControllerBluetooth<ul style="list-style-type: none">Generic Bluetooth AdapterMicrosoft Bluetooth EnumeratorMicrosoft Bluetooth LE Enumerator	<ul style="list-style-type: none">Network adapters<ul style="list-style-type: none">Bluetooth Device (Personal Area Network)Bluetooth Device (RFCOMM Protocol TDI)Qualcomm QCA61x4A 802.11ac Wireless AdapterBluetooth<ul style="list-style-type: none">Microsoft Bluetooth EnumeratorMicrosoft Bluetooth LE EnumeratorQualcomm QCA61x4A Bluetooth 4.1

4G LTE mobile broadband drivers

Verify if the 4G LTE mobile broadband drivers are already installed in the laptop.

Table 15. 4G LTE mobile broadband drivers

Before installation	After installation
<ul style="list-style-type: none">Network adapters<ul style="list-style-type: none">Bluetooth Device (Personal Area Network)Bluetooth Device (RFCOMM Protocol TDI)Dell Wireless 1820 802.11acIntel(R) Ethernet Connection (5) I219-LM	<ul style="list-style-type: none">Network adapters<ul style="list-style-type: none">Bluetooth Device (Personal Area Network)Bluetooth Device (RFCOMM Protocol TDI)DW5811e Snapdragon™ X7 LTE

NOTE: For Precision 7520/7720, based on the specifications of the system, either DW5811e or DW5814e driver will be displayed after installation.

Input Drivers

Touchpad driver

Verify if the Touchpad driver are already installed in the laptop.

Table 16. Touchpad driver

Before installation	After installation
<ul style="list-style-type: none">▼ Mice and other pointing devices<ul style="list-style-type: none">HID-compliant mouse	<ul style="list-style-type: none">▼ Human Interface Devices<ul style="list-style-type: none">Converted Portable Device Control deviceDell Touchpad

Intel thunderbolt controller driver

Verify if the Intel thunderbolt controller driver are already installed in the laptop.

Table 17. Intel thunderbolt controller driver

Before installation	After installation
N/A	<ul style="list-style-type: none">> System devices<ul style="list-style-type: none">Thunderbolt(TM) Controller - 15D9

 **NOTE:** Controller will only be shown in Device Manager when the device connects to your computer.

Other drivers

Intel HID event filter

Verify if the Intel HID event filter driver are already installed in the laptop.

Table 18. Intel HID event filter

Before installation	After installation
<ul style="list-style-type: none">▼ Human Interface Devices<ul style="list-style-type: none">HID-compliant vendor-defined deviceHID-compliant vendor-defined deviceI2C HID Device	<ul style="list-style-type: none">▼ Human Interface Devices<ul style="list-style-type: none">Converted Portable Device Control deviceDell TouchpadHID-compliant consumer control deviceHID-compliant system controllerHID-compliant vendor-defined deviceHID-compliant wireless radio controlsI2C HID DeviceIntel(R) HID Event FilterPortable Device Control deviceUSB Input Device

Troubleshooting

Enhanced Pre-Boot System Assessment — ePSA diagnostics

The ePSA diagnostics (also known as system diagnostics) performs a complete check of your hardware. The ePSA is embedded with the BIOS and is launched by the BIOS internally. The embedded system diagnostics provides a set of options for particular devices or device groups allowing you to:

The ePSA diagnostics can be initiated by the FN+PWR buttons while powering on the computer.

- Run tests automatically or in an interactive mode
- Repeat tests
- Display or save test results
- Run thorough tests to introduce additional test options to provide extra information about the failed device(s)
- View status messages that inform you if tests are completed successfully
- View error messages that inform you of problems encountered during testing

NOTE: Some tests for specific devices require user interaction. Always ensure that you are present at the computer terminal when the diagnostic tests are performed.

Running the ePSA Diagnostics

Invoke diagnostics boot by either of the methods that are suggested below:

1. Power on the computer.
2. As the computer boots, press the F12 key when the Dell logo is displayed.
3. In the boot menu screen, use Up/Down arrow key to select the **Diagnostics** option and then press **Enter**.

NOTE: The Enhanced Pre-boot System Assessment window displays, listing all devices detected in the computer. The diagnostics starts running the tests on all the detected devices.

4. Press the arrow in the lower-right corner to go to the page listing. The detected items are listed and tested.
5. To run a diagnostic test on a specific device, press Esc and click **Yes** to stop the diagnostic test.
6. Select the device from the left pane and click **Run Tests**.
7. If there are any issues, error codes are displayed. Note the error code and contact Dell.

or

8. Shut down the computer.
9. Press and hold the Fn key, while pressing the power button, and then release both.
10. Repeat steps 3–7 above.

Diagnostic LED

This section details the diagnostic features of the battery LED in a notebook.

Instead of beep codes errors are indicated via the bicolor Battery Charge LED. A specific blink pattern is followed by flashing a pattern of flashes in amber, followed by white. The pattern then repeats.

NOTE: The diagnostic pattern will consist of a two digit number being represented by a first group of LED blinks (1 through 9) in amber, followed by a 1.5 second pause with the LED off, and then a second group of LED blinks (1 through 9) in white. This is then followed by a three second pause, with the LED off, before repeating over again. Each LED blink takes 0.5 seconds.

The system will not shutdown when displaying the Diagnostic Error Codes. Diagnostic Error Codes will always supersede any other use of the LED. For instance, on Notebooks, battery codes for Low Battery or Battery Failure situations will not be displayed when Diagnostic Error Codes are being displayed:

Table 19. LED pattern

Blinking pattern		Problem Description	Suggested Resolution
Amber	White		
2	1	processor	processor failure
2	2	system board, BIOS ROM	system board, covers BIOS corruption or ROM error
2	3	memory	no memory/no RAM detected
2	4	memory	memory failure/RAM failure
2	5	memory	invalid memory installed
2	6	system board; chipset	system board/ chipset error
2	7	display	display failure
3	1	RTC power failure	coin-cell battery failure
3	2	PCI/Video	PCI/Video card/chip failure
3	3	BIOS recovery 1	recovery image not found
3	4	BIOS recovery 2	recovery image found but invalid

Battery status lights

If the computer is connected to an electrical outlet, the battery light operates as follows:

Alternately blinking amber light and white light

An unauthenticated or unsupported non-Dell AC adapter is attached to your laptop. Re-plug battery connector, replace battery if the issue reoccurs.

Alternately blinking amber light with steady white light

Temporary battery failure with AC adapter present. Re-plug battery connector, replace battery if the issue reoccurs.

Constantly blinking amber light

Fatal battery failure with AC adapter present. Fatal battery, replace the battery.

Light off

Battery in full charge mode with AC adapter present.

White light on

Battery in charge mode with AC adapter present.

Real Time Clock reset

The Real Time Clock (RTC) reset function allows you to recover your Dell system from **No POST/No Boot/No Power** situations. To initiate the RTC reset on the system make sure system is in a power-off state and is connected to power source. Press and hold the power button for 25 seconds and then release the power button. Go to [how to reset real time clock](#).

i NOTE: If AC power is disconnected from the system during the process or the power button is held longer than 40 seconds, the RTC reset process is aborted.

The RTC reset will reset the BIOS to Defaults, un-provision Intel vPro and reset the system date and time. The following items are unaffected by the RTC reset:

- Service Tag
- Asset Tag
- Ownership Tag

- Admin Password
- System Password
- HDD Password
- TPM on and Active
- Key Databases
- System Logs

The following items may or may not reset based on your custom BIOS setting selections:

- The Boot List
- Enable Legacy OROMs
- Secure Boot Enable
- Allow BIOS Downgrade

Testing memory using ePSA

1. Turn on or restart your computer.
2. Press F12 or press Fn+PWR to invoke the ePSA diagnostics.
The PreBoot System Assessment (PSA) starts on your computer.

 **NOTE: If you wait too long and the operating system logo appears, continue to wait until you see the login screen/desktop screen. Turn off the computer and try again.**

If the memory test results in 25 or less errors, then the RMT basic feature automatically fixes the issues. The test will indicate a pass result since the defect(s) have been removed. If the memory test results in 26 - 50 errors, the RMT basic feature masks the defective memory blocks and results in pass with no memory replacement requirement. If the memory test results in more than 50 errors, then the test is stalled and the result indicates that memory module replacement is required.

Contacting Dell

 **NOTE:** If you do not have an active Internet connection, you can find contact information on your purchase invoice, packing slip, bill, or Dell product catalog.

Dell provides several online and telephone-based support and service options. Availability varies by country and product, and some services may not be available in your area. To contact Dell for sales, technical support, or customer service issues:

1. Go to **Dell.com/support**.
2. Select your support category.
3. Verify your country or region in the **Choose a Country/Region** drop-down list at the bottom of the page.
4. Select the appropriate service or support link based on your need.